





Consulta nuestras Novedades

Bombilla	Pagina 1-14
Tubo	Pagina 15-16 
Foco Mini	Pagina 17-19
Downlight	Pagina 20-23 
Cardan	Pagina 24-26
Panel	Pagina 27-35
Campana	Pagina 36
Foco Exterior	Pagina 37-41 
Foco Carril	Pagina 42-51
Tira LED	Pagina 52-56
Neon	Pagina 57
Regleta	Pagina 58-63 
Plafon Exterior	Pagina 64-69
FOB China	Pagina 70-75
Lampara decorativa	Pagina 76 

Bombilla LED Vela

- 40-LED-C30-6W-WH 5609651 066226
- 40-LED-C30-6W-YE 5609651 066233
- 40-LED-C30-8W-WH 5609651 071664
- 40-LED-C30-8W-YE 5609651 066219
- 40-LED-CAL30-6W-YE 5609651 066202



Descripcion

E14 AC175-250V 50/60Hz

RA>80; PF>0.6

6W/8W

470LM/680LM

6400K / 3000K

$\Phi=37\text{MM.H}=98\text{MM}/\Phi=37\text{MM.H}=131\text{MM}$

Para dónde se usa

Para cualquier lampara decorativa o plafon que lleva Casquillo E14

Para substituir las bombillas antiguas de encandescencia

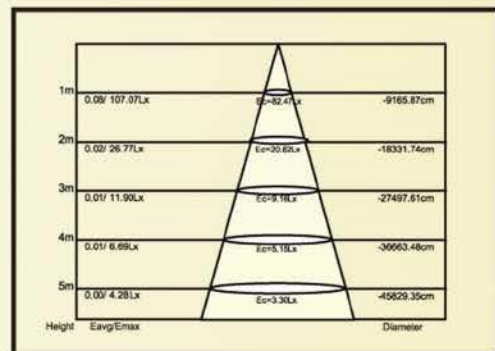
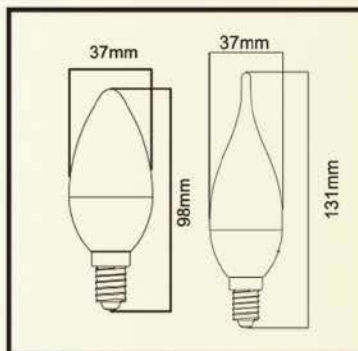
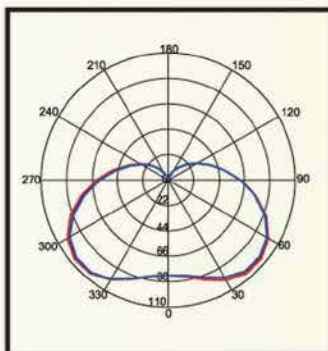



Bombilla LED Esferica

40-LED-B45-E14-6W-WH 5609651 066257

40-LED-B45-E14-6W-YE 5609651 066264

40-LED-B45-E27-6W-WH 5609651 066271

40-LED-B45-E27-6W-YE 5609651 066288

40-LED-B45-E27-8W-WH 5609651 071671

40-LED-B45-E27-8W-YE 5609651 066240

Descripcion

E14/E27 AC175-250V 50/60Hz

RA>80; PF>0.6

6W/8W

470LM/680LM

6400K / 3000K

$\Phi=45\text{MM.H}=80\text{MM}/\Phi=45\text{MM.H}=75\text{MM}$

Para dónde se usa

Para cualquier lampara decorativa que lleva Casquillo E14/E27

Para substituir las bombillas antiguas de encandescencia

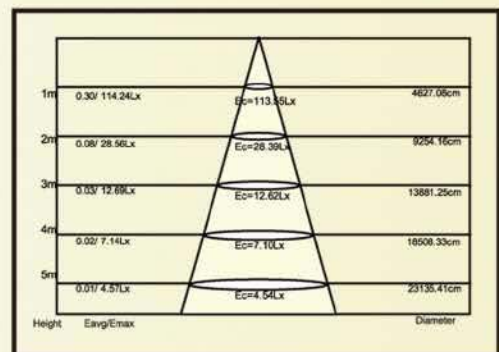
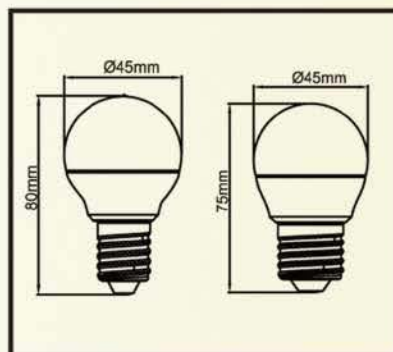
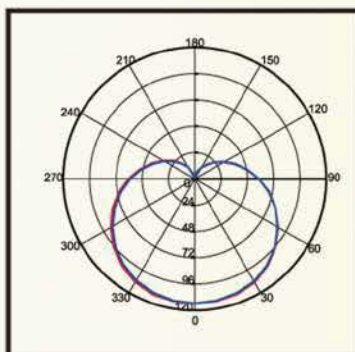



Bombilla LED A60

40-LED-A60-7W-WH	5609651 071756
40-LED-A60-7W-NW	5609651 067735
40-LED-A60-7W-YE	5609651 071749
40-LED-A60-10W-WH	5609651 067742
40-LED-A60-10W-NW	5609651 067759
40-LED-A60-10W-YE	5609651 062372
40-LED-A60-13W-WH	5609651 071732
40-LED-A60-13W-NW	5609651 067766
40-LED-A60-13W-YE	5609651 071725

Descripcion

E27 AC175-250V 50/60Hz

RA>80; PF>0.6

7W/10W/13W

500LM/900LM/1200LM

6400K /4000K/3000K

$\Phi=60\text{MM.H}=108\text{MM}$

Para dónde se usa

Para cualquier lampara decorativa o plafon que lleva Casquillo E27

Para substituir las bombillas antiguas de encandescencia

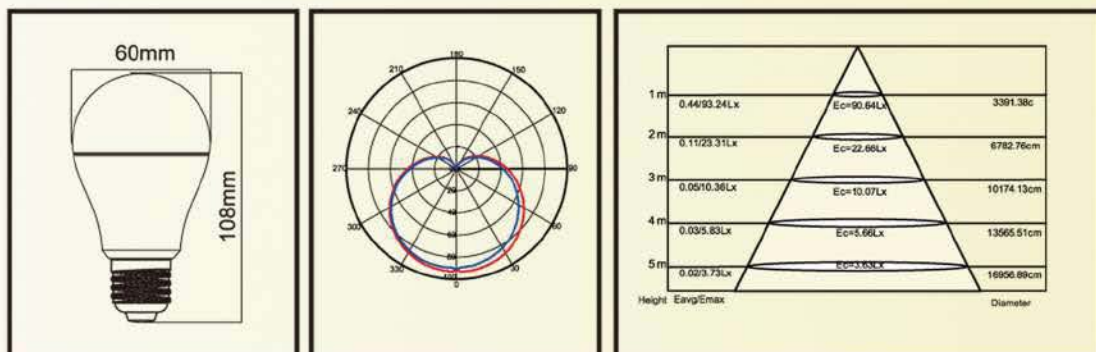



Bombilla LED GU10

40-LED-GU10-4W-WH	5609651 067865
40-LED-GU10-4W-NW	5609651 067834
40-LED-GU10-5W5-WH	5609651 067827
40-LED-GU10-5W5-NW	5609651 067810
40-LED-GU10-5W5-YE	5609651 067803
40-LED-GU10-7W-WH	5609651 067797
40-LED-GU10-7W-NW	5609651 067780
40-LED-GU10-7W-YE	5609651 067773

Descripcion

GU10 AC175-250V 50/60Hz

RA>80; PF>0.6

4W/5.5W/7W

290LM/420LM/550LM

6400K /4000K/3000K

$\Phi=50\text{MM.H}=55\text{MM}$

Para dónde se usa

Para cualquier lampara decorativa o foco que lleva Casquillo GU10

Para substituir las bombillas antiguas de encandescencia

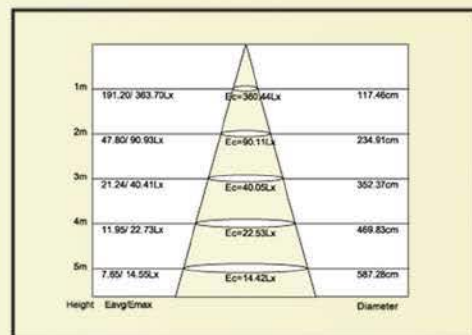
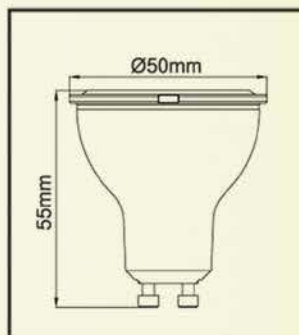
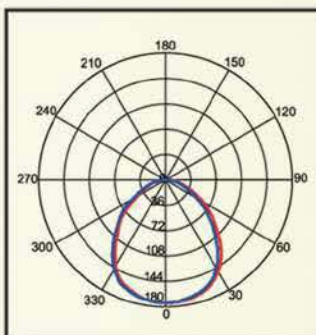



Bombilla LED GX53

40-LED-GX53-8W-NW 5609651 074245

40-LED-GX53-8W-WW 5609651 074238

Descripcion

GX53 AC220-240V 50/60Hz

RA>80; PF>0.6

8W

640LM

4000K/3000K

$\Phi=75\text{MM.H}=28\text{MM}$

Para dónde se usa

Para cualquier Foco o Aro que lleva Casquillo GX53

Para substituir las bombillas antiguas de bajo consumo normal

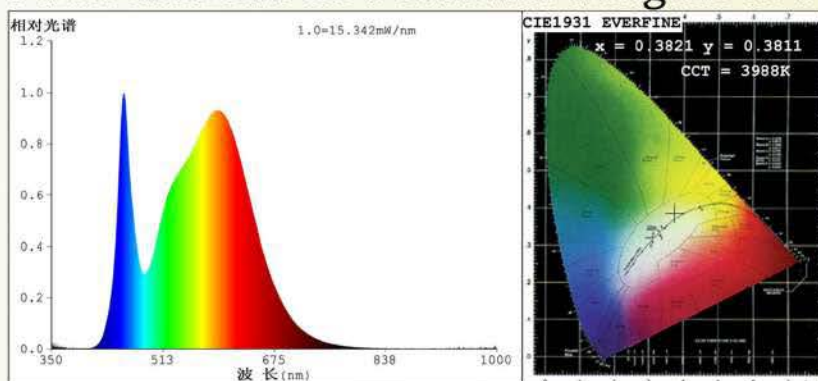
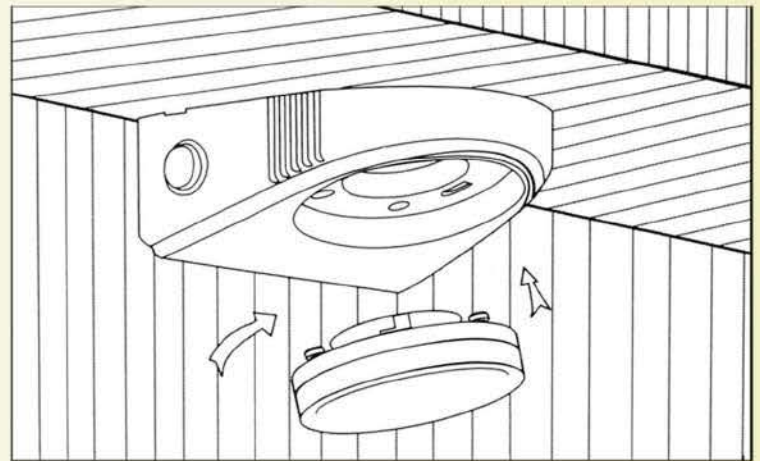



Bombilla LED Filamento

41-G95-2703-TEC 5609651 074115

Descripcion

E27 AC220-240V 50/60Hz

RA>80; PF>0.6

3W

200LM

2700K

$\Phi=95\text{MM.H}=138\text{MM}$

Para dónde se usa

Para cualquier lampara decorativa o colgante que lleva Casquillo E27

Para substituir las bombillas antiguas de encandescencia

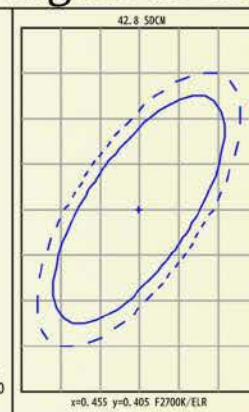
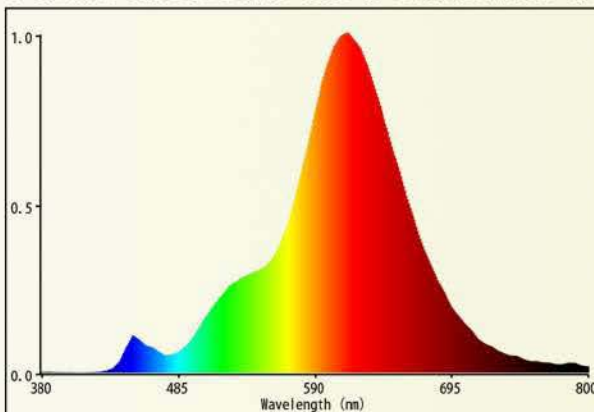



Bombilla LED Filamento

41-ST64-2703-TEC 5609651 074108

Descripcion

E27 AC220-240V 50/60Hz

RA>80; PF>0.6

3W

200LM

2700K

$\Phi=64\text{MM.H}=145\text{MM}$

Para dónde se usa

Para cualquier lampara decorativa o colgante que lleva Casquillo E27

Para substituir las bombillas antiguas de encandescencia

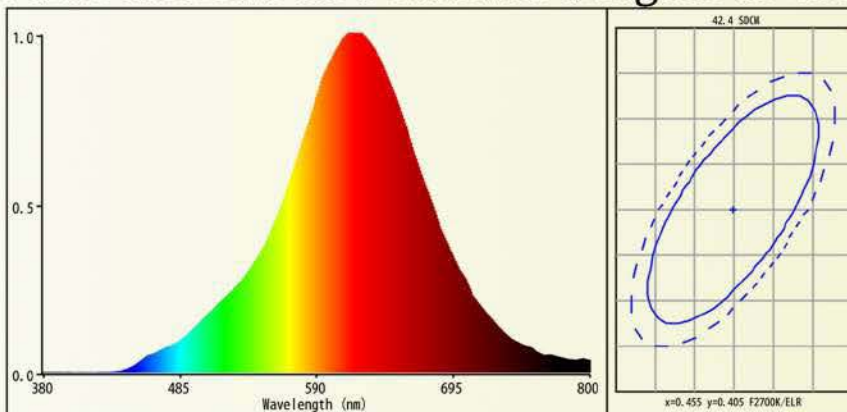



Bombilla G4 PC

40-G4-PC-1W5-NW 5609651 074580

Descripcion

DC12V IP20

RA>80; PF>0.7

1.5W

120LM

4000K

12x38MM

Para dónde se usa

Para el uso de Lampara Decorativa,Foco Pequeño etc.

Para substituir bombilla de G4 de Halogeno

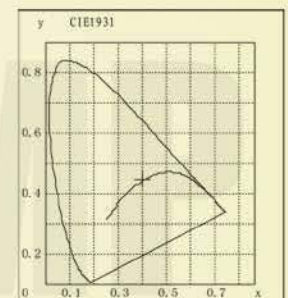
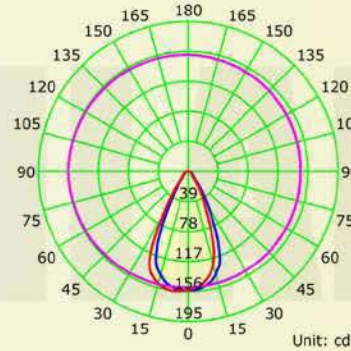
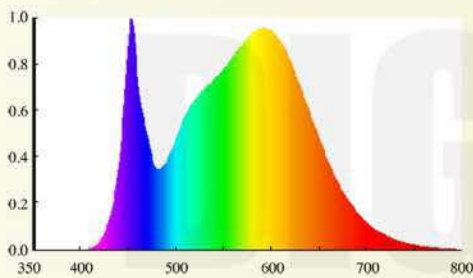
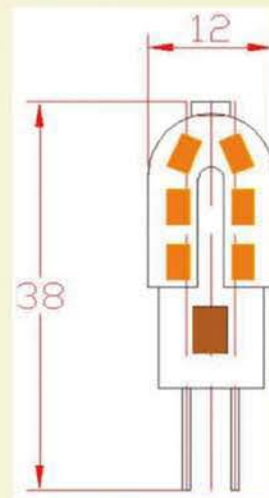



Bombilla G4 COB

40-G4-COB-2W-NW 5609651 074566

40-G4-COB-2W-WW 5609651 071817

Descripcion

DC12V IP20

RA>80; PF>0.7

2W

160LM

4000K/3000K

10x36MM

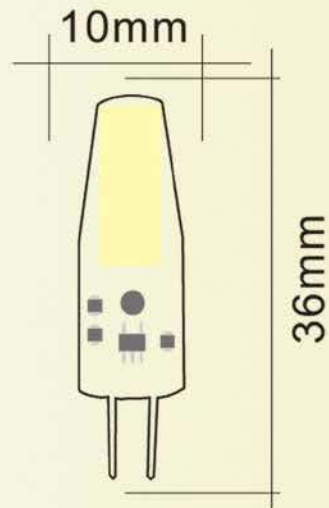

Para dónde se usa

Para el uso de Lampara Decorativa,Foco Pequeño etc.

Para substituir bombilla de G4 de Halogeno

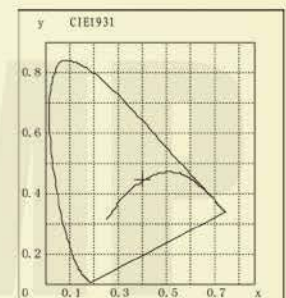
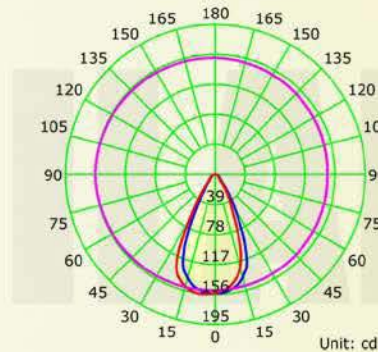
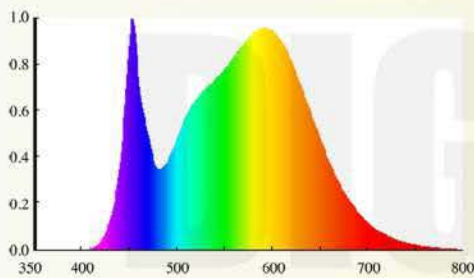



Bombilla G9 PC

40-G9-PC-2W-NW 5609651 074597

Descripcion

AC220-240V 50/60Hz IP20

RA>80; PF>0.7

2W

190LM

4000K

16x12x47MM

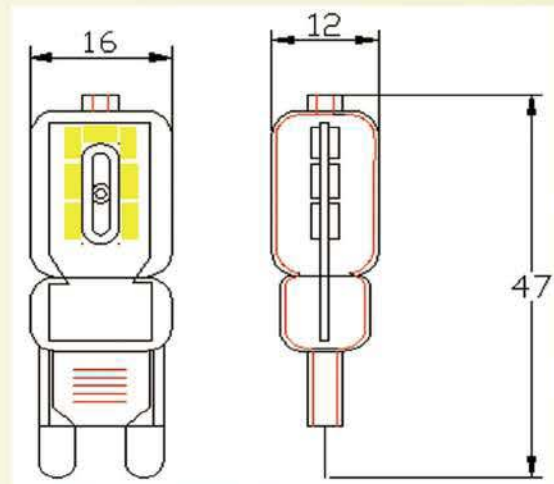

Para dónde se usa

Para el uso de Lampara Decorativa, Foco Pequeño etc.

Para substituir bombilla de G9 de Halogeno

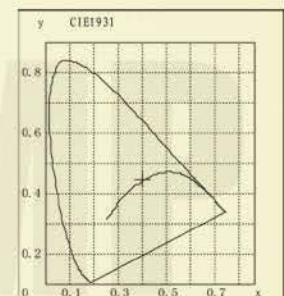
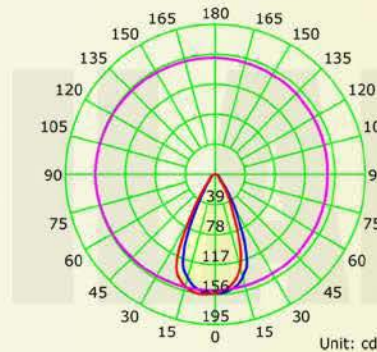
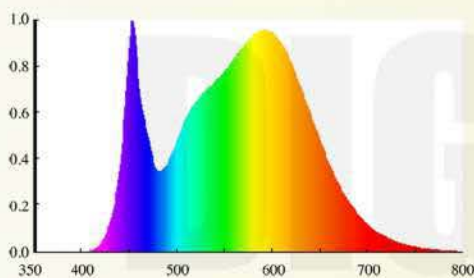



Bombilla G9 PC

40-G9-SUP-3W-NW 5609651 075617

40-G9-SUP-3W-WW 5609651 075600

Descripcion

AC220-240V 50/60Hz IP20

RA>80; PF>0.7

3W

310LM

4000K/3000K

16x12x47MM

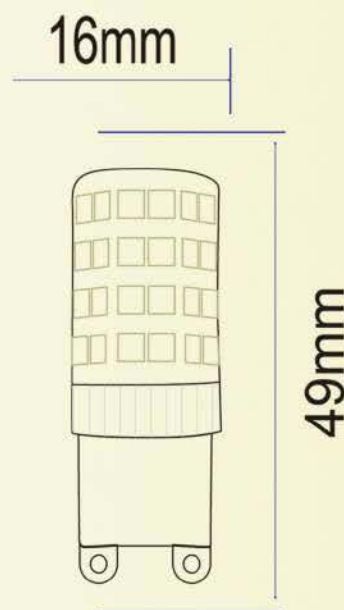

Para dónde se usa

Para el uso de Lampara Decorativa,Foco Pequeño etc.

Para substituir bombilla de G9 de Halogeno

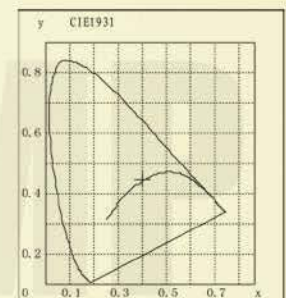
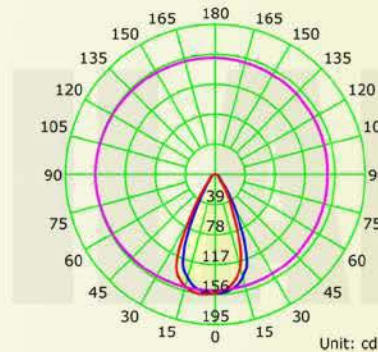
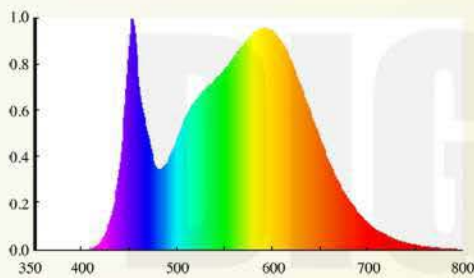

RoHS conform

Bombilla LED AR111

40-AR111-12V-15W-NW-TEC 5609651 074283

40-AR111-12V-15W-WW-TEC 5609651 074276

40-AR111-GU10-15W-NW-TEC 5609651 074269

40-AR111-GU10-15W-WW-TEC 5609651 074252



Descripcion

DC12V/AC220-240V 50/60Hz

RA>80; PF>0.6

15W 24°

900LM

4000K/3000K

Φ=111MM.H=70MM

Para dónde se usa

Para cualquier Foco o Aro que lleva Bombilla AR111

Para substituir las bombillas antiguas de bajo consumo normal

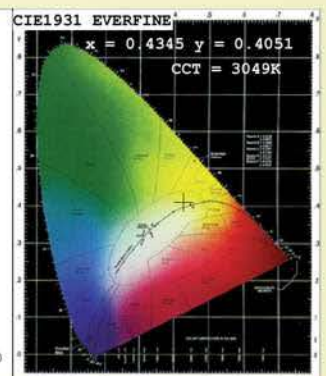
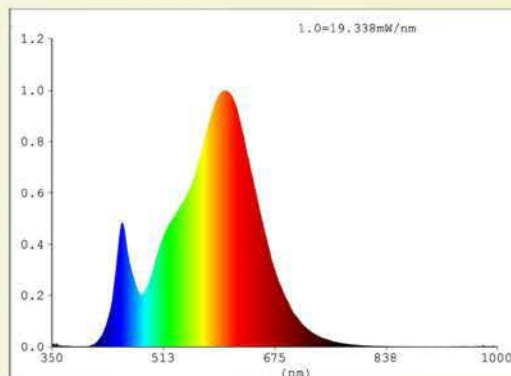
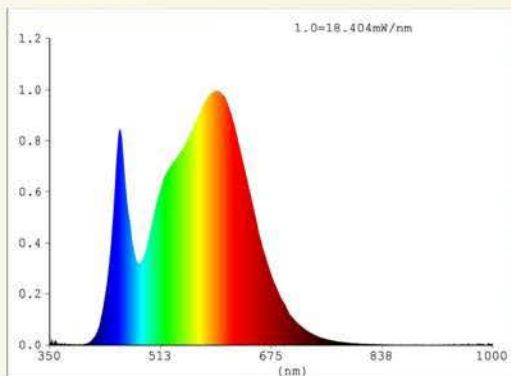



Bombilla LED AR111

57-AR111-COB-12W-NW	5609651 070254
57-AR111-COB-18W-NW	5609651 070261
57-AR111-COB-24W-NW	5609651 070278
57-AR111-COB-24W-WW	5609651 070285
57-AR111-COB-30W-NW	5609651 070308
57-AR111-COB-30W-WW	5609651 070292

Descripcion

DC12V/AC220-240V 50/60Hz

RA>80; PF>0.6;24°

12W/18W/24W/30W

960/1440/1900/2400LM

4000K/3000K

Φ=111MM.H=61MM



Para dónde se usa

Para cualquier Foco o Aro que lleva Bombilla AR111

Para substituir las bombillas antiguas de bajo consumo normal

Luminous Intensity Distribution Curve(cd/klm)

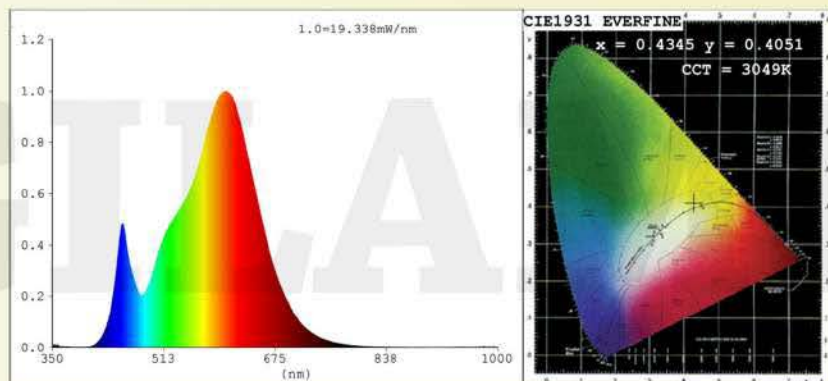
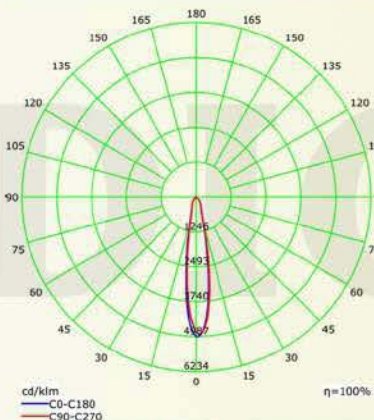



Bombilla LED R7S

40-J78-R7S-6W-NW 5609651 075907

40-J118-R7S-10W-NW 5609651 071092

Descripcion

AC220-240V 50/60Hz IP20

RA>80; PF>0.6

6W/10W

500LM/900LM

4000K

23x78/118MM

Para dónde se usa

Para el uso de Foco con casquillo R7S para tienda,joyeria etc.

Para substituir bombilla de R7S de Halogeno

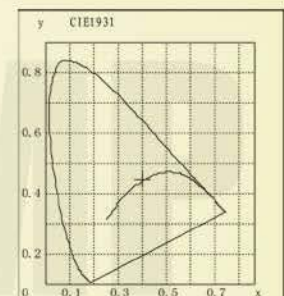
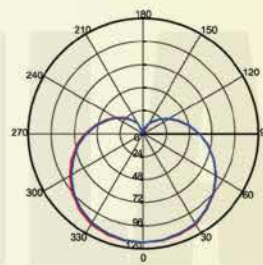
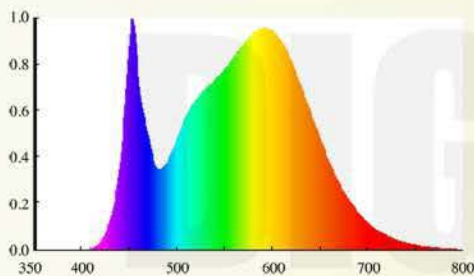



LED Tubo Nano

50-LED-T8N-1-0M6-6K/4K

50-LED-T8N-1-0M9-6K/4K

50-LED-T8N-1-1M2-6K/4K

50-LED-T8N-1-1M5-6K/4K

50-LED-T8N-2-0M6-6K/4K

50-LED-T8N-2-0M9-6K

50-LED-T8N-2-1M2-6K/4K

50-LED-T8N-2-1M5-6K

Descripcion

AC220-240V 50/60Hz

RA>80; PF>0.7;220°

9W/12W/18W/21W

95LM/W Conexión 1 y 2 Lados

6400K/4000K

Φ=28MM.H=600MM/900MM/1200MM/1500MM

Para dónde se usa

Para cualquier Pantalla que lleva Tubo T8

Para substituir los Tubos T8 de Fluorescente normal

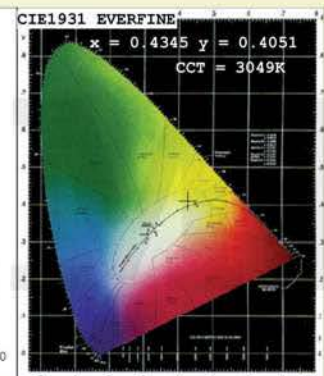
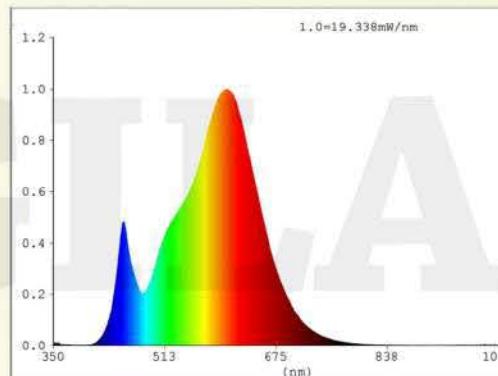
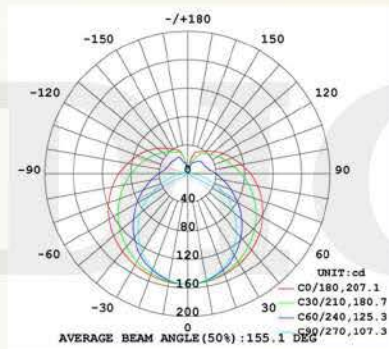



LED Tubo Aluminio

- 50-LED-T8-1-0M6-6K/4K/3K
- 50-LED-T8-1-0M9-6K/4K/3K
- 50-LED-T8-1-1M2-6K/4K/3K
- 50-LED-T8-1-1M5-6K/4K/3K
- 50-LED-T8-2-0M6-6K/4K/3K
- 50-LED-T8-2-0M9-6K/4K/3K
- 50-LED-T8-2-1M2-6K/4K/3K
- 50-LED-T8-2-1M5-6K/4K/3K

Descripcion

AC220-240V 50/60Hz

RA>80; PF>0.7;160°

9W/12W/18W/21W

95LM/W Conexión 1 y 2 Lados

6400K/4000K/3000K

Φ=28MM.H=600MM/900MM/1200MM/1500MM

Para dónde se usa

Para cualquier Pantalla que lleva Tubo T8

Para substituir los Tubos T8 de Fluorescente normal

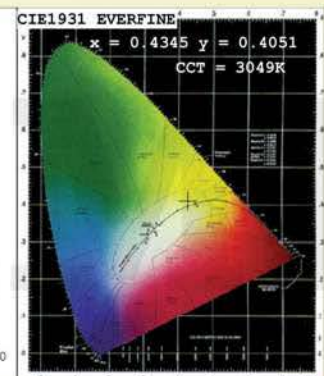
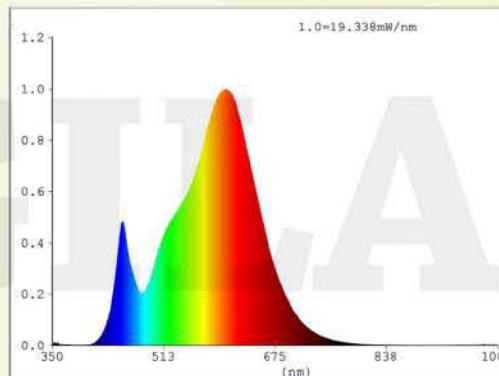
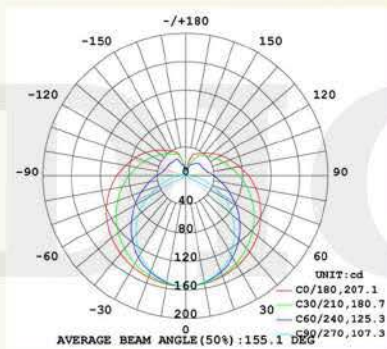

NOVEDADES

Tubo LED Aluminio



50-LED-T8-1-24H-1M2-6K

Descripción:

AC100-240V 50-60Hz

RA> 80 PF>0.95 IP20(Interior) 160º Grados de apertura

18W

2.000 Lm

6.400K (Luz blanca/fría)

Duración de encendido al día 24H

Para donde se usa:

Tubo de gran calidad, perfecto para sustituir tubos fluorescentes T8 de 36W que estén las 24H encendidas, como por ejemplo garajes, ascensores, naves, ...

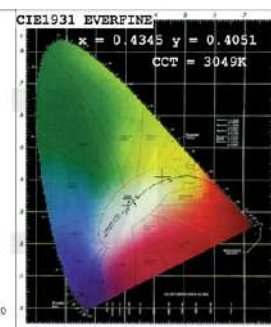
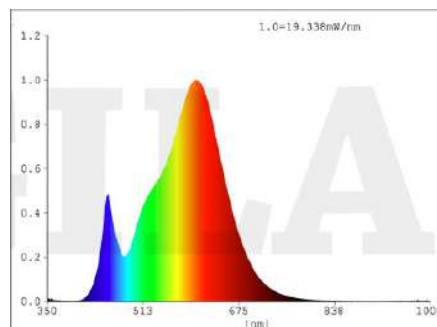
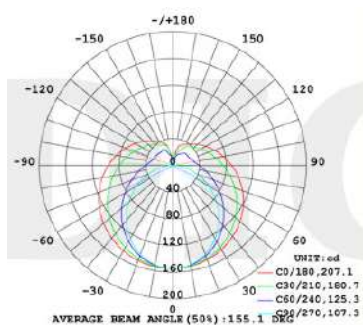



Foco LED Empotrar

55-L1-1W-WH 5609651 074610

55-L1-1W-WW 5609651 074627

Descripcion

DC12V IP20

RA>80; PF>0.5;30°

1W

60LM

6400K/3000K

21x26MM

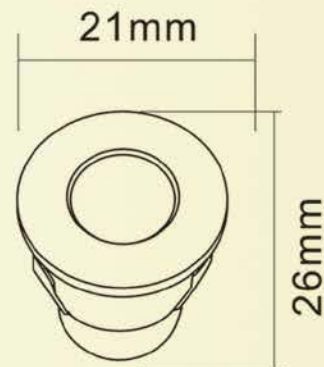

Para dónde se usa

Para el uso de Decoración de Armáριο,Mueble etc.

Para substituir Foco de Halogeno

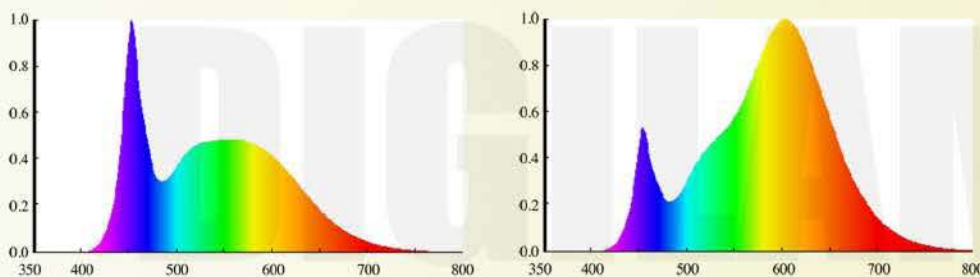



Foco LED Empotrar

55-L2-3W-WH 5609651 074634

55-L2-3W-WW 5609651 074641

Descripcion

DC12V IP20

RA>80; PF>0.5;60°

3W

200LM

6400K/3000K

41x26MM

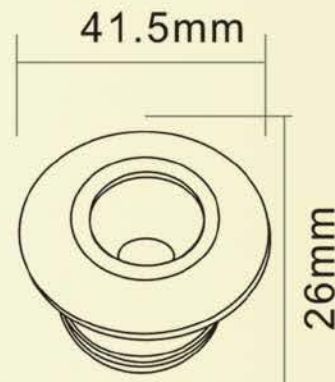

Para dónde se usa

Para el uso de Decoración de Armáριο,Mueble etc.

Para substituir Foco de Halogeno

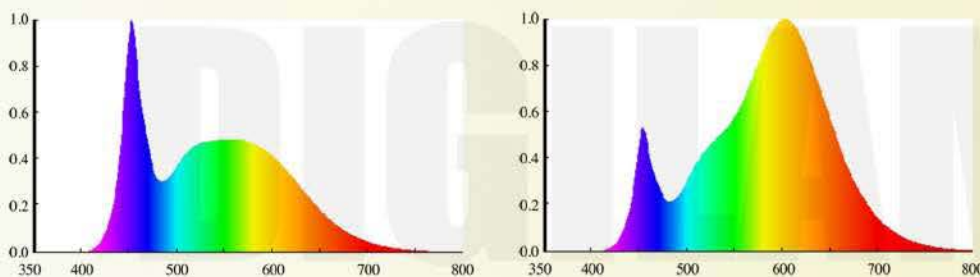



Downlight IP65

57-8265-5W-WH-IP65 5609651 073903

57-8265-5W-NW-IP65 5609651 073897

Descripcion

AC220-240V 50/60Hz IP65

RA>80; PF>0.6

5W

350LM

6500K / 4000K

$\Phi=82\text{MM.H}=50\text{MM.Hueco}=70\text{MM}$



Para dónde se usa

Para el uso de Porche, Terraza, Cuarto de baño, Spa.

Para substituir cualquier aparato que le entre humedad.

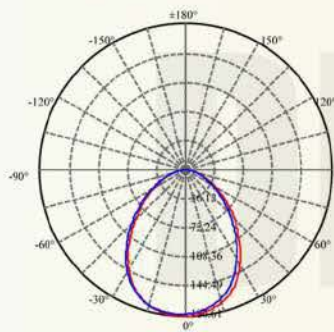

Illuminance at a Distance

Distance (m)	Center Beam LUX	Beam Width	
		V	H
2m	44.52 LUX	3.9m	3.8m
4m	11.13 LUX	7.8m	7.7m
6m	4.95 LUX	11.7m	11.5m
8m	2.78 LUX	15.6m	15.3m
10m	1.78 LUX	19.5m	19.2m
12m	1.24 LUX	23.4m	23.0m

Vert.Spread:38.6 Horiz.Spread:87.6

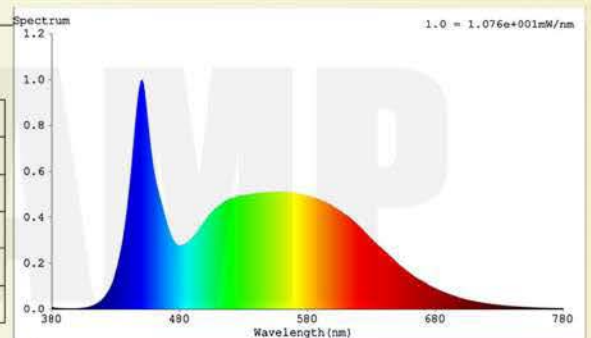

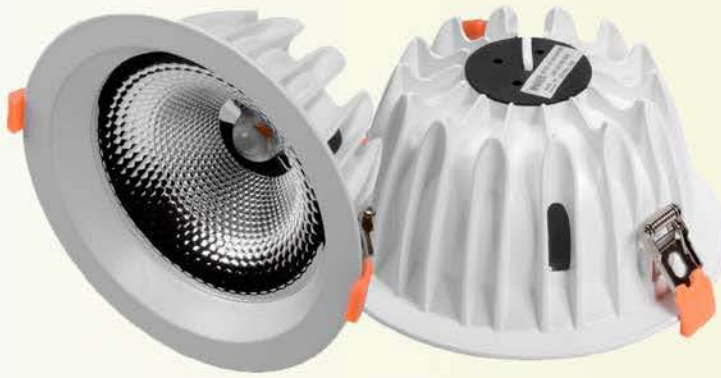

Downlight LED COB

57-LED-1997-30W-6K 5609651 075303
 57-LED-1997-30W-3K 5609651 075280

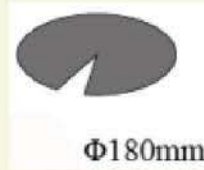
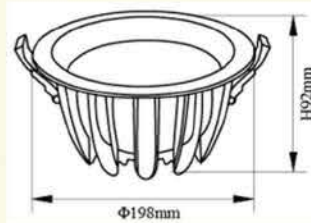

Descripcion

AC180-250V 50/60Hz

RA>80; PF>0.9;IP20;40grados

30W

2500LM

6000K/3000K

198x92MM

Para dónde se usa

Para Hotel,oficina,tienda,concesionario etc.

Para substituir los downlights de halogeno o bajo consumo

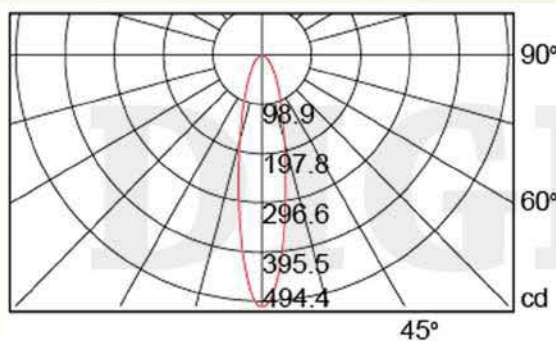

90°	1m	494.40	233.76
	2m	123.60	467.51
	3m	54.93	701.27
	4m	30.90	935.03
	5m	19.78	1168.78





Downlight LED COB

57-X5004A-12W-WH4K	5609651 075822
57-X5004A-12W-WH3K	5609651 075815
57-X5004B-18W-WH4K	5609651 075839
57-X5004B-18W-WH3K	5609651 075846
57-X5004C-35W-WH4K	5609651 075860
57-X5004C-35W-WH3K	5609651 075853

Descripcion

AC220-240V 50/60Hz

RA>80; PF>0.9;IP20;24grados

12W/18W/35W

830LM/1300LM/2800LM

4000K/3000K

96x76MM/125x100MM/164x131MM

Para dónde se usa

Para Hotel,oficina,tienda,concesionario etc.

Para substituir los downlights de halogeno o bajo consumo

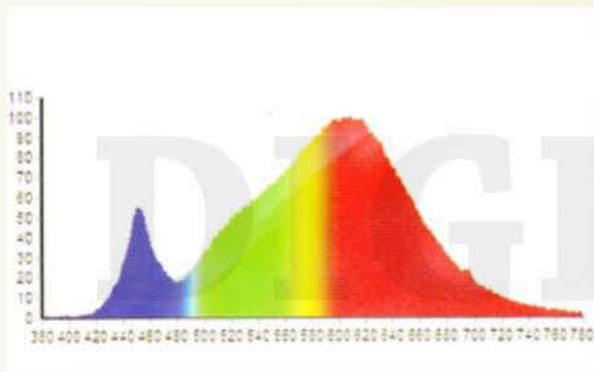
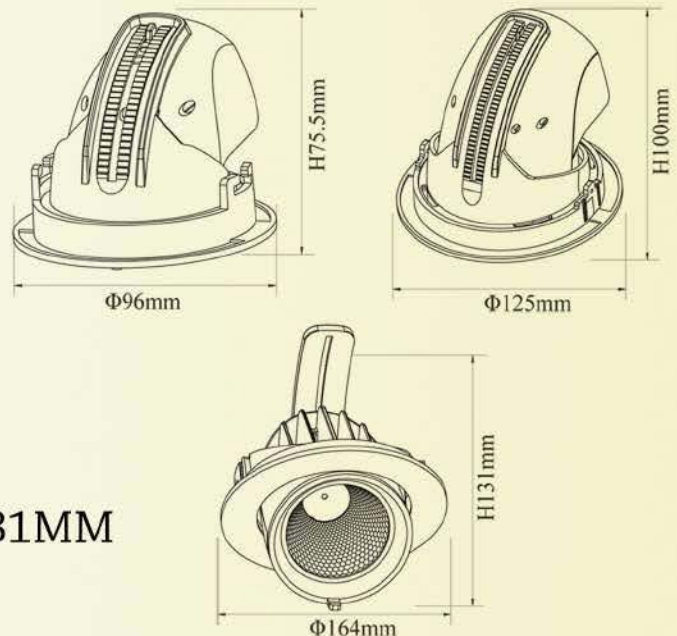

Luminous Intensity Distribution Curve(cd/klm)

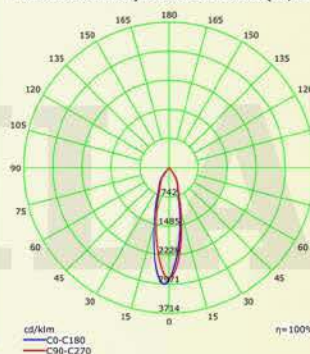

Illuminance at a Distance

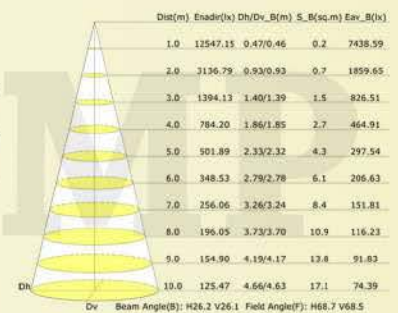



Downlight LED COB

57-X5004D-50W-WH4K

5609651 075556

57-X5004D-50W-WH3K

5609651 075563

Descripcion

AC220-240V 50/60Hz

RA>80; PF>0.9;IP20;24grados

50W

4592LM

4000K/3000K

200x170MM

Para dónde se usa

Para Hotel,oficina,tienda,concesionario etc.

Para substituir los downlights de halogeno o bajo consumo

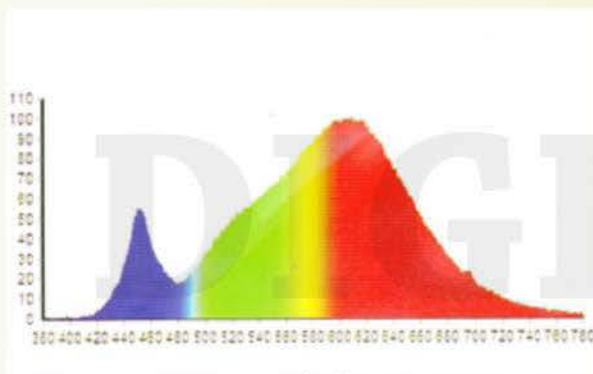
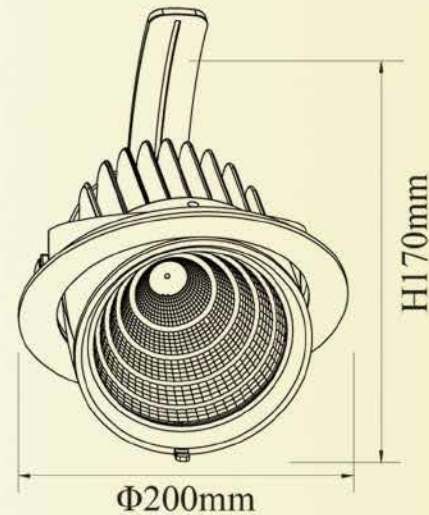

Luminous Intensity Distribution Curve(cd/klm)

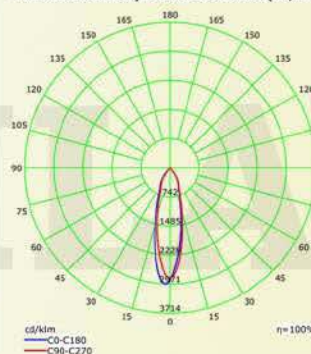

Illuminance at a Distance

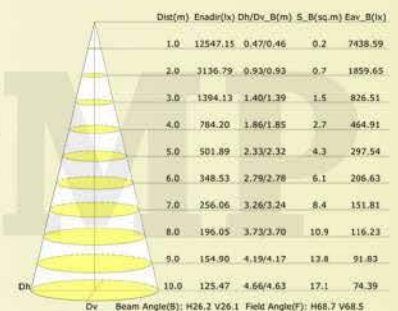



Downlight LED COB

57-LED-2935-50W-WH4K

5609651 075532

57-LED-2935-50W-WH3K

5609651 075549

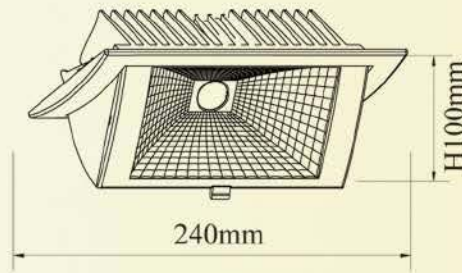

Descripcion

AC220-240V 50/60Hz

RA>80; PF>0.9;IP20;75grados

50W

4592LM

4000K/3000K

240x100x105MM

Para dónde se usa

Para Hotel, oficina, tienda, concesionario etc.

Para substituir los downlights de halogeno o bajo consumo

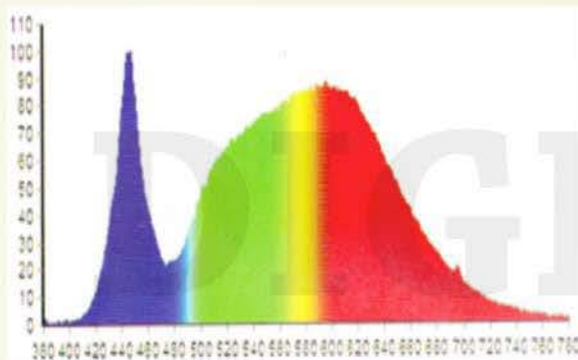

Luminous Intensity Distribution Curve(cd/klm)

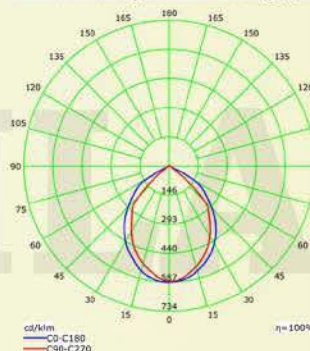

Iluminance at a Distance

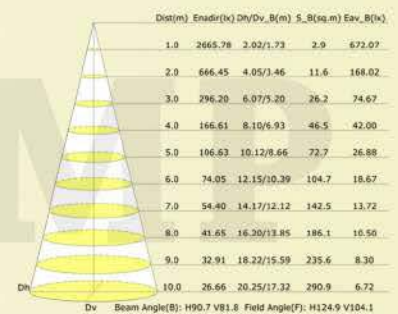

Cardan LED

57-X195-40W-WH4K 5609651 076584



Descripcion

AC220-240V 50/60Hz

RA>80; PF>0.9;IP20;40grados

Chip CREE,Drive Philips

40W, 4000LM

4000K

195x110MM

Para dónde se usa

Para Hotel,oficina,tienda,concesionario etc.

Para substituir los downlights de halogeno o bajo consumo

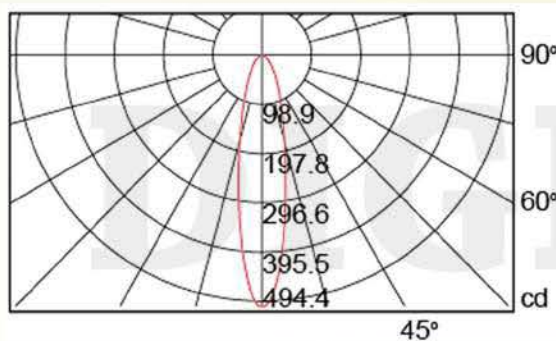

90°	1m	494.40	233.76
	2m	123.60	467.51
	3m	54.93	701.27
	4m	30.90	935.03
60°	5m	19.78	1168.78
		cd	



45°

Cardan LED

57-LED-X160-12x2-NW 5609651 065922

57-LED-X180-18x2-NW 5609651 065939

57-LED-X110-30x2-NW 5609651 065946



Descripcion

AC220-240V 50/60Hz

RA>80; PF>0.6;24°

12W/18W/30W X2

2160LM/3250LM/5500LM

4000K

Φ=210x106x80/265x135x108/352x187x112MM

Para dónde se usa

Para cualquier Tienda de Ropa o Hotel etc.

Para substituir los Cardan de Halogenuro Metalico

Luminous Intensity Distribution Curve(cd/klm)

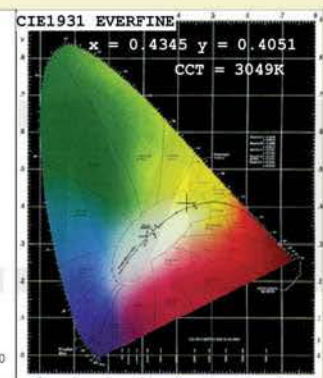
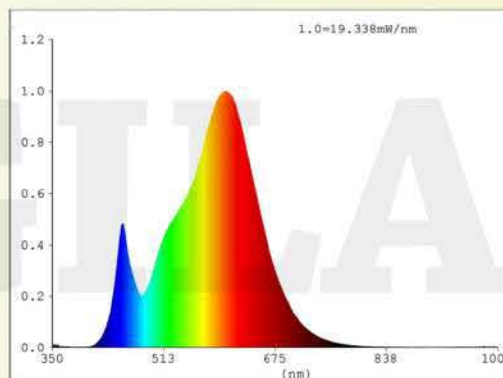
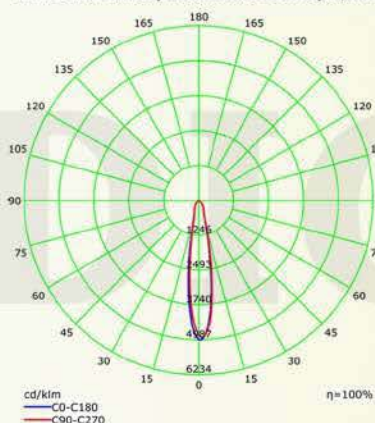

Cardan LED



57-LED-X110-30x1-NW	5609651 070233
57-LED-X110-30x1-WW	5609651 072722
57-LED-X110-30x3-NW	5609651 070186
57-LED-X110-30x3-WW	5609651 070179

Descripcion

AC220-240V 50/60Hz

RA>80; PF>0.6;24°

30W/90W

2500LM/7500LM

4000K/3000K

Φ=187x187/497x187MM.H=112MM



Para dónde se usa

Para cualquier Tienda de Ropa o Hotel etc.

Para substituir los Cardan de Halogenuro Metalico

Luminous Intensity Distribution Curve(cd/klm)

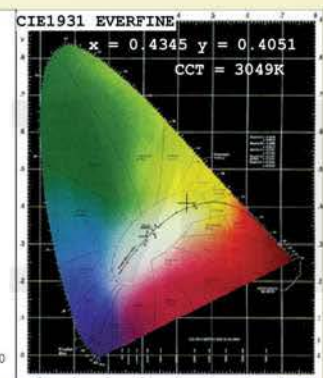
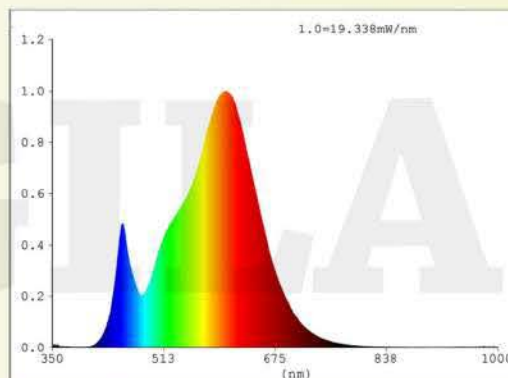
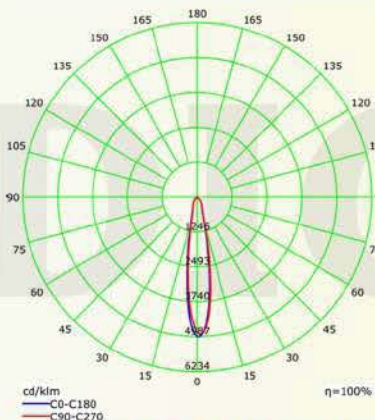



Panel Extraplano

57-LED-DW085-5W-R-WH6K/4K/3K
57-LED-DW120-6W-R-WH6K/4K/3K
57-LED-DW170-12W-R-WH6K/4K/3K
57-LED-DW225-18W-R-WH6K/4K/3K
57-LED-DW300-24W-R-WH6K/4K

Descripcion

AC100-240V 50/60Hz IP20

RA>80; PF>0.7; 120°

5W/6W/12W/18W/24W

85LM/W

6400K / 4000K/3000K

85/120/170/225/300MM x 13MM.

Para dónde se usa

Para el uso de Casa,Oficina,Colegio,etc.

Para substituir los downlights de fluorescente.

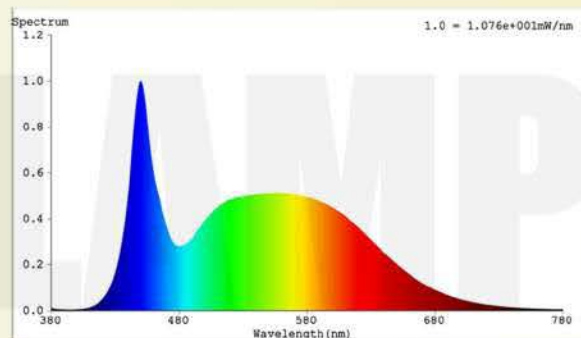
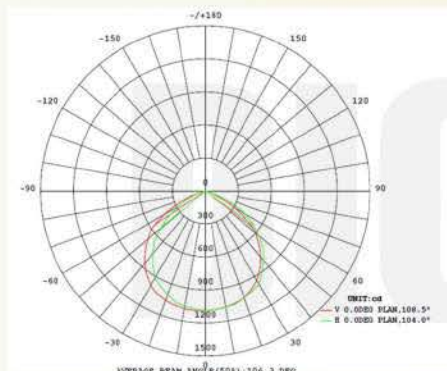



Panel Extraplano

57-LED-DW085-5W-R-SH4K

57-LED-DW120-6W-R-SH4K

57-LED-DW170-12W-R-SH4K

57-LED-DW225-18W-R-SH6K/4K

Descripcion

AC100-240V 50/60Hz IP20

RA>80; PF>0.7; 120°

5W/6W/12W/18W

85LM/W

6400K / 4000K/3000K

85/120/170/225MM x 13MM.

Para dónde se usa

Para el uso de Casa,Oficina,Colegio,etc.

Para substituir los downlights de fluorescente.

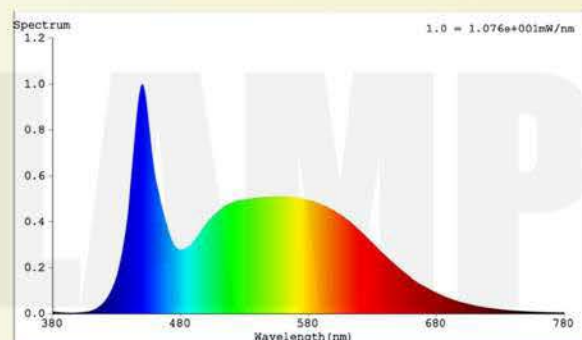
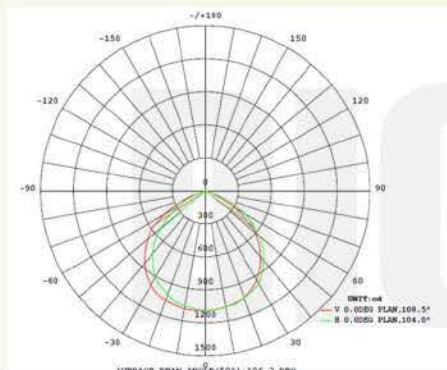

NOVEDADES

Downlight LED



Descripción:

AC85-265V 50-60Hz

RA> 80 PF>0.9 IP20 120º Grados de apertura

24W

2.400LM

6.400K (Luz blanca-fría) y 4.200K (Luz natural-día)

Medida exterior: 225 x 30 mm

Medida corte: 205mm

LED-5730-24H-24W-6K

LED-5730-24H-24W-4K

Para donde se usa:

Downlight gracias a su placa y driver ya que puede estar encendido las 24h perfecto para oficinas, zonas de trabajo, naves, ...

Sustituye los antiguos downlight de bajo consumo.



Panel Extraplano

57-LED-DW085-5W-Q-WH6K/4K/3K

57-LED-DW120-6W-Q-WH6K/4K/3K

57-LED-DW170-12W-Q-WH6K/4K/3K

57-LED-DW225-18W-Q-WH6K/4K/3K

57-LED-DW300-24W-Q-WH4K

Descripcion

AC100-240V 50/60Hz IP20

RA>80; PF>0.7; 120°

5W/6W/12W/18W/24W

85LM/W

6400K / 4000K/3000K

85/120/170/225/300MM x 13MM.

Para dónde se usa

Para el uso de Casa,Oficina,Colegio,etc.

Para substituir los downlights de fluorescente.

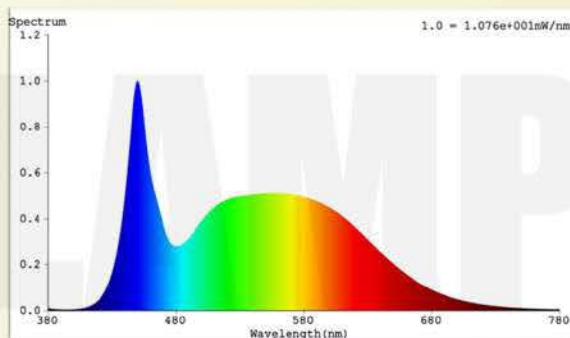
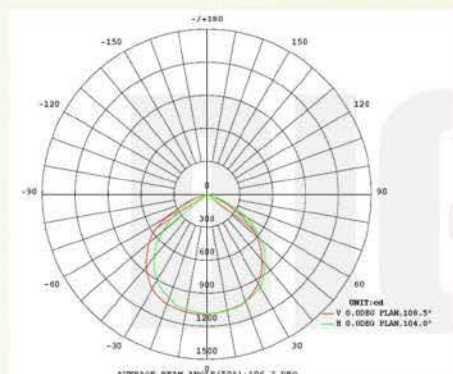

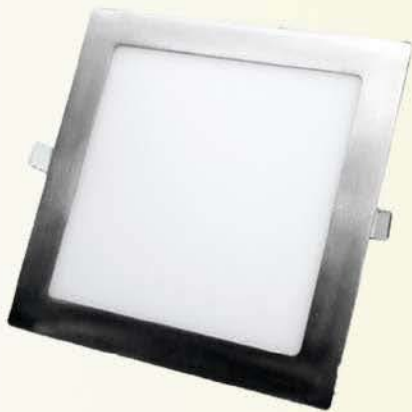

Panel Extraplano

57-LED-DW085-5W-Q-SH4K

57-LED-DW225-18W-Q-SH4K

Descripcion

AC100-240V 50/60Hz IP20

RA>80; PF>0.7; 120°

5W/6W/12W/18W

85LM/W

6400K / 4000K/3000K

85/120/170/225MM x 13MM.

Para dónde se usa

Para el uso de Casa,Oficina,Colegio,etc.

Para substituir los downlights de fluorescente.

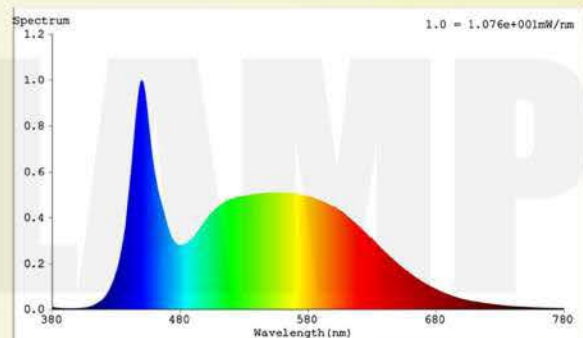
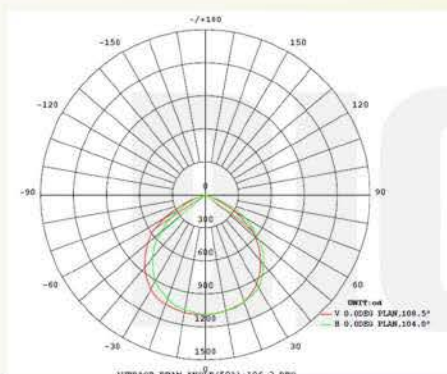



Plafon Extraplano

57-LED-2835-6W-R-WH6K/4K/3K
57-LED-2835-12W-R-WH6K/4K/3K
57-LED-2835-18W-R-WH6K/4K/3K
57-LED-2835-24W-R-WH6K/4K/3K

Descripcion

AC100-240V 50/60Hz IP20

RA>80; PF>0.7; 120°

6W/12W/18W/24W

85LM/W

6400K / 4000K/3000K

120/170/225/300MM x 40MM.

Para dónde se usa

Para el uso de Casa,Oficina,Colegio,etc.

Para substituir los plafones de fluoescente.

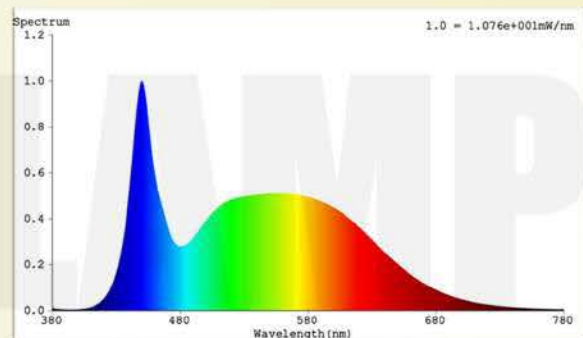
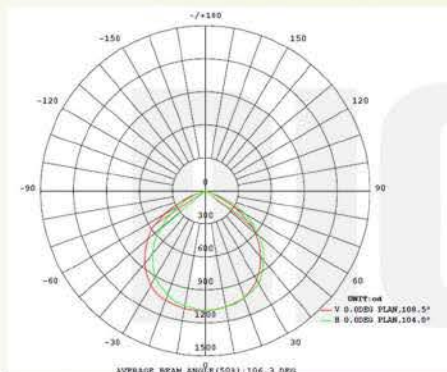



Plafon Extraplano

57-LED-2835-6W-Q-WH6K/4K/3K

57-LED-2835-12W-Q-WH6K/4K/3K

57-LED-2835-18W-Q-WH6K/4K/3K

57-LED-2835-24W-Q-WH6K/4K/3K

Descripcion

AC100-240V 50/60Hz IP20

RA>80; PF>0.7; 120°

6W/12W/18W/24W

85LM/W

6400K / 4000K/3000K

120/170/225/300MM x 40MM.

Para dónde se usa

Para el uso de Casa,Oficina,Colegio,etc.

Para substituir los plafones de fluoescente.

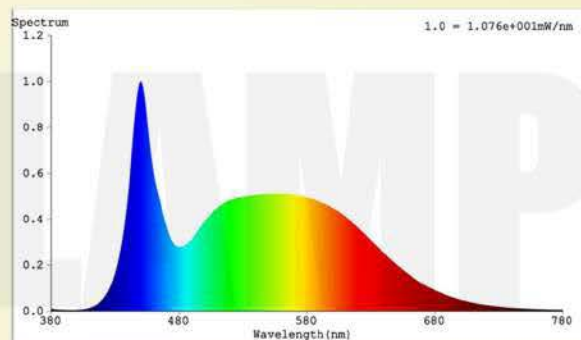
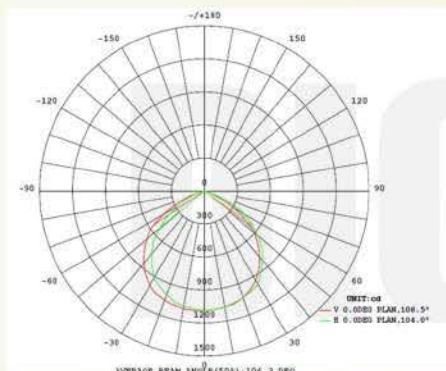

RoHS conform



Panel Extraplano

57-LED-PLFE6060-36W-WH6K

5609651 075730

57-LED-PLFE6060-36W-WH4K

5609651 075723

Descripcion

AC220-240V 50/60Hz IP20

RA>70; PF>0.6

36W

3050LM

6400K / 4000K

595 x 595MM.H=13MM.

Para dónde se usa

Para el uso de Techo Astro de Oficina, Colegio, etc.

Para substituir las luminarias de fluorescente.

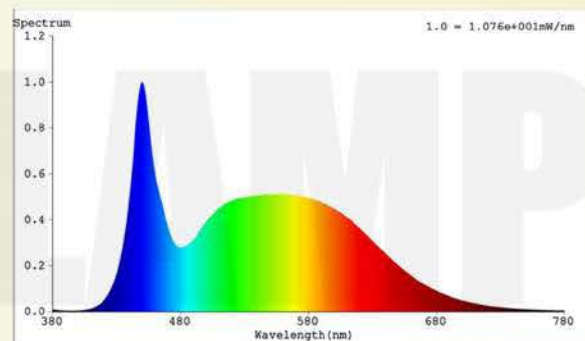
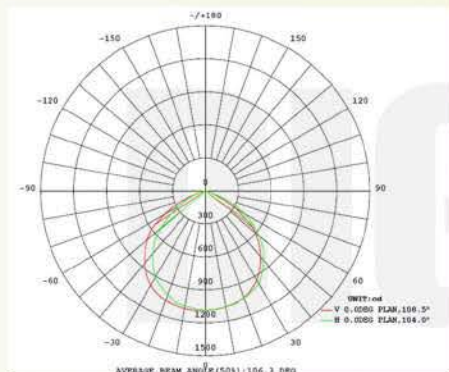

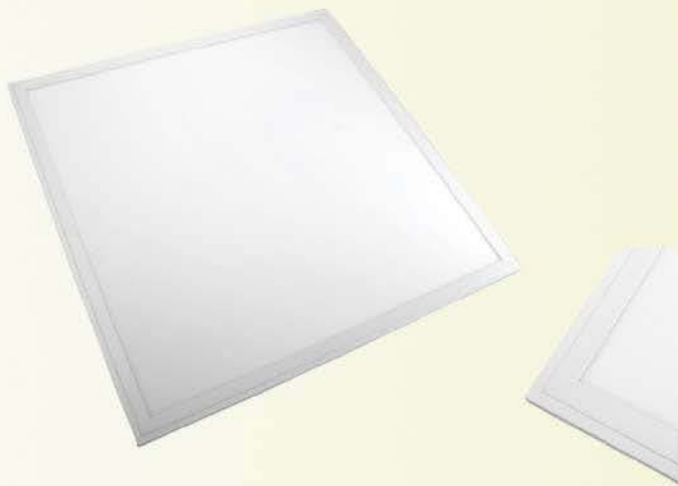

Panel Extraplano

57-LED-PLF6060-45W-WH6K

5609651 075754

57-LED-PLF6060-45W-WH4K

5609651 075747

Descripcion

AC100-240V 50/60Hz IP20

RA>80; PF>0.9

45W

4200LM

6400K / 4000K

595 x 595MM.H=13MM.

Para dónde se usa

Para el uso de Techo Astro de Oficina, Colegio, etc.

Para substituir las luminalias de fluorescente.

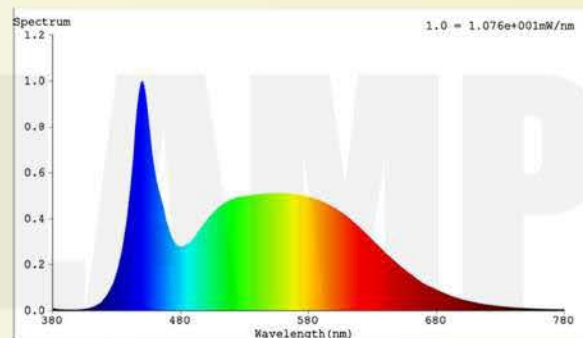
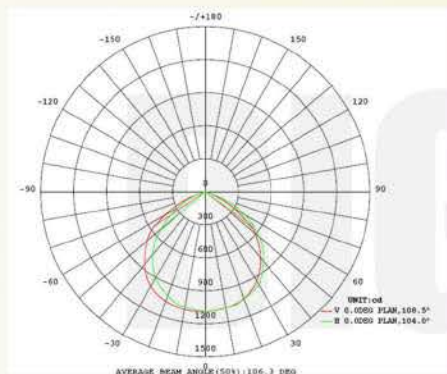

Panel Extraplano

57-LED-PLF30120-40W-WH6K

5609651 076560

57-LED-PLF30120-40W-WH4K

5609651 076577

Descripcion

AC220-240V 50/60Hz IP20

RA>80; PF>0.9

40W

4550LM

6000K / 4000K

295 x 1195MM.H=10.5MM.

Para dónde se usa

Para el uso de Techo Astro de Oficina, Colegio, etc.

Para substituir las luminalias de fluorescente.

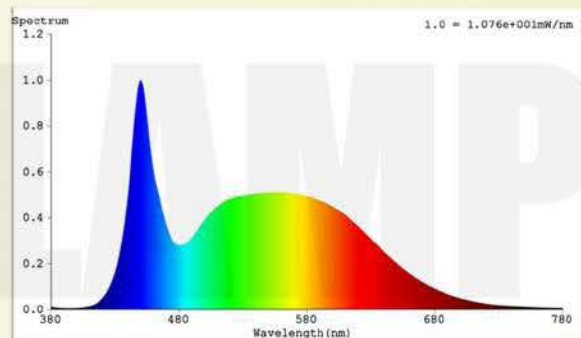
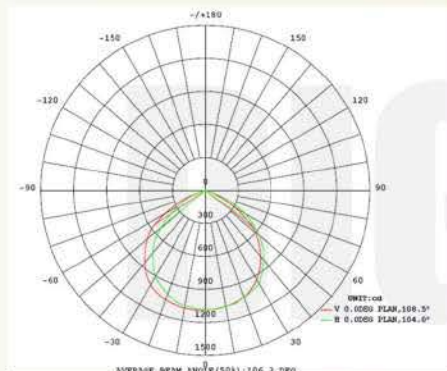



Campana Industria LED

57-ALU31-BH-100W-WH6K	5609651 075211
57-ALU31-BH-150W-WH6K	5609651 075204
57-ALU31-BH-200W-WH6K	5609651 075228

Descripcion

AC150-260V 50/60Hz

RA>80; PF>0.6

100W/150W/200W

85LM/W

6000K 100°

Φ=430MM.H=350MM/Φ=430MM.H=400MM/Φ=480MM.H=400MM

Para dónde se usa

Para Nave Industria

Para substituir las campanas industrias de Halogenuro Metalico

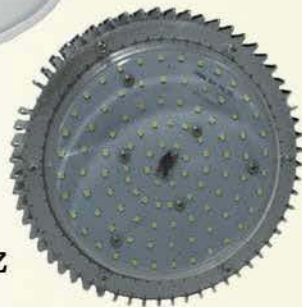

Luminous Intensity Distribution Curve(cd/klm)

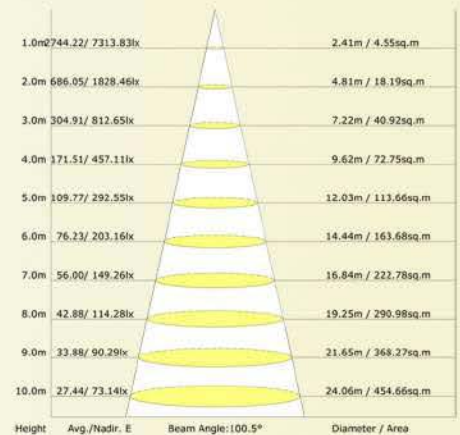
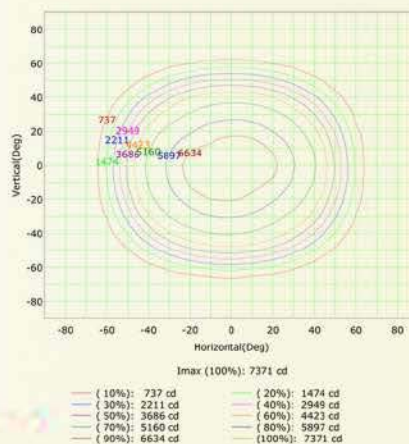
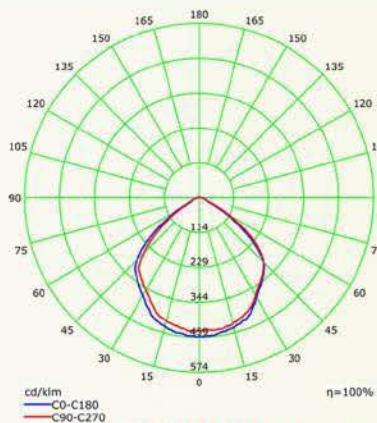



Foco LED Exterior

57-FL4-10W-WH-SUPER	5609651 074290
57-FL4-20W-WH-SUPER	5609651 074306
57-FL4-30W-WH-SUPER	5609651 071091
57-FL4-30W-WW-SUPER	5609651 074320
57-FL4-50W-WH-SUPER	5609651 071107
57-FL4-50W-WW-SUPER	5609651 074337
57-FL4-80W-WH-SUPER	5609651 071114
57-FL4-80W-WW-SUPER	5609651 074344
57-FL4-100W-WH-SUPER	5609651 071121
57-FL4-100W-WW-SUPER	5609651 074351
57-FL4-200W-WH-SUPER	5609651 071138
57-FL4-200W-WW-SUPER	5609651 074368

Descripcion

AC176-264V 50/60Hz

RA>80; PF>0.9;IP65;120grados

10W/20W/30W/50W/80W/100W/200W

85LM/W

6400K/3000K

129x109/182x153/225x184/274x220/330x273/330x273/510x413MM

Para dónde se usa

Para naves,fachadas,campos etc.

Para substituir los proyectores de halogenuro metálico

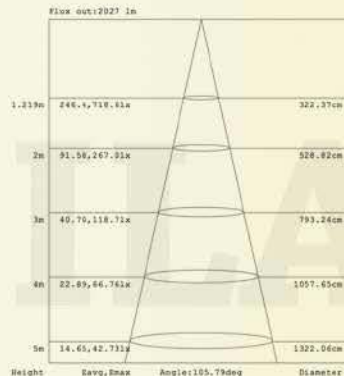
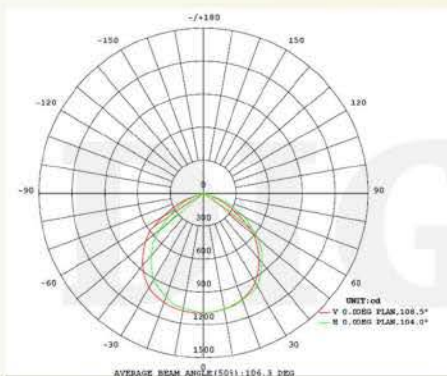



Foco LED Exterior

57-FL4-20W-WH-SENSOR

5609651 074405

57-FL4-30W-WH-SENSOR

5609651 074412

Descripcion

AC90-264V 50/60Hz

RA>80; PF>0.9;IP65;120grados

20W/30W

1400LM/2100LM

6400K

267x157x105/315x193x107MM

Para dónde se usa

Para naves,fachadas,campos etc.

Para substituir los proyectores de halogenuro metálico

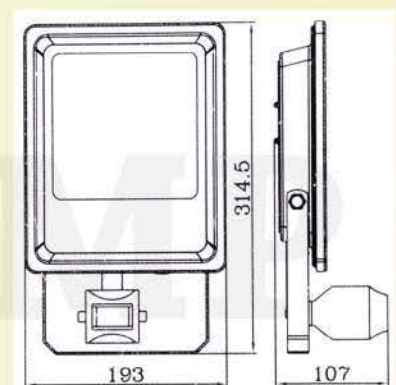
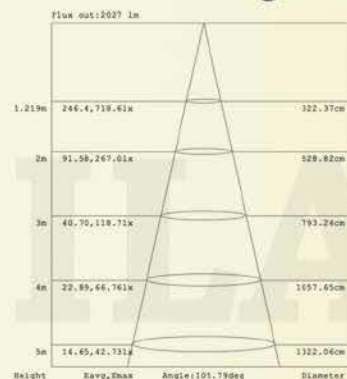
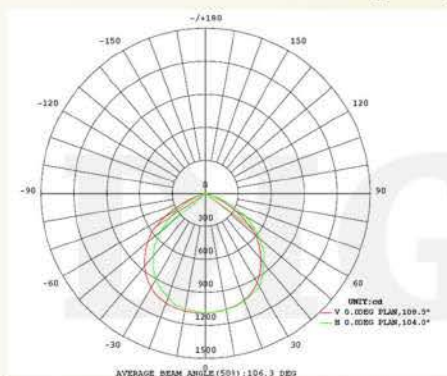



Foco LED Exterior

57-FL4-30W-WH-TATI

5609651 074429

57-FL4-50W-WH-TATI

5609651 074436

Descripcion

AC90-264V 50/60Hz

RA>80; PF>0.9;IP65;120grados

30W/50W

2100LM/3500LM

6400K

400x300x220/470x360x225MM

Para dónde se usa

Para naves,obras,ferias,campos etc.

Para substituir los proyectores de halogenuro metálico

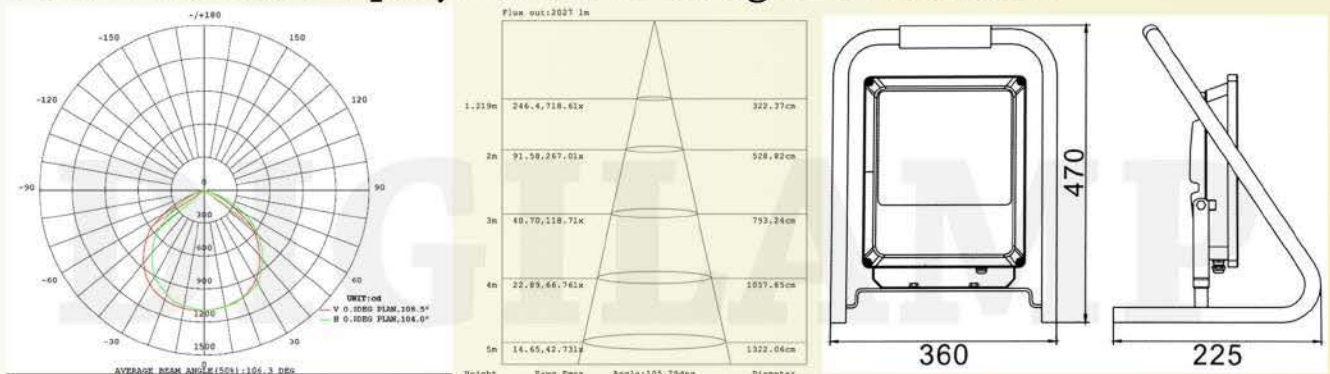



Foco LED Exterior

57-FL4-10W-RGB-SUPER	5609651 074375
57-FL4-30W-RGB-SUPER	5609651 074382

Descripcion

AC90-264V 50/60Hz

RA>80; PF>0.9;IP65;120grados

10W/30W

1400LM/2100LM

RGB

122x157x45/250x193x50MM

Para dónde se usa

Para naves,fachadas,campos etc.

Para substituir los proyectores de halogenuro metálico

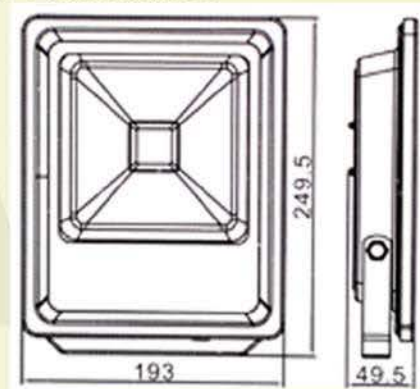
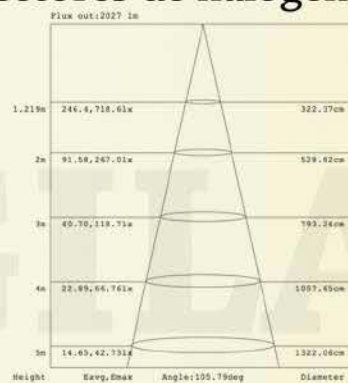
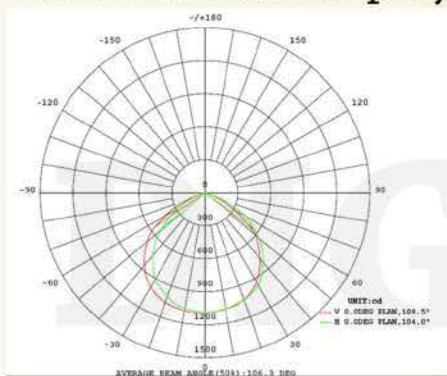

NOVEDADES

Foco LED Exterior



57-JY-200W-RGB
5609651 076683



57-JY-400W-RGB
5609651 076690

Descripción:

220V 50-60Hz

RA> 80 PF>0.9 IP65 60º Grados de apertura

200W y 400W

80Lm/W

RGB Automático

320x420x93mm y 350x620x95mm

Para donde se usa:

Decoración de fachadas, naves industriales, discotecas, eventos, ...

Sustituye al proyector de halogenuro metálico

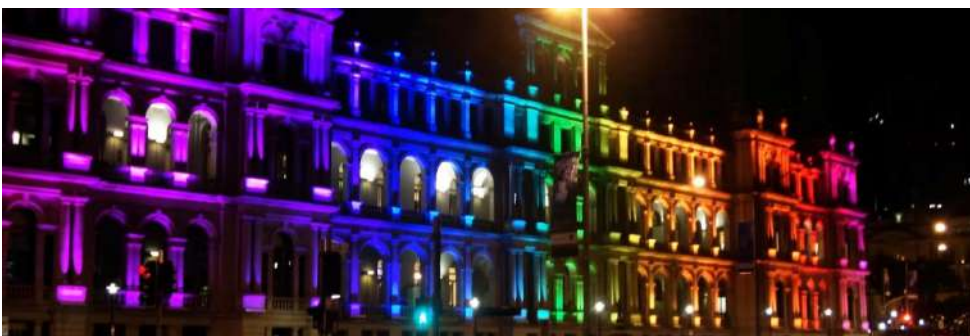



Foco LED Exterior

57-FL5-LED-20W-WH	5609651 075433
57-FL5-LED-30W-WH	5609651 075440
57-FL5-LED-50W-WH	5609651 075457
57-FL5-LED-100W-WH	5609651 075297
57-FL5-LED-150W-WH	5609651 075419
57-FL5-LED-200W-WH	5609651 075426

Descripcion

AC180-250V 50/60Hz

RA>80; PF>0.9;IP65;90grados

20W/30W/50W/100W/150W/200W

1602LM/2395LM/3360LM/7123LM/9438LM/11800LM

6000K

190x150/230x190/285x235/280x260/390x290/390x350MM

Para dónde se usa

Para naves,fachadas,campos etc.

Para substituir los proyectores de halogenuro metálico



Luminous Intensity Distribution Curve(cd/klm)

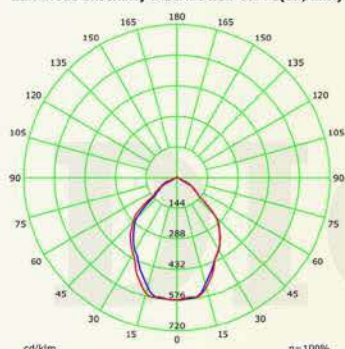

Illuminance at a Distance

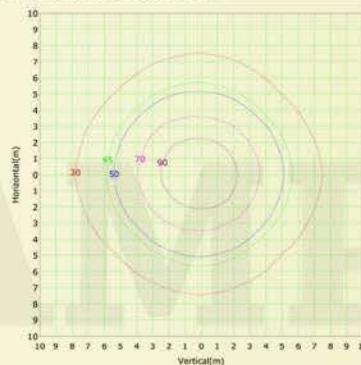
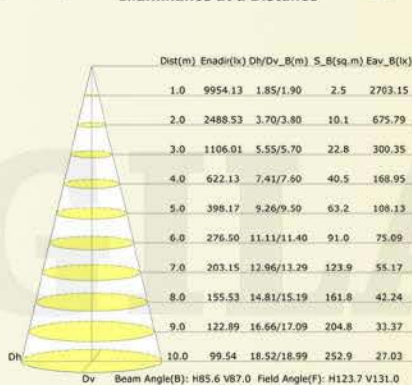



Foco Carril LED

57-LED-H40-7W-WH6K

5609651 066646

57-LED-H40-7W-BK3K

5609651 066653

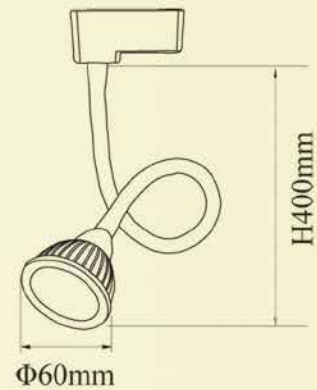

Descripcion

AC220-240V 50/60Hz

RA>80; PF>0.6;IP20;24grados

7W

600LM

6400K/3000K

60x400MM

Para dónde se usa

Para tienda de moda,ropa etc.

Para substituir los focos de carril Monofásico de halogeno

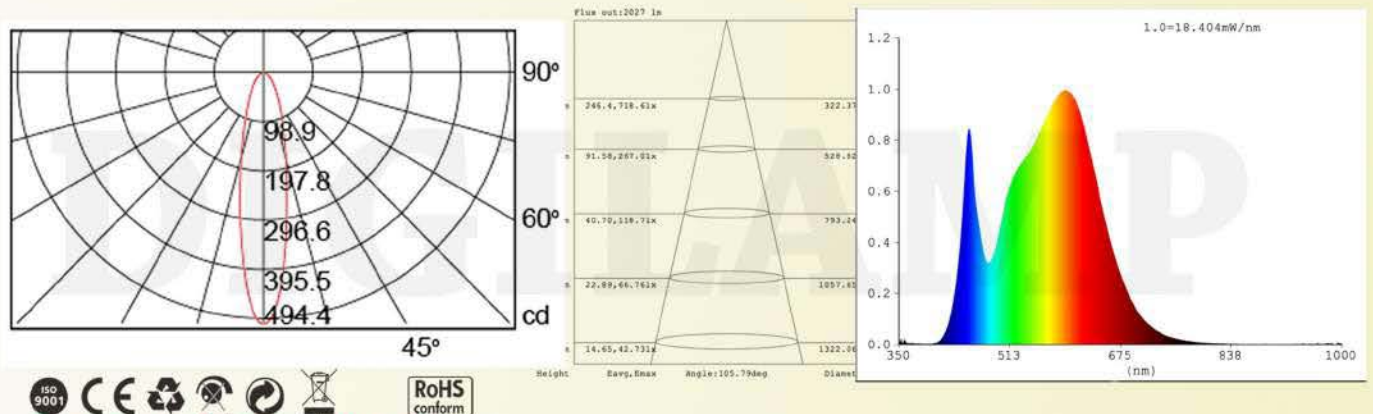



Foco Carril LED

57-D40-7W-WH4K

5609651 076485

57-D40-7W-BK4K

5609651 076478

Descripcion

AC110-240V 50/60Hz

RA>80; PF>0.6;IP20;24grados

7W

650LM

4000K

60x400MM

Para dónde se usa

Para tienda de moda,ropa etc.

Para substituir los focos de carril Monofásico de halogeno

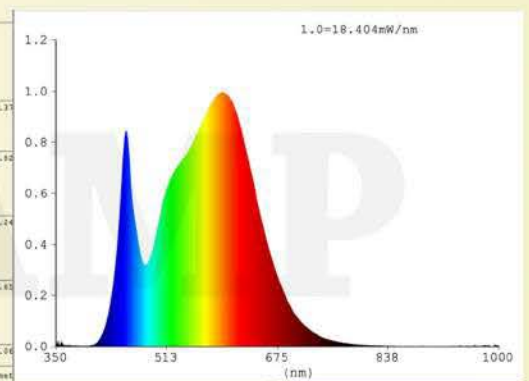
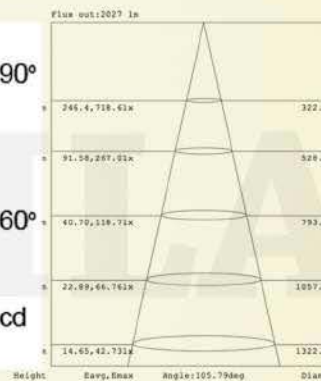
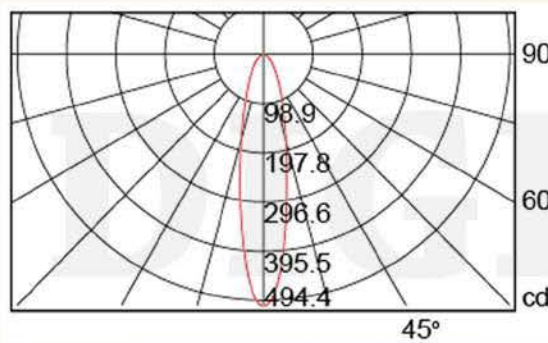



Foco Carril LED

57-D42-12W-WH4K

5609651 076539

57-D42-12W-BK4K

5609651 076522



Descripcion

AC110-265V 50/60Hz

RA>80; PF>0.6;IP20;24grados

12W

1000LM

4000K

70x350MM

Para dónde se usa

Para tienda de moda,ropa etc.

Para substituir los focos de carril Monofásico de halogeno

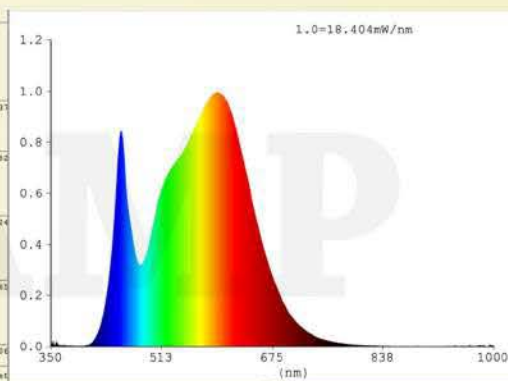
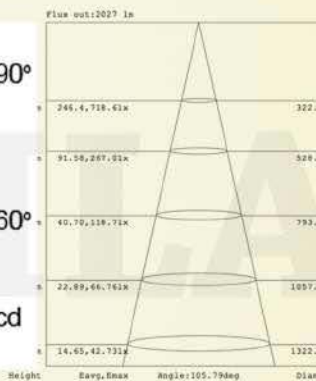
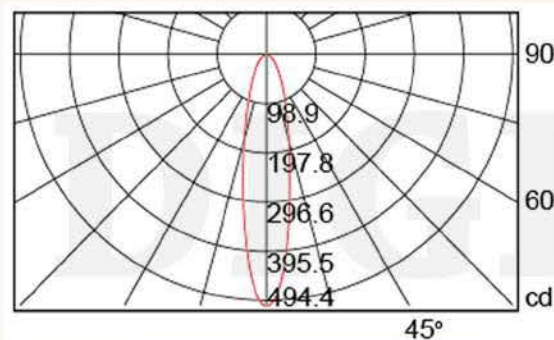



Foco Carril LED

57-LED-H223-18W-WH4K

5609651 066127

57-LED-H223-18W-BK4K

5609651

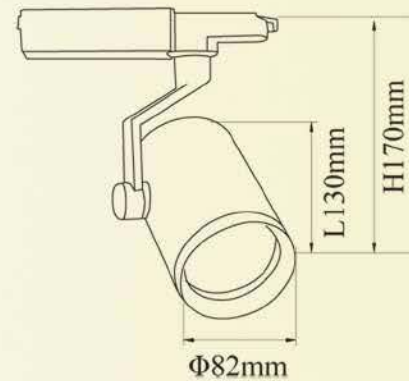

Descripcion

AC220-240V 50/60Hz

RA>80; PF>0.6;IP20;24grados

18W

1600LM

4000K

82x130x170MM

Para dónde se usa

Para tienda de moda,ropa etc.

Para substituir los focos de carril Monofásico de halogeno

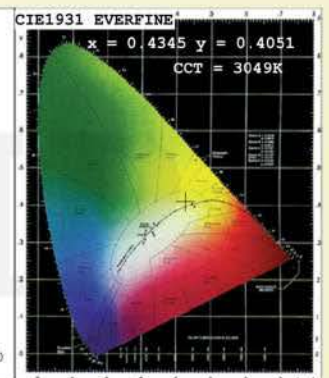
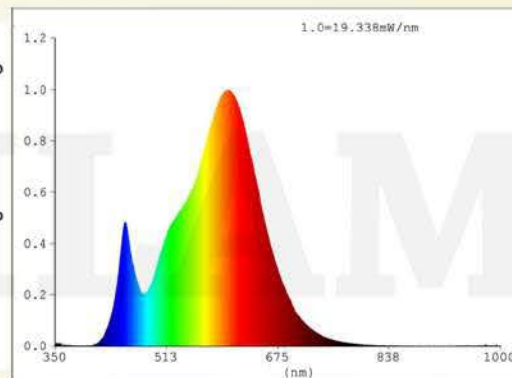
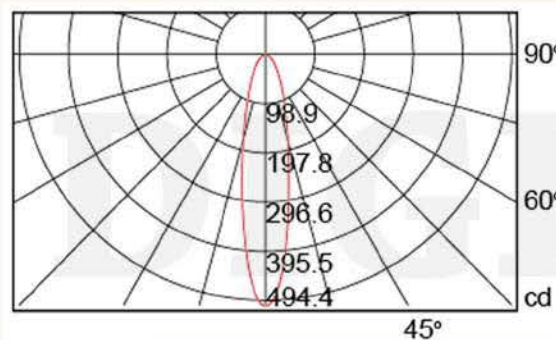



Foco Carril LED

57-LED-H229-30W-WH	5609651 063485
57-LED-H229-30W-WW	5609651 063492
57-H228-2X30W-WH3K	5609651 072302
57-H228-2X30W-BK3K	

Descripcion

AC220-240V 50/60Hz

RA>80; PF>0.6;IP20;24grados

30W

2700LM

6400K/3000K

105x145x200MM

Para dónde se usa

Para tienda de moda,ropa etc.

Para substituir los focos de carril Monofásico de halogeno

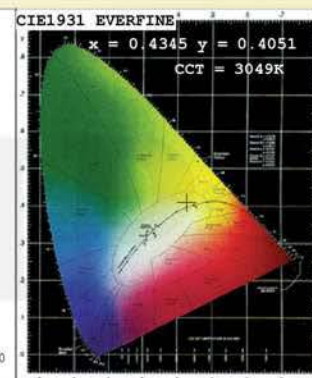
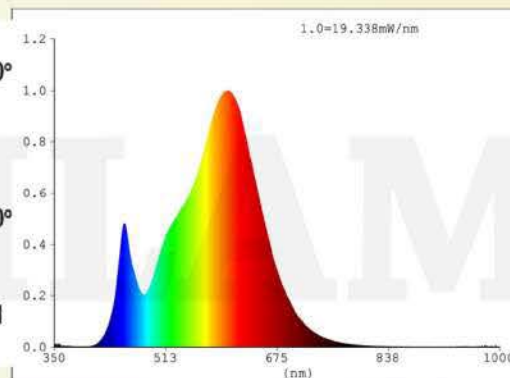
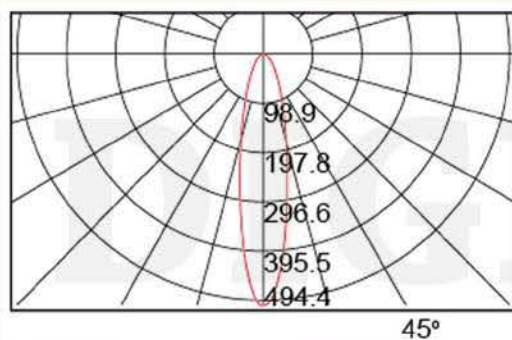
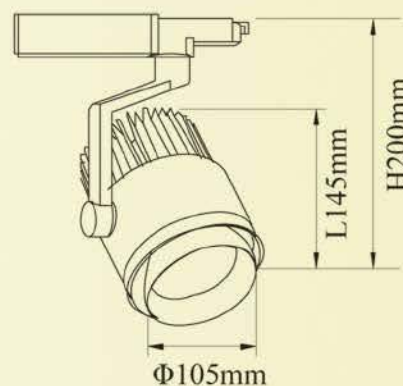



Foco Carril LED

57-LED-H228-50W-WH6K

57-LED-H228-50W-WH4K

57-LED-H228-50W-WH3K

57-LED-H228-50W-BK3K

Descripcion

AC220-240V 50/60Hz

RA>80; PF>0.9;IP20;24grados

50W

4592LM

4000K/3000K

105x145x165MM

Para dónde se usa

Para tienda de moda,ropa etc.

Para substituir los focos de carril Monofásico de halogeno

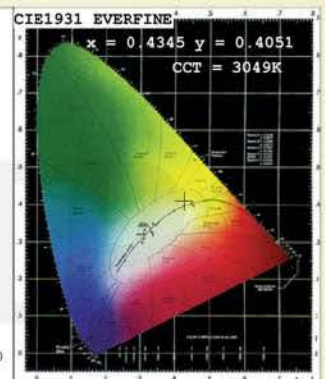
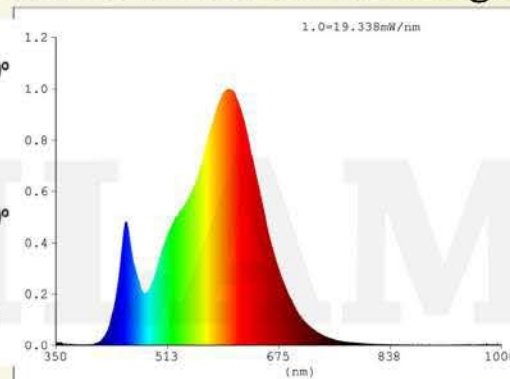
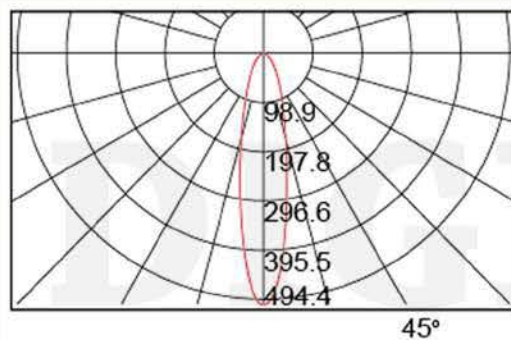
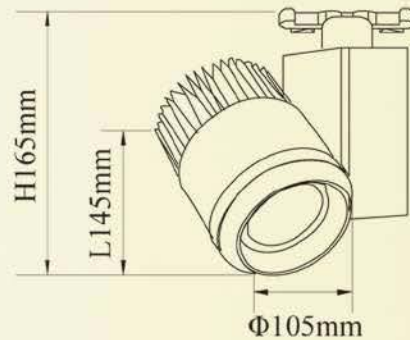



Foco Carril LED MonoFasico

57-H201-2F-50W-WH4K

5609651 075877

Descripcion

AC220-240V 50/60Hz

RA>80; PF>0.9;IP20;24grados

50W

4592LM

4000K

121x122MM

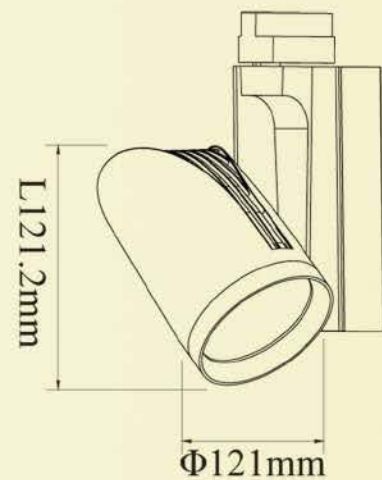

Para dónde se usa

Para tienda de moda,ropa etc.

Para substituir los focos de carril Monofásico de halogeno

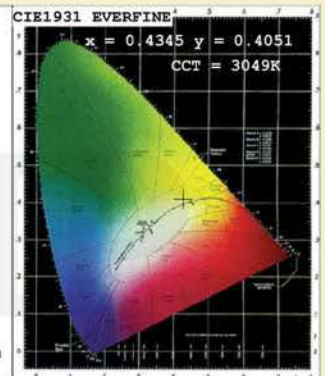
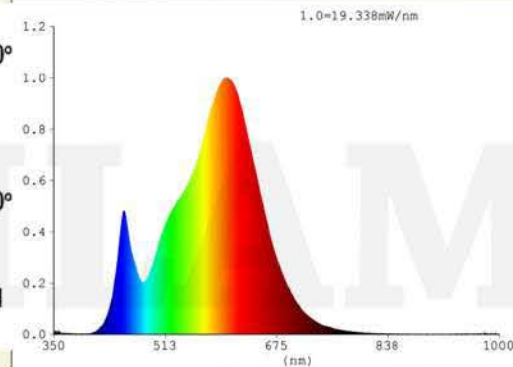
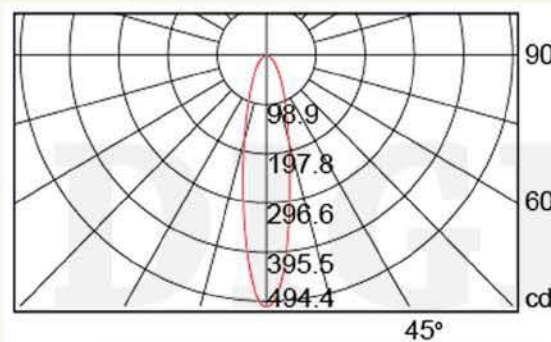



Foco Carril LED TriFasico

57-H201-4F-50W-WH4K

5609651 075273

Descripcion

AC220-240V 50/60Hz

RA>80; PF>0.9;IP20;24grados

50W

4592LM

4000K

121x122MM

Para dónde se usa

Para tienda de moda,ropa etc.

Para substituir los focos de carril Trifásico de halogeno

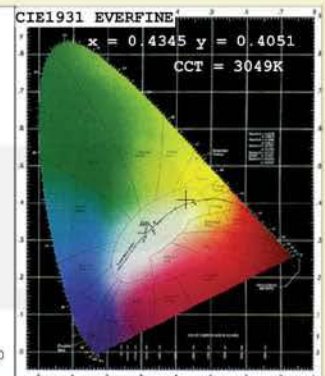
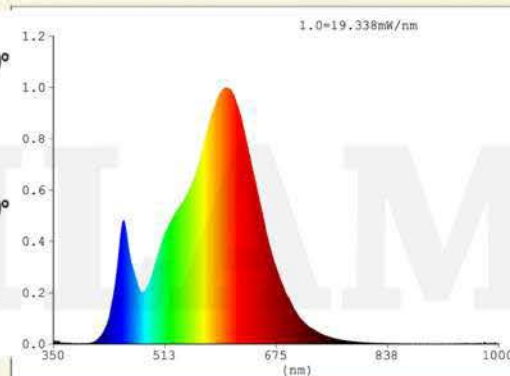
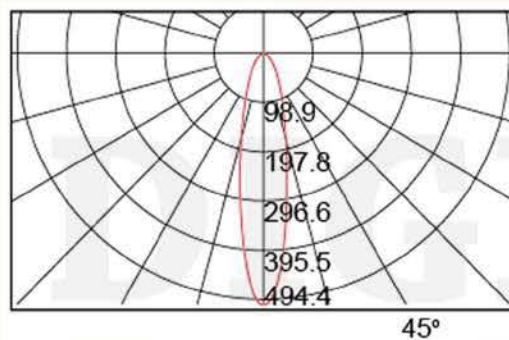
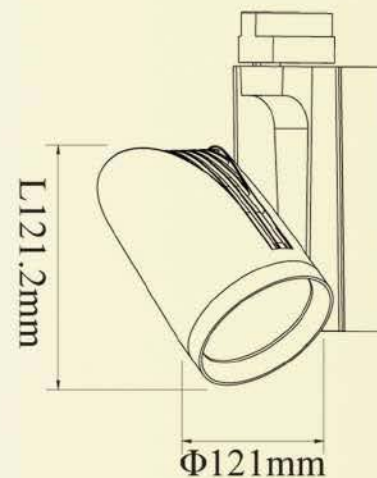



Foco Carril LED TriFasico

57-H4206-4F-35W-BK3K

5609651 070759

Descripcion

AC220-240V 50/60Hz

RA>80; PF>0.6;IP20;24grados

35W

2600LM

3000K

101x117MM

Para dónde se usa

Para tienda de moda,ropa etc.

Para substituir los focos de carril Monofásico de halogeno

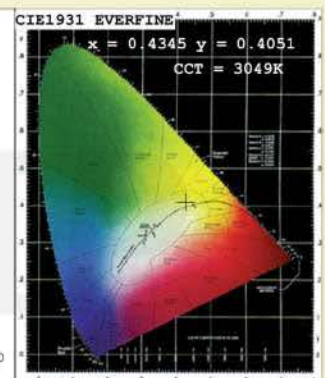
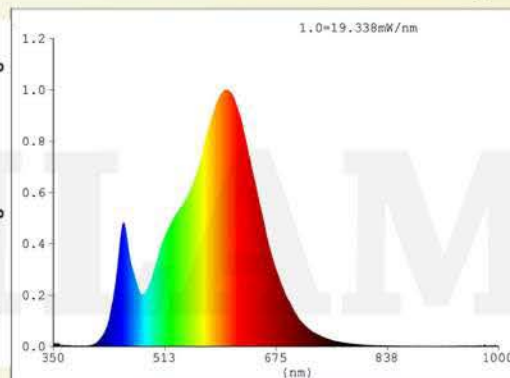
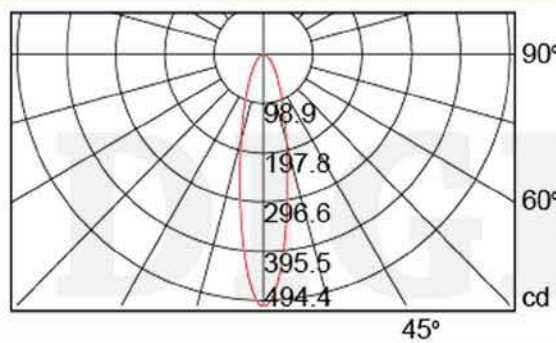



Foco Carril PAR30

57-LED-H681-PAR30-WH

57-LED-H682-PAR30-WH

Descripcion

Par30

E27

60x400MM

Para dónde se usa

Para tienda de moda,ropa etc.

Para poner las bombillas de PAR30





Tira LED 12V

55-LED5050-60-12V-WH

55-LED5050-60-12V-YE

55-LED5050-60-12V-BL

55-LED5050-60-12V-GR

55-LED5050-60-12V-RED

Descripcion

DC12V IP20/IP65

RA>80;120°

14.4W

850LM

6400K/3000K/Azul/Verde/Rojo

10MM x 5M/10M

Para dónde se usa

Para el uso de Decoración de Falso Techo, Armáριο, Mueble etc.

Para substituir Regleta de Fluorescente

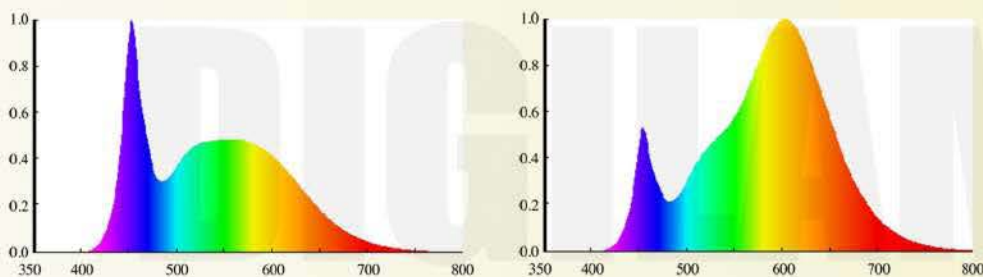

Tira LED 12V

55-LED2835S-60-12V-6K

5609651 076461



Descripcion

DC12V IP20

RA>80;120°

12W/M

500LM/M

6000K

10MM x 5M

Para dónde se usa

Para el uso de Decoración de Falso Techo, Armáριο, Mueble etc.

Para substituir Regleta de Fluorescente

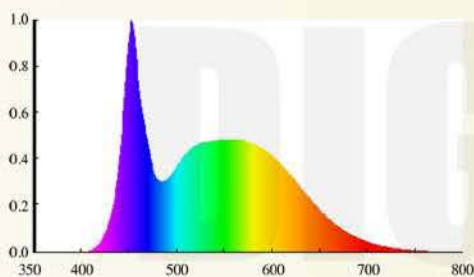

Tira LED 230V

55-LED3014-120-230V-WH

55-LED3014-120-230V-YE

55-LED3014-120-230V-BL



Descripcion

AC220-240V IP67

RA>80;120°

12W

1200LM

6400K/3000K/Azul

8MM x 50M

Para dónde se usa

Para el uso de Decoración de Falso Techo, Armáριο, Mueble etc.

Para substituir Regleta de Fluorescente

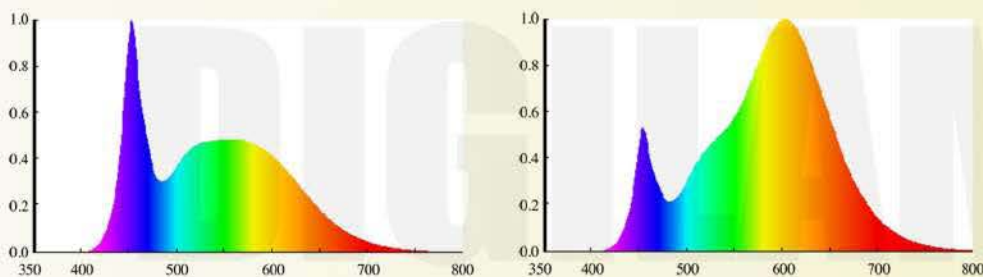



Tira Rigida LED 12V

- 55-ALU5050-60-1M-6K-IP20 5609651 076416
- 55-ALU5050-60-1M-3K-IP20 5609651 076423
- 55-ALU5050-60-1M-RGB-IP20 5609651 076430
- 55-ALU5730-60-1M-6K-IP20 5609651 076454
- 55-ALU5730-60-1M-3K-IP20 5609651 076447

Descripcion

DC12V IP20

RA>80;120°

10W/12W

600LM/800LM

6800K/2800K/RGB

10MM x 1M

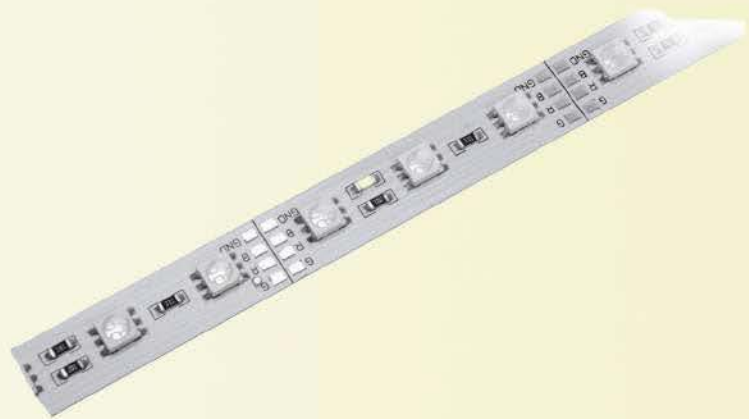

Para dónde se usa

Para el uso de Decoración de Falso Techo, Armáριο, Mueble etc.

Para substituir Regleta de Fluorescente

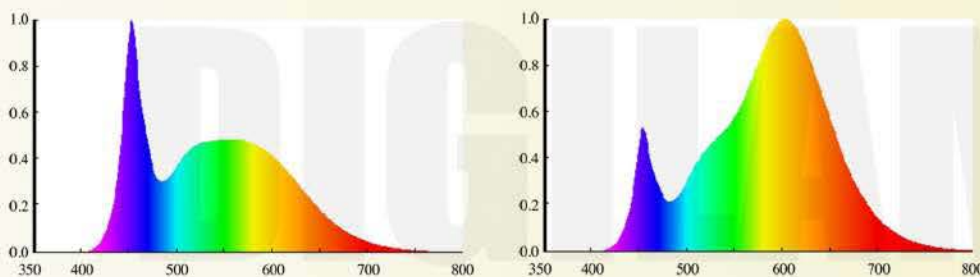



Perfil Aluminio para Tira

57-SW1506-1M-F	5609651	065984
57-SW1506-2M-F	5609651	065977
57-SW2507-1M-F	5609651	066004
57-SW2507-2M-F	5609651	065991
57-SW003-1M-F	5609651	066035

Descripcion

Perfil de Aluminio Para Tira de 10MM

Difusor Opal

Superficie 15MMx6MM

Empotrar 25MMx7MM

Triangulo 12MMx12MM

1 Metro/2 Metros

Para dónde se usa

Para el uso de Decoración de Falso Techo, Armáριο, Mueble etc.

Para usar junto con Tira LED Flexible o Rigido

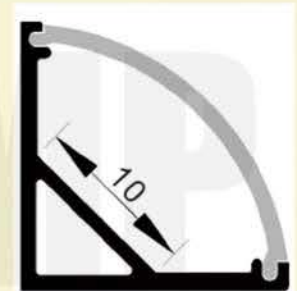
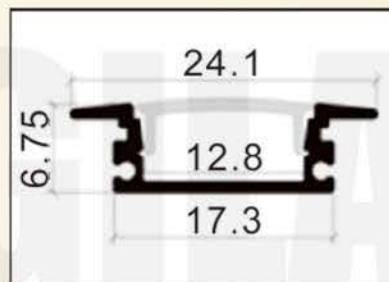
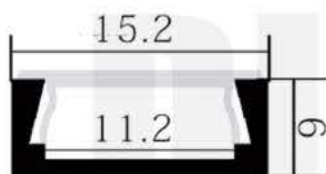



LED Neon 230V

55-NEON-MINI-RED	5609651 068572
55-NEON-MINI-OR	5609651 068565
55-NEON-MINI-BL	5609651 068589
55-NEON-MINI-GR	5609651 068558
55-NEON-MINI-PUR	5609651 068534
55-NEON-MINI-PI	5609651 068541
55-NEON-MINI-WH	5609651 068596
55-NEON-MINI-WW	5609651 068848
55-NEON-MINI-YE	5609651 068510

Descripcion

AC220-240V 50/60Hz IP67

LED2835 ;120°

5W/Metro 80LEDs/Metro

80LM/W

6400K/3000K/2000K/Azul/Rojo/Verde/Naranja/Rosa/Purpura

8MM x 50M

Para dónde se usa

Para el uso de Decoración de Falso Techo, Publicidad, Mueble etc.

Para substituir Neon Normal

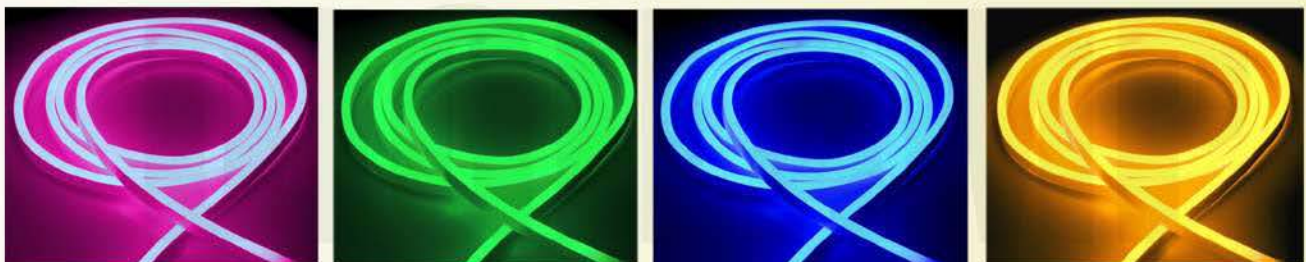



Regleta T5 con Interruptor

50-T5K-600-8W-NW	5609651 075488
50-T5K-900-10W-WH	5609651 075501
50-T5K-900-10W-NW	5609651 075495
50-T5K-900-10W-YE	5609651 075518
50-T5K-1200-14W-NW	5609651 075525

Descripcion

AC220-240V 50/60Hz IP20

RA>80; PF>0.6

8W/10W/14W

640LM/800LM/1120LM

6400K / 4000K/3000K

583/873/1173 X 22 X 32MM

Para dónde se usa

Para el uso de Espejo de Baño, Armario, Muebles etc.

Para substituir regleta antigua de Fluorescente

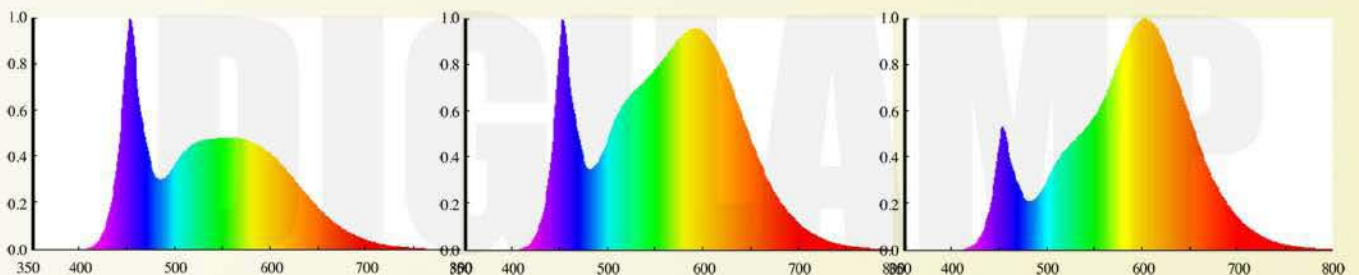

Pantalla LED



62-LED-TE18W-WH 5609651 069005

62-LED-TE36W-WH 5609651 069012

Descripcion

AC100-240V 50/60Hz

RA>80; PF>0.9

18W/36W

1600LM/3180LM

6400K

600X75X25MM / 1200X75X25MM

Para dónde se usa

Pantalla LED Ideal para cocina,Alta Calidad

Luz blanca,120 grados de gran angulo

Flux out:12.53 lm		36W	
3.281 ft	75.78,81.15fc	0.4551 ft	
1m	815.6,873.5lx	13.87 cm	
6.562 ft	18.94,20.29fc	0.9102 ft	
2m	203.9,218.4lx	27.74 cm	
9.843 ft	8.420,9.016fc	1.365 ft	
3m	90.63,97.05lx	41.61 cm	
13.12 ft	4.736,5.072fc	1.82 ft	
4m	50.98,54.59lx	55.49 cm	
16.4 ft	3.031,3.246fc	2.275 ft	
5m	32.63,44.94lx	69.36 cm	
Height	Eavg,Emax	Angle:7.93deg	Diameter

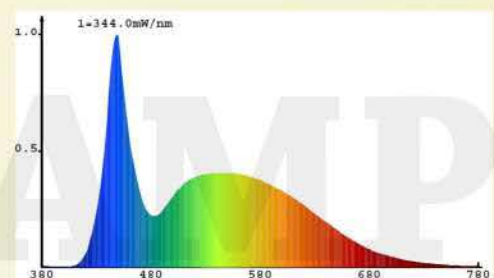
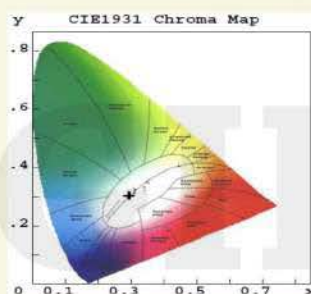

NOVEDADES

Regleta LED extraplana



62-LED-TE18W-WH
62-LED-TE36W-WH
62-LED-TE45W-WH

62-LED-TE18W-WW
62-LED-TE36W-WW

Descripción:

AC100-240V 50-60Hz

RA> 80 PF>0.9 IP20 160º Grados de apertura

18W -> 600x75x25 mm

36W -> 1200x75x25 mm

45W -> 1500x75x25 mm

85Lm/W

6.400K (WH) y 3.200K (WW)

Para donde se usa:

Decoración, cocinas, oficinas, ...

Sustituye a dos tubos de fluorescente de 2x18W o 2x36W o 2x45W

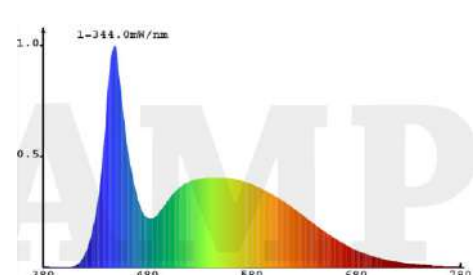
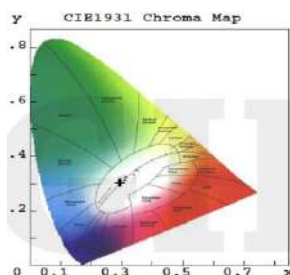
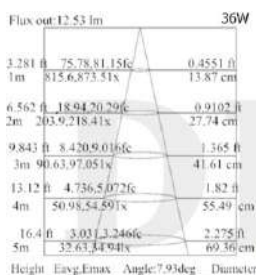



Regleta Colgante LED

62-PND-36W-6K

5609651 076317

Descripcion

AC220-240V 50/60Hz

RA>80; PF>0.9;IP20;120grados

36W

3600LM

6500K

1200x68x65MM

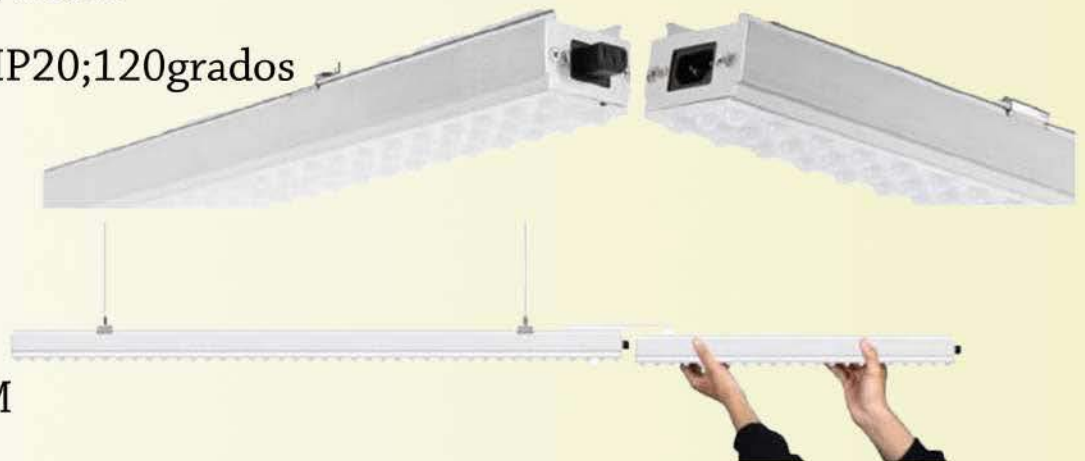

Para dónde se usa

Para Colegio,Oficina,Centro Comercial etc.

Para substituir las regletas colgantes con tubo fluorescente normal

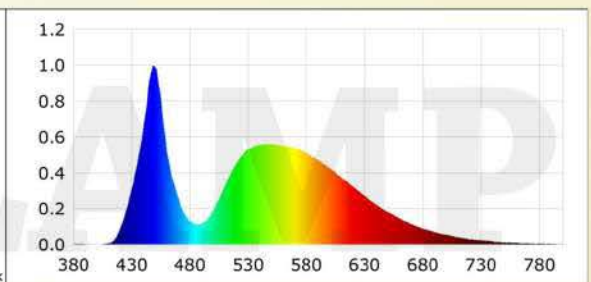
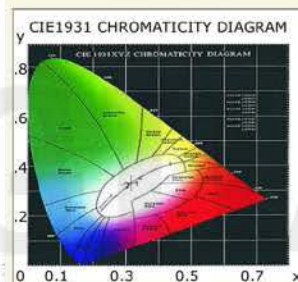
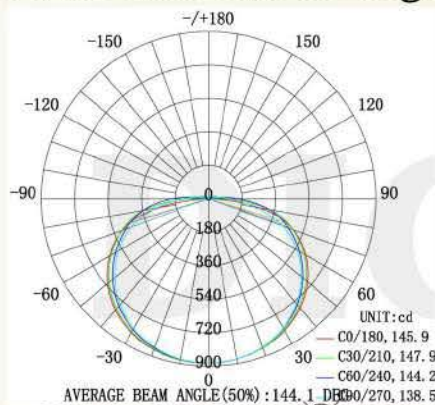



Pantalla Estanca LED

62-0S600-20W-WH	5609651 073262
62-0S1200-40W-WH	5609651 073279
62-0S1500-60W-WH	5609651 073286

Descripcion

AC220-277V 50/60Hz

RA>80; PF>0.9;IP65;120grados

20W/40W/60W

1800LM/3600LM/5000LM

6400K

600MM/1200MM/1500MM

Para dónde se usa

Para Nave, Garaje, Tunel etc.

Para substituir las pantallas con tubo fluorescente normal

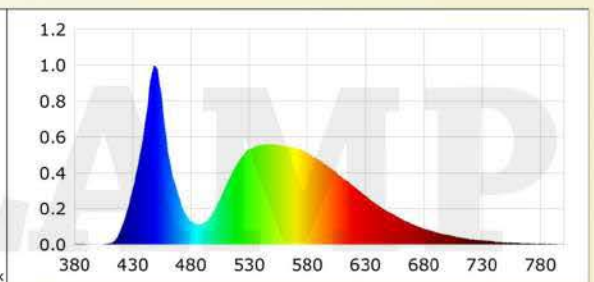
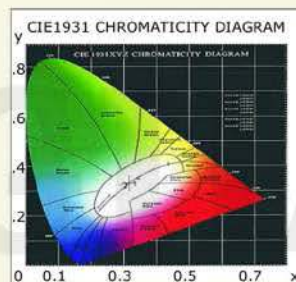
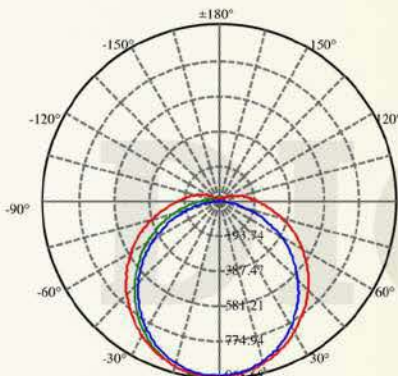
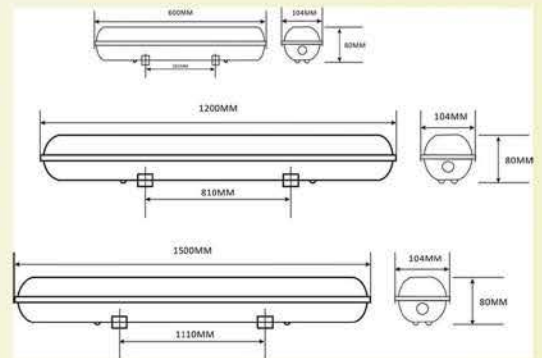



Pantalla Estanca Vacía

62-0118PC-1	5609651 073255
62-0218PC-1	5609651 073149
62-0136PC-1	5609651 073248
62-0236PC-1	5609651 073231
62-0158PC-1	5609651 073224
62-0258PC-1	5609651 073217

Descripcion

Base de ABS Acrilonitrilo Butadieno Estireno

Pantalla de PC Policarbonato

Altura 94MM

Anchura 85MM /135MM

Larga 660MM / 1268MM / 1562MM

Conexión de 1 Lado

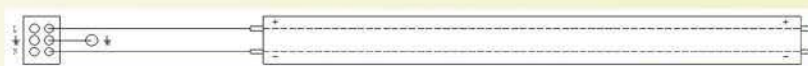

Para dónde se usa

Para Nave, Garaje, Tunel etc.

Para substituir las pantallas con tubo fluorescente normal





Pantalla Estanca Vacia

62-0118PC-2	5609651 073200
62-0218PC-2	5609651 073194
62-0136PC-2	5609651 073187
62-0236PC-2	5609651 073170
62-0158PC-2	5609651 073163
62-0258PC-2	5609651 073156

Descripcion

Base de ABS Acrilonitrilo Butadieno Estireno

Pantalla de PC Policarbonato

Altura 94MM

Anchura 85MM /135MM

Larga 660MM / 1268MM / 1562MM

Conexión de 2 Lados



Para dónde se usa

Para Nave, Garaje, Tunel etc.

Para substituir las pantallas con tubo fluorescente normal



Aplique Ovalado LED



- 68-BL-OV-8W-WH4K 5609651 074702
- 68-BL-OV-12W-BK3K 5609651 074719
- 68-BL-OV-12W-WH4K-SENS 5609651 074726

Descripcion

AC220-240V 50/60Hz

RA>80; PF>0.6;IP54

8W/12W

550LM/850LM

4000K/3000K

200x100x55MM/230x105x55MM

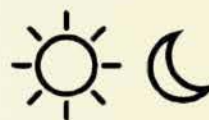

Para dónde se usa

Para Porches de comunidad de vecino,de chalet

Para substituir ojos de buey normal con bombilla de bajo consumo

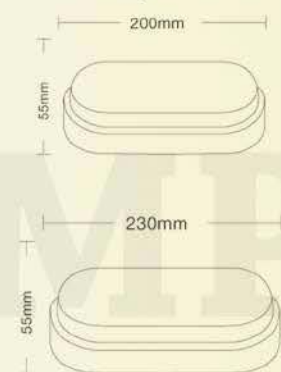
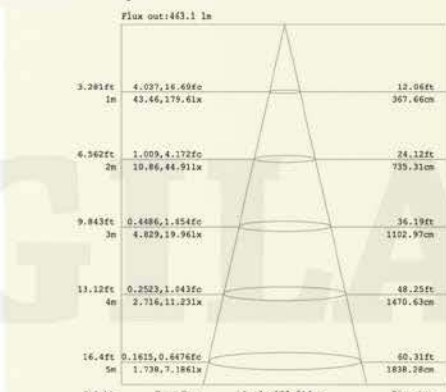
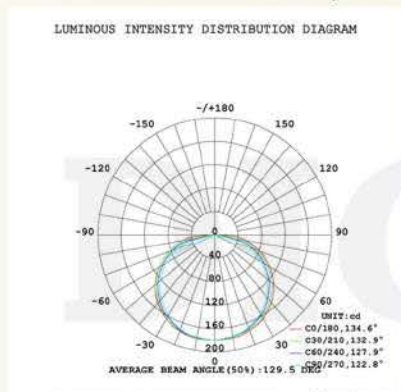

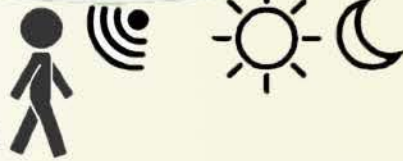

Plafon LED

68-CL3R-12W-WH4K	5609651 074733
68-CL3Q-12W-WH4K	5609651 074757
68-CL3R-18W-WH3K	5609651 074740
68-CL3Q-18W-WH3K	5609651 074764
68-CL3R-12W-WH4K-SENS	5609651 074771

Descripcion

AC220-240V 50/60Hz

RA>80; PF>0.6;IP44

12W/18W

800LM/1200LM

4000K/3000K

220x220x53MM/280x280x53MM

Para dónde se usa

Para Porches de comunidad de vecino,de chalet

Para substituir Plafon normal con bombilla de bajo consumo

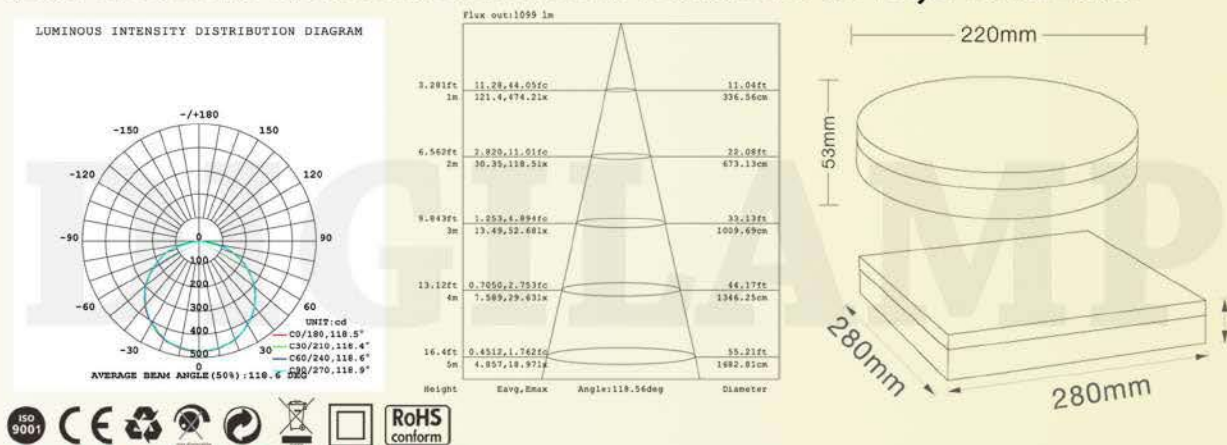

LED Exterior



68-CL20RA-8W-BK6K	5609651 076089
68-CL20RA-8W-BK4K	5609651 076096
68-CL20RA-8W-WH6K	5609651 076102
68-CL20RA-8W-WH4K	5609651 076119

Descripcion

AC220-240V 50/60Hz

RA>80; PF>0.5;IP54;120grados

8W

640LM

6400K/4000K

178x80MM

Para dónde se usa

Para Porches de comunidad de vecino,de chalet

Para substituir Plafon normal con bombilla de bajo consumo

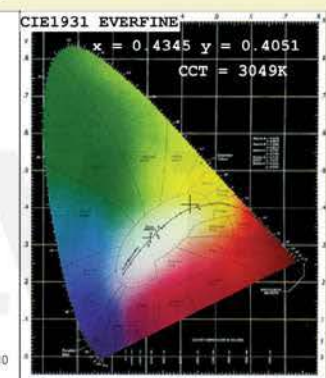
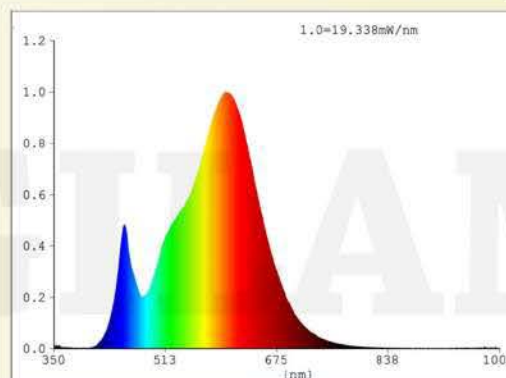
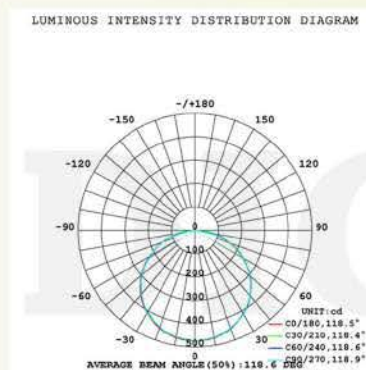

LED Exterior

62-LED-015-A-12W-NW 5609651 070599



Descripcion

AC85-265V 50/60Hz

RA>80; PF>0.9;IP65

12W

1020LM

4000K

275x86MM

Para dónde se usa

Para Porches de comunidad de vecino,de chalet

Para substituir Plafon normal con bombilla de bajo consumo

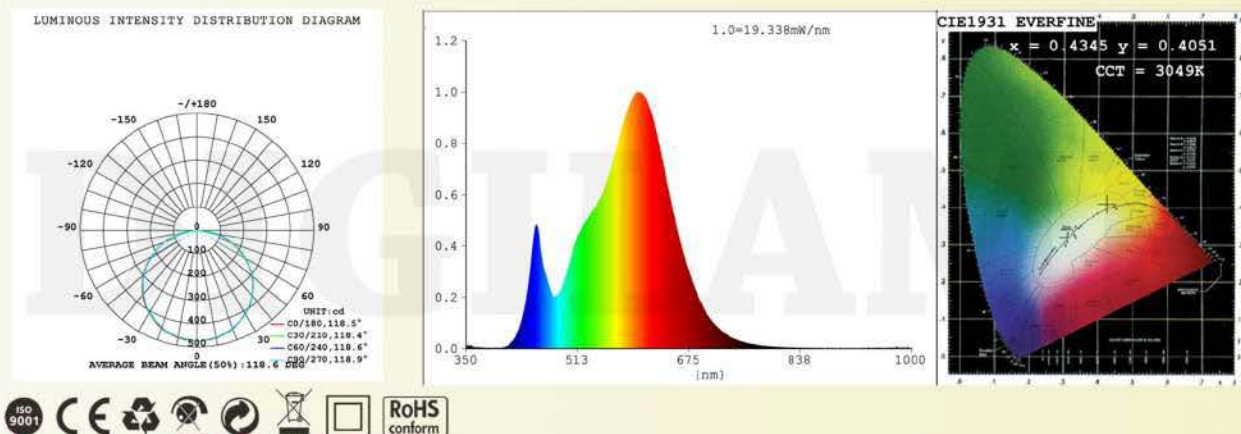

LED Exterior

62-LED-015-C-12W-NW 5609651 070568



Descripcion

AC85-265V 50/60Hz

RA>80; PF>0.9;IP65

12W

1020LM

4000K

275x86MM

Para dónde se usa

Para Porches de comunidad de vecino,de chalet

Para substituir Plafon normal con bombilla de bajo consumo

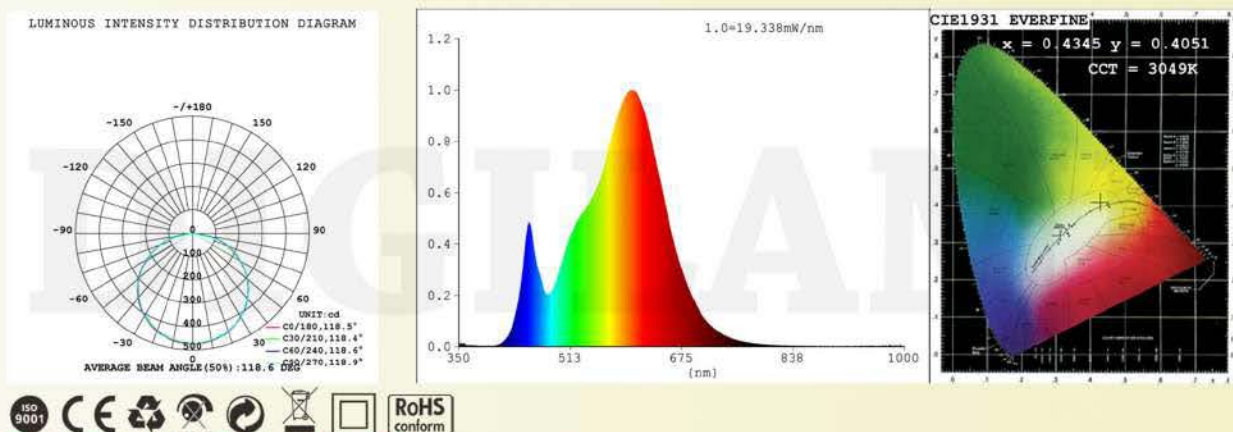

LED Exterior

62-LED-018-B-6W-NW 5609651 070513



Descripcion

AC85-265V 50/60Hz

RA>80; PF>0.9;IP65

6W

510LM

4000K

220x135x80MM

Para dónde se usa

Para Porches de comunidad de vecino,de chalet

Para substituir Plafon normal con bombilla de bajo consumo

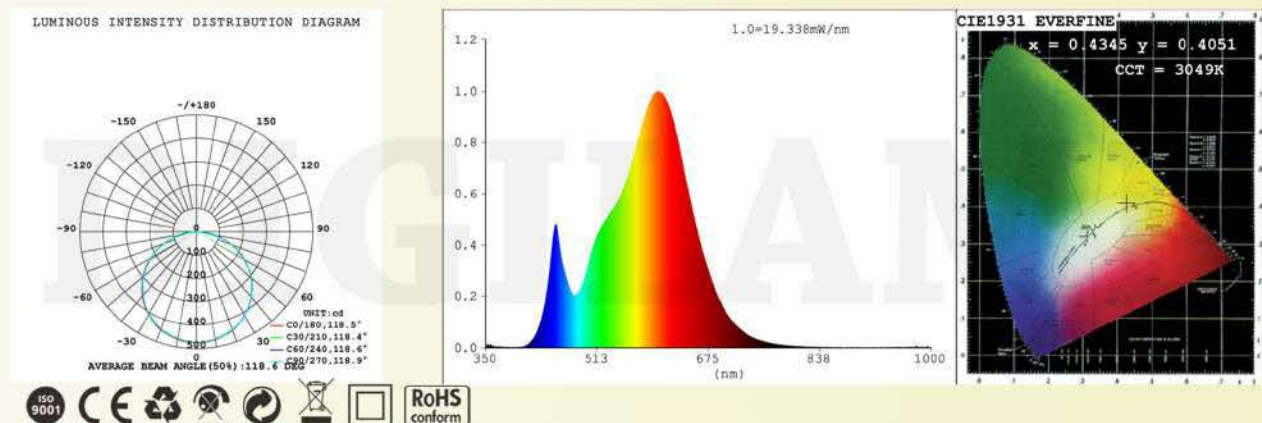



LED Tubo Aluminio

50-LED-T8-1-Superior

Descripcion

AC100-240V 50/60Hz

RA>80; PF>0.95;160°

9W/18W/24W

140LM/W Conexión 1 Lado

6000K/5000K/4000K/3000K

Φ=28MM.H=600MM/1200MM/1500MM

Para dónde se usa

Para cualquier Pantalla que lleva Tubo T8

Para substituir los Tubos T8 de Fluorescente normal

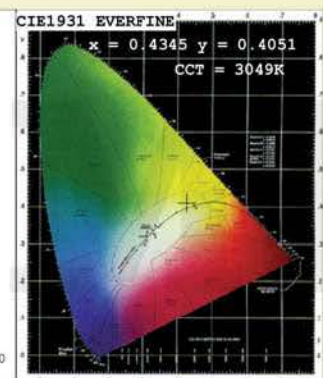
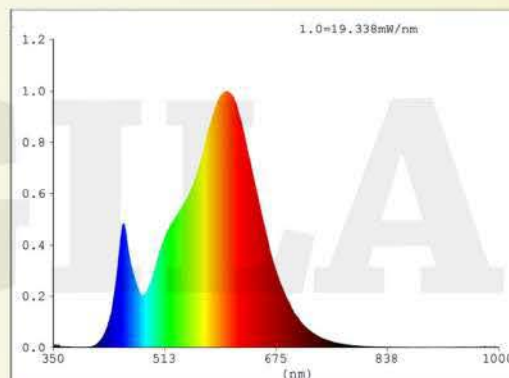
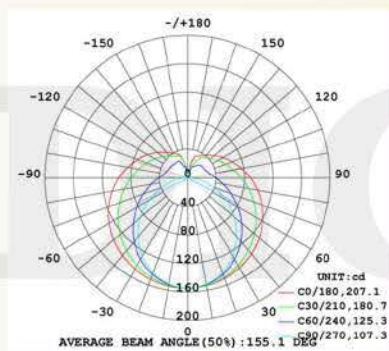



Downlight LED SMD

57-LED-2935-30W-WH

57-LED-2935-40W-WH

57-LED-2935-50W-WH

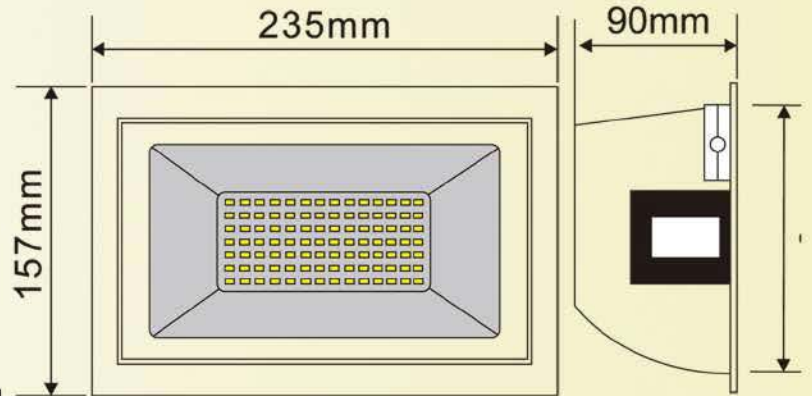

Descripcion

AC110-265V 50/60Hz

RA>80; PF>0.9;IP20;120grados

30W/40W/50W

2600/3800/4200LM

4000K/3000K

235x157x90MM

Para dónde se usa

Para Hotel,tienda,concesionario etc.

Para substituir los downlights de halogeno o bajo consumo

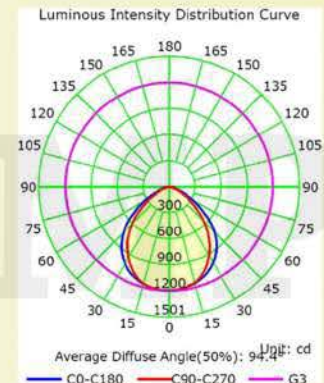
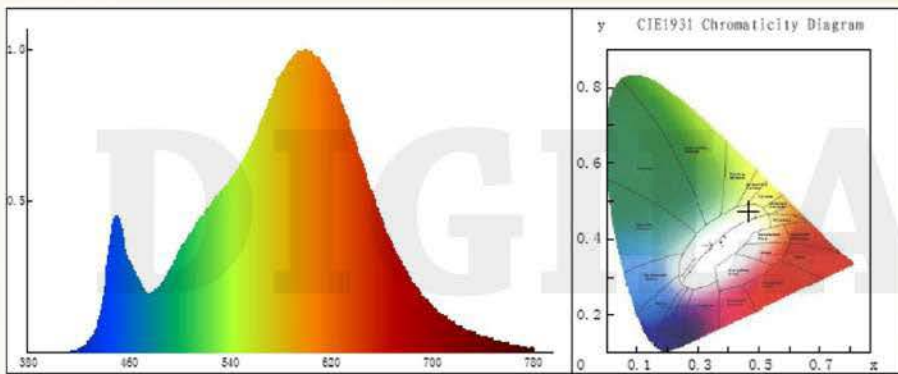



Panel Extraplano

57-LED-PLF6060-UGR

Descripcion

AC160-260V 50/60Hz IP20

RA>80; PF>0.95; UGR17

36W 115LM/W

Dimable

6000K / 4000K/3000K

595 x 595MM.H=13MM.

Para dónde se usa

Para el uso de Techo Astro de Oficina, Colegio, etc.

Para substituir las luminalias de fluorescente.

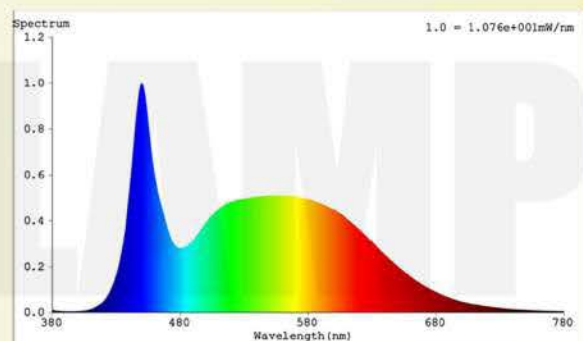
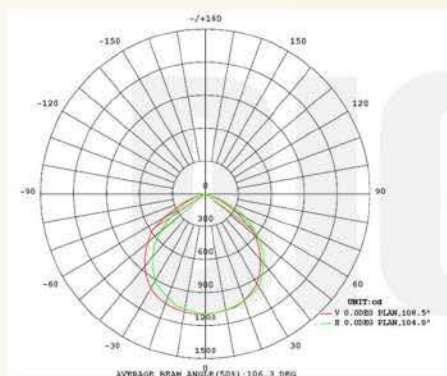

Foco LED Exterior

57-LED-GT518-120W



Descripcion

AC220-240V, 50/60Hz

RA>80; PF>0.9;IP65

120W

90LM/W

5700K

430x500x98MM

Para dónde se usa

Para uso de techo de gasolinera

Para substituir los proyectores de halogenuro metálico

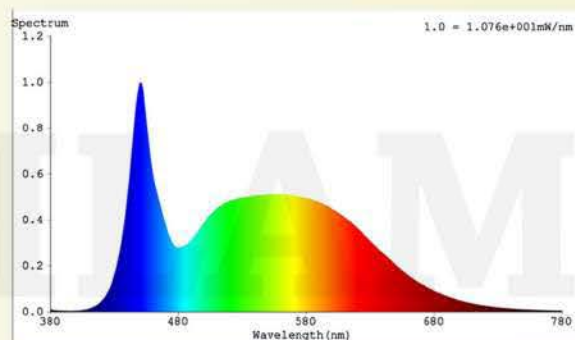
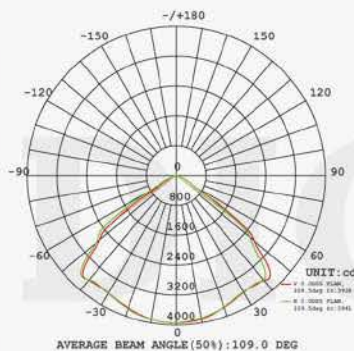



Foco LED Exterior

- 57-LED-T300-50W
- 57-LED-T300-100W
- 57-LED-T300-150W
- 57-LED-T300-200W
- 57-LED-T300-300W

Descripcion

AC90-277V,DC24V 50/60Hz

RA>80; PF>0.9;IP65

50W/100W/150W/200W/300W

120LM/W

2700K-6500K. Philips+MeanWell

242x102/242x221/242x340/419x221/425x340MM

Para dónde se usa

Para naves,fachadas,campos etc.

Para substituir los proyectores de halogenuro metálico

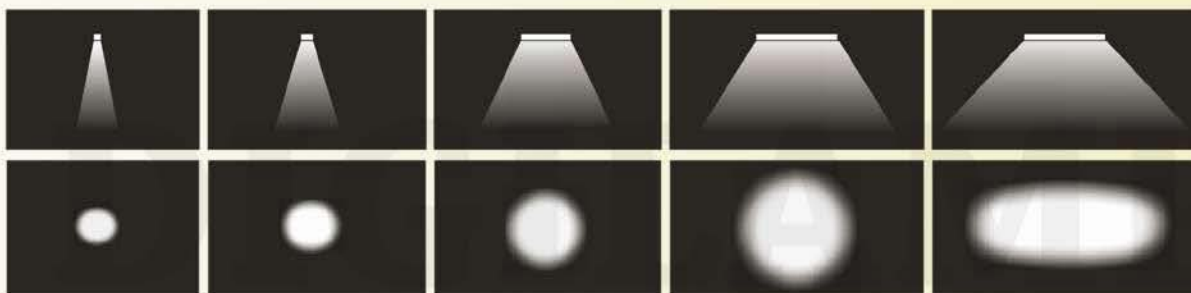

15°

30°

60°

110°

135° × 65°



RoHS conform



Foco LED Exterior

57-LED-L300-50W

57-LED-L300-100W

57-LED-L300-150W

57-LED-L300-200W

57-LED-L300-240W

Descripcion

AC90-277V,DC24V 50/60Hz

RA>80; PF>0.9;IP66

50W/100W/150W/200W/240W

120LM/W

2700K-6500K. Philips+MeanWell

81x271x438/548/658/768/878MM

Para dónde se usa

Para via publica,parking,parque, etc.

Para substituir los proyectores de halogenuro metálico

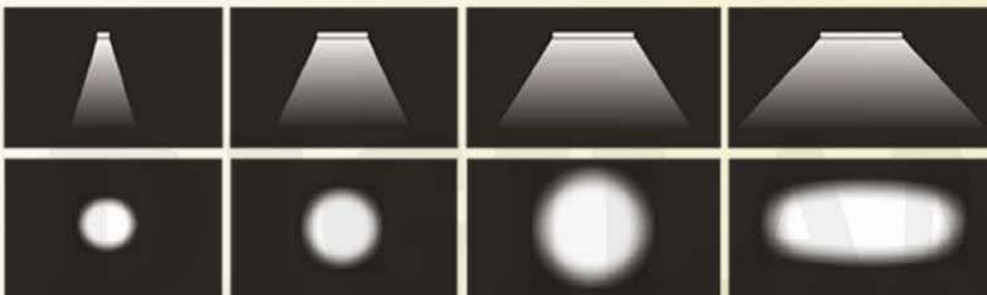

30°

60°

110°

135° × 65°



NOVEDADES



Lámparas decorativas

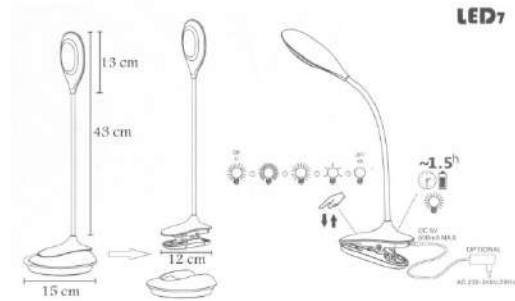

Descripción:

64-LED-T006J

609651 076744

Lámpara de mesa en color blanco de **4.5W 120LM** en luz natural/día (**4000K**) perfecto para leer, estudiar o trabajar.

Encendido **táctil** con **tres posiciones de intensidad** y con brazo flexible.

Batería con **autonomía de 90 minutos**, dependiendo de la intensidad de luz en su uso, o bien directo a 220V mediante conector USB.

El **soporte** viene **adaptado** tanto para el uso de **pinza** como de **sobremesa**.

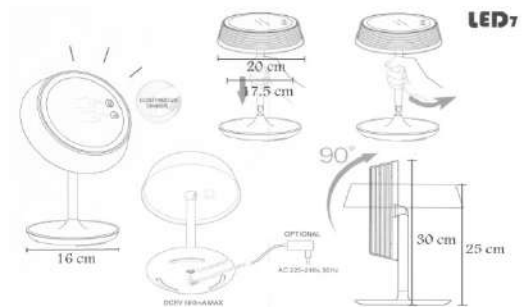

64-LED-T806

609651 076751

Descripción:

Sobremesa de color blanco **con espejo con LED integrada** de **3.5W 35-80LM** en luz blanco/frío (**6000K**) en la zona del espejo y luz cálida (**3200K**) en la zona de la base.

Encendido **táctil y dimable** tanto en la zona del espejo como en el de base.

El espejo tiene una **rotación de 90°** para su perfecta colocación.

Batería con autonomía de 90 minutos, dependiendo de la intensidad de luz en su uso, o bien directo a 220V mediante conector USB.

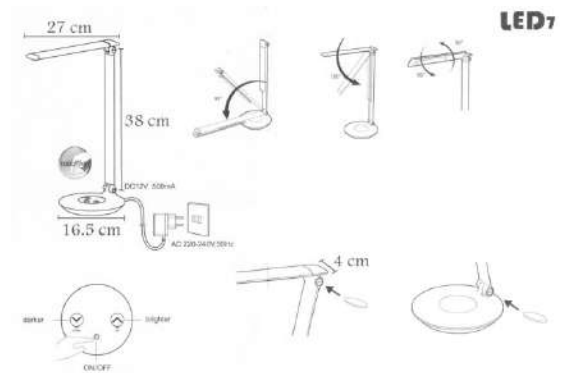

64-LED-T807

5609651 076768

Descripción:

Lámpara de mesa en color blanco de **6W** y **300LM** en luz natural/día (**4000K**) perfecto para leer, estudiar o trabajar.

Encendido **táctil** con **varias intensidades de luz** y **brazo de dos cuerpos** totalmente **orientables**.

Conectado directo a **220V** con su respectivo **enchufe**.

Medida: 165 x 650 mm