

# Es pa ña

Inspired, designed  
and made in Spain

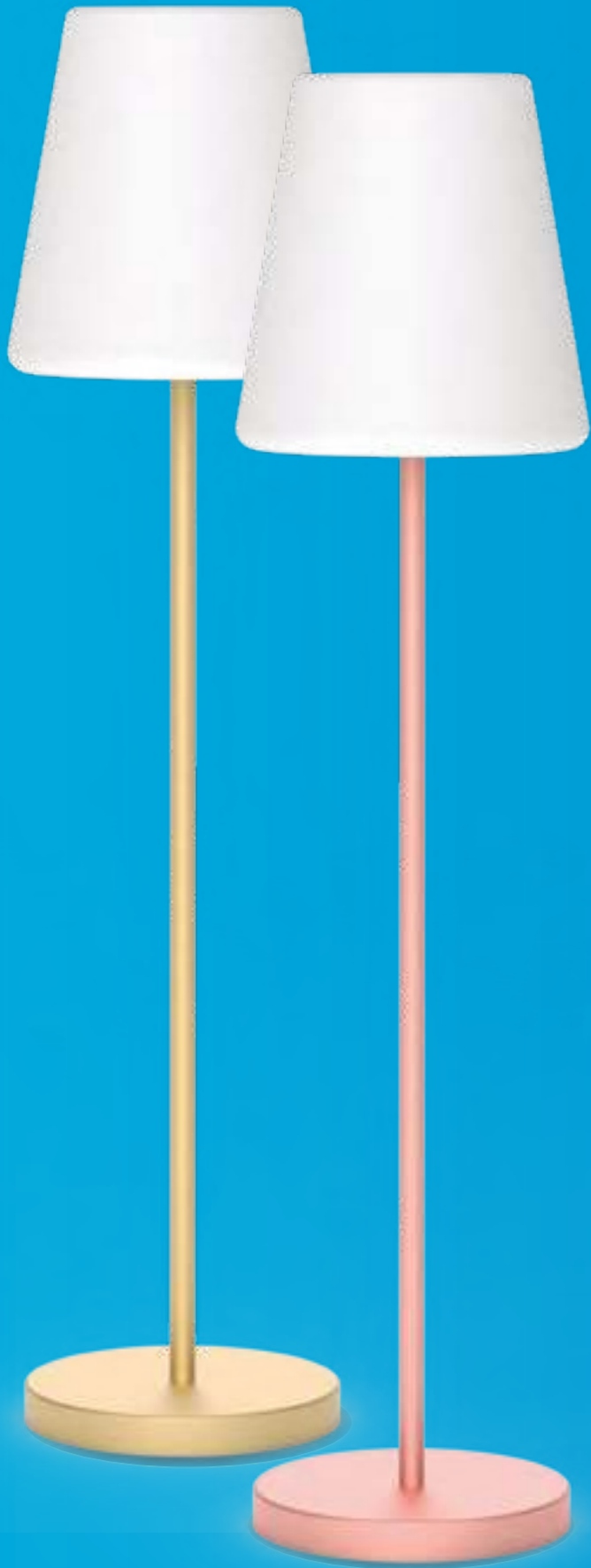

new  
garden  
be happy

Newgarden emerged by the sea, lying on the beach, where the sun and waves were the protagonists, transmitting peace and happiness. A feeling that will fill any space and connect it with the most pleasant part of the day.

Light, colour, design and sound - a different way of seeing life with a Mediterranean touch.



be  
ha  
ppy



## Newgarden Studio

The design is something complex, unique and unrepeatable, arising from an idea with a touch of heart. At Newgarden we create our designs until they become a member of our family. Each and every one of our products receives the greatest attention from our designers and engineers, making them ahead of their time, innovative and, above all, original.



*Valerio Fumella*

Born in Tuscany, Valerio has always been closely influenced by the Mediterranean, and that is reflected in each of his designs. He has proven to be one of the most innovative international designers.

At Newgarden we have had the pleasure of collaborating with him to create unique and original products with a Mediterranean touch.



**achodoso®**

Difference is clearly Achodoso's key to success. Two young product design students, creating innovative and, above all, simple products. That's why at Newgarden we are delighted to have collaborated with them designing Helga.

*we are Newgarden,  
your design partner*



LOLA SLIM 120/180	16
CHLOE PLANT	18
CHLOE 140	22
ROCKET 70/145	24
FITY 100/160	26
HELGA	28
PANCHO	30
LOLA 110/165/200	32
CARMEN 110/165	34
FREDO 140/170	36
KONIKA 170	38
GRACE 140/170	40
GUFO	42
SAMBA	42
KAKTUS	43
GOA	44

BALANS	44
NATURE COLLECTION	46
NORAI	48
BITA	48
SORA	48
STELLA	50
ALLEGRA	51
RUDY	52
CHLOE 35	53
ENOKI	54
LOLA SLIM 30	56
LOLA 20/30/45	58
PANCHITO	59
ROCKET 20	59
MAFALDA	60
CARMEN 45	61

CANDELA	62
NÓMADA	62
KURBY	63
FARALAY	63
ROBIN PLAY	64
CUBY PLAY	64
NIPPER	65
PIPA	65
BALBY HANG	66
BULY HANG	66
PETRA HANG	66
CLAUDY	67
PAQUITA	68
WALL	72
BULY FAMILY	74
PETRA	76
CUBY FAMILY	77

# Light & Deco



RASA	82
FORMENTERA	84
NEW ISLAND	86
SET TARIDA	88
CAPRI 75 & MALLORCA	92
ITACA & MALLORCA	93
MENORCA SOFÁ	94
MENORCA BENCH	95

CALVIN & MELVIN	96
CUBY PLAY	97
BORA	98
CUBY	100
BRICKY	101
SICILIA	104
IBIZA & CRETA	106
PALMA BOTTLE RACK	108

WOODY	109
CAPRI 110 & CORFU 74	110
BAHAMA	112
PUFY & TAFY	113
CAPRI 40 & CORFU 40	113

# Furniture



HORTENSIA 30/40/50/80	116
MAGNOLIA FAMILY	118
MELISA 30/40/50	120
FICUS 60/80	122
BAMBÚ 70/90	123
PALMERA	124

JUNCO	125
JARA	126
NARCISO 40/50/60	127
CAMELIA FAMILY	128
PALMA	130
HIEDRA	131

GERBERA	132
VIOLETA	133

# Flower pots



AMELIO	136
SNOWY 40/100	137

PINUS	138
NOVA 45/60	140

KLAUS	141
-------	-----

# Christmas

# Light & Deco

Light illuminates us in the dark and shows us the way. Being able to change our mood in just seconds. With our products we strive to make your day brighter. Fill each space with light in a variety of colours and products offered by Newgarden.

Light, technology, colour, design and endless sensations to discover.





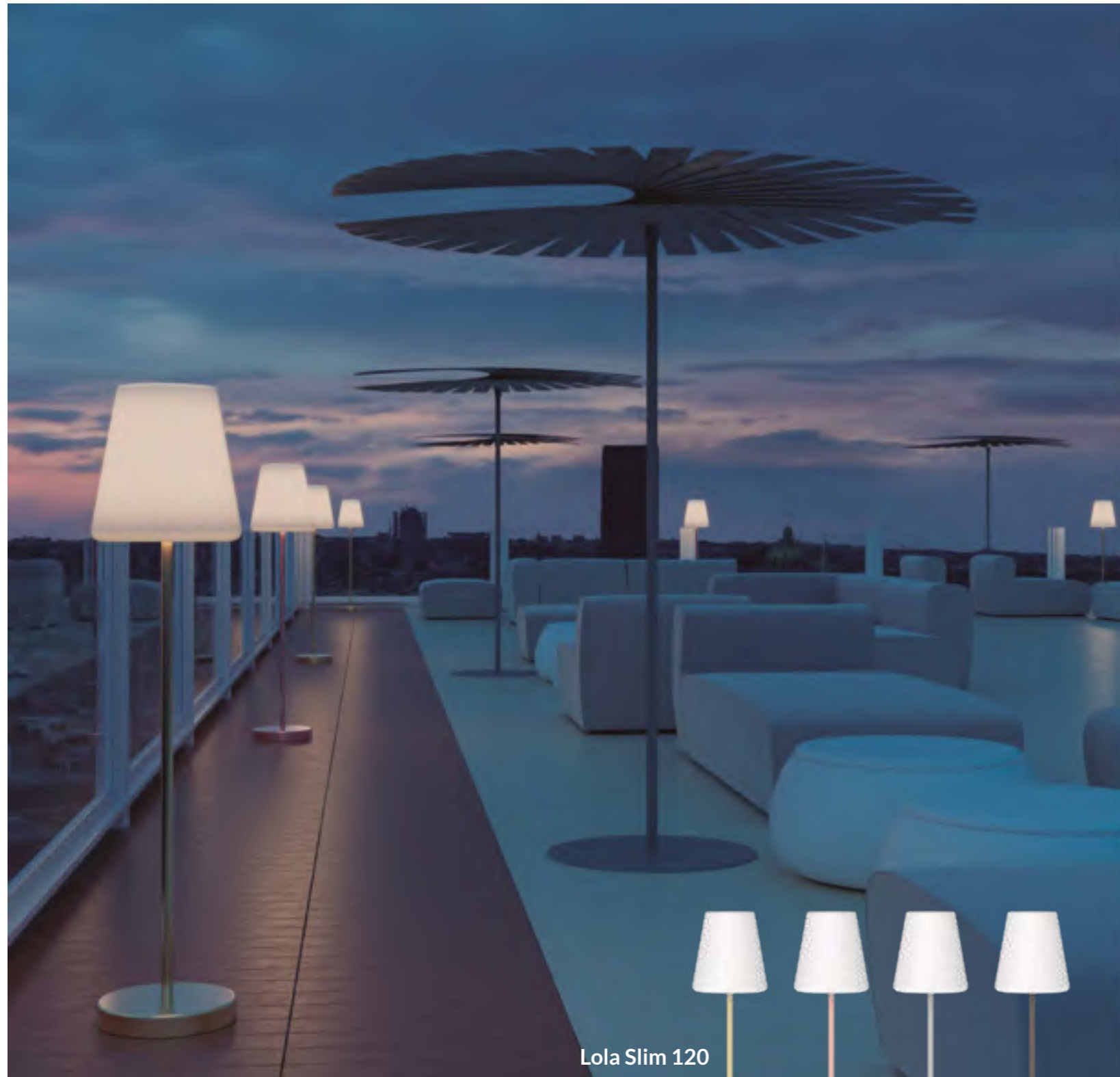

Lola Slim 120



Brass    Rose gold    Space grey    Antracite

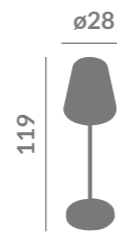

Lola Slim 120

Options  
Light

- Solar & battery
- Cable
- Solar & battery

+ Info P. 152



Lola Slim 180

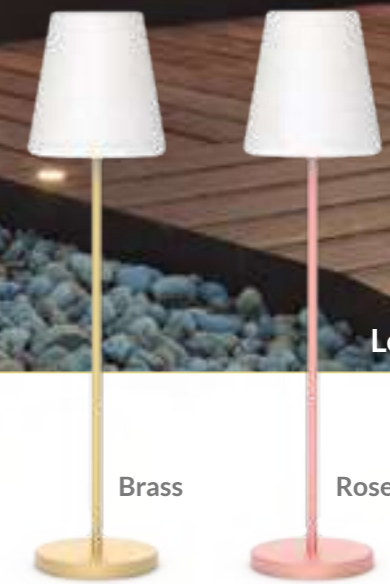

Brass    Rose gold

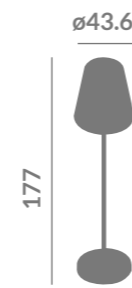

Lola Slim 180

Options  
Light

- Cable
- Solar & battery

+ Info P. 152

# Lola slim



# Chloe plant



**5 LAMPS IN 1 LAMP**

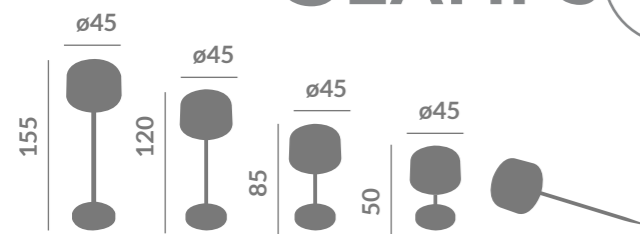

Chloe plant

Options

Light | Solar & battery

+ Info P. 152



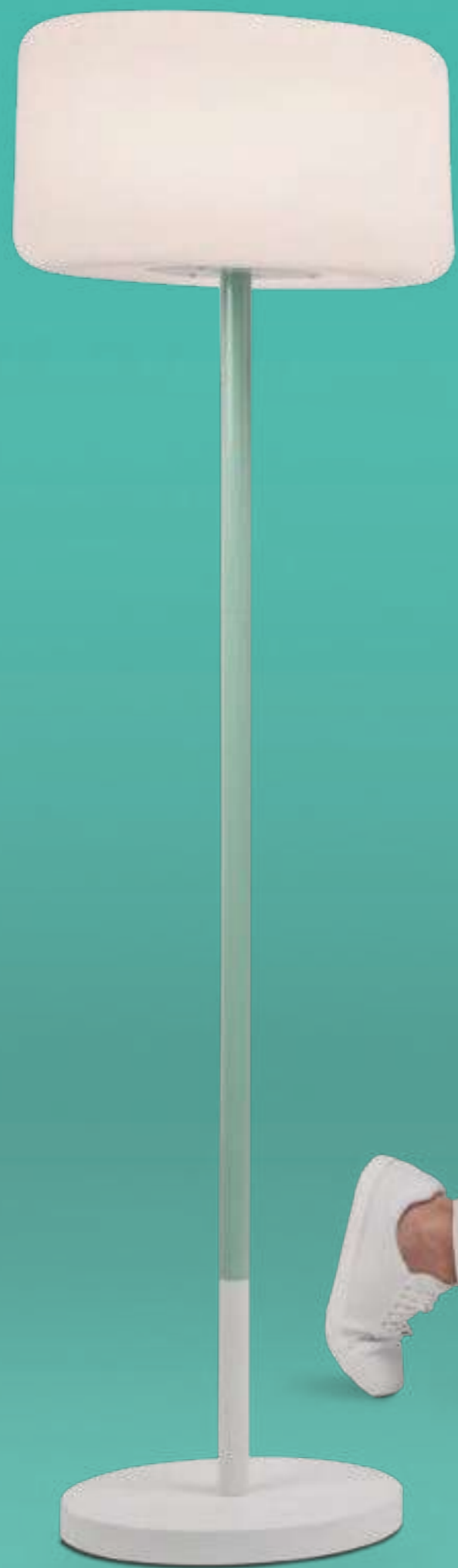

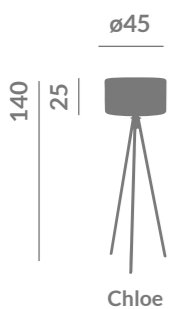

ø45

140

25



Chloe

**Options**  
**Light**



Cable



Solar & battery

+ Info P. 152



# Chloe



Rocket 70



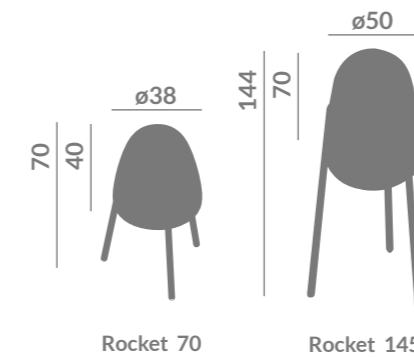

Rocket 145

# Rocket



**Options**

**Light**

-  Cable
-  Solar & battery

+ Info P. 153



# Fity

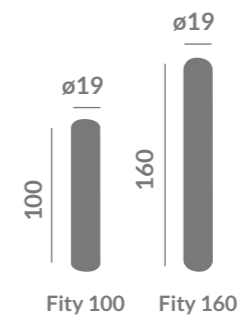

## Options

- Light |  Cable  Battery

+ Info P. 153

# Helga

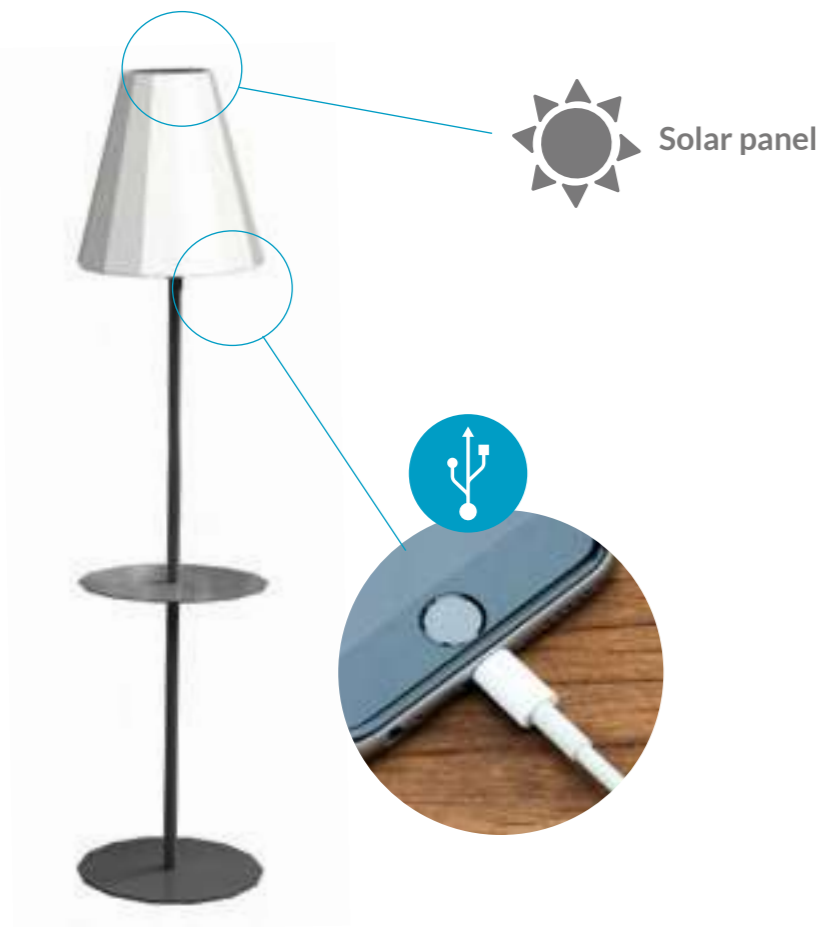

155  
60  
Helga

Options  
Light

Solar & battery

+ Info P. 154





# Pancho

Options

Light

- Cable
- Battery

+ Info P. 154

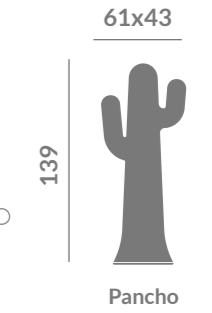





# Lola

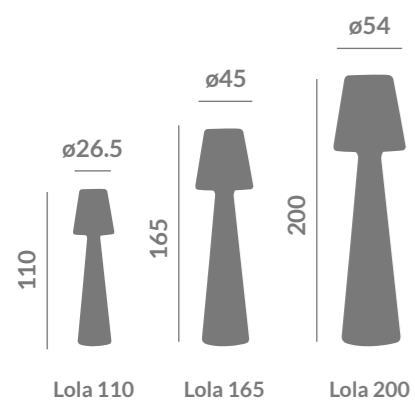

Options  
Light

-  Cable
-  Battery

+ Info P. 154, 155





# Carmen

Options

Light



Cable



Battery



+ Info P. 155

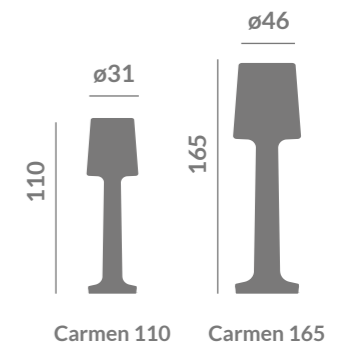



# Fredo

## Options

- Light 
- Cable 
- Battery 

+ Info P. 155

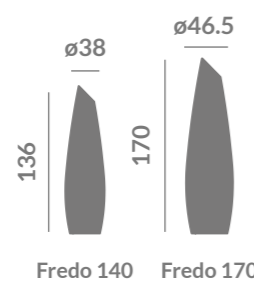



# Konika

Options

- Light
- Cable
- Battery

+ Info P. 156



# Grace



## Options

Light



Cable



Battery

+ Info P. 153, 154



Grace 140

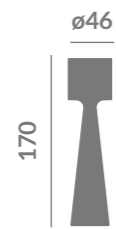

Grace 170





# Gufo

**Options**

Light

- Cable
- Solar & battery

+ Info P. 158



# Samba

**Options**

Light

- Cable
- Battery

+ Info P. 158



# Kaktus

**Options**

Light

- Cable
- Battery

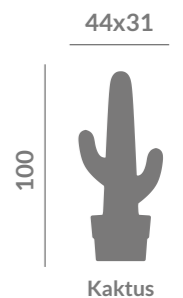

+ Info P. 158



# Goa



## Options

- Light  Cable
- Solar & battery 
- Battery 

+ Info P. 157, 158

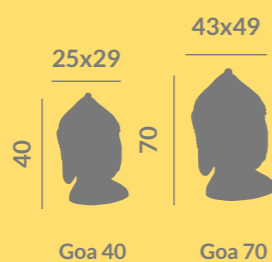

# Balans



## Options

- Light  Cable
- Battery 

+ Info P. 157

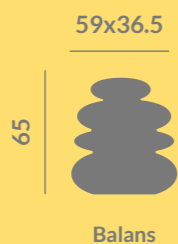

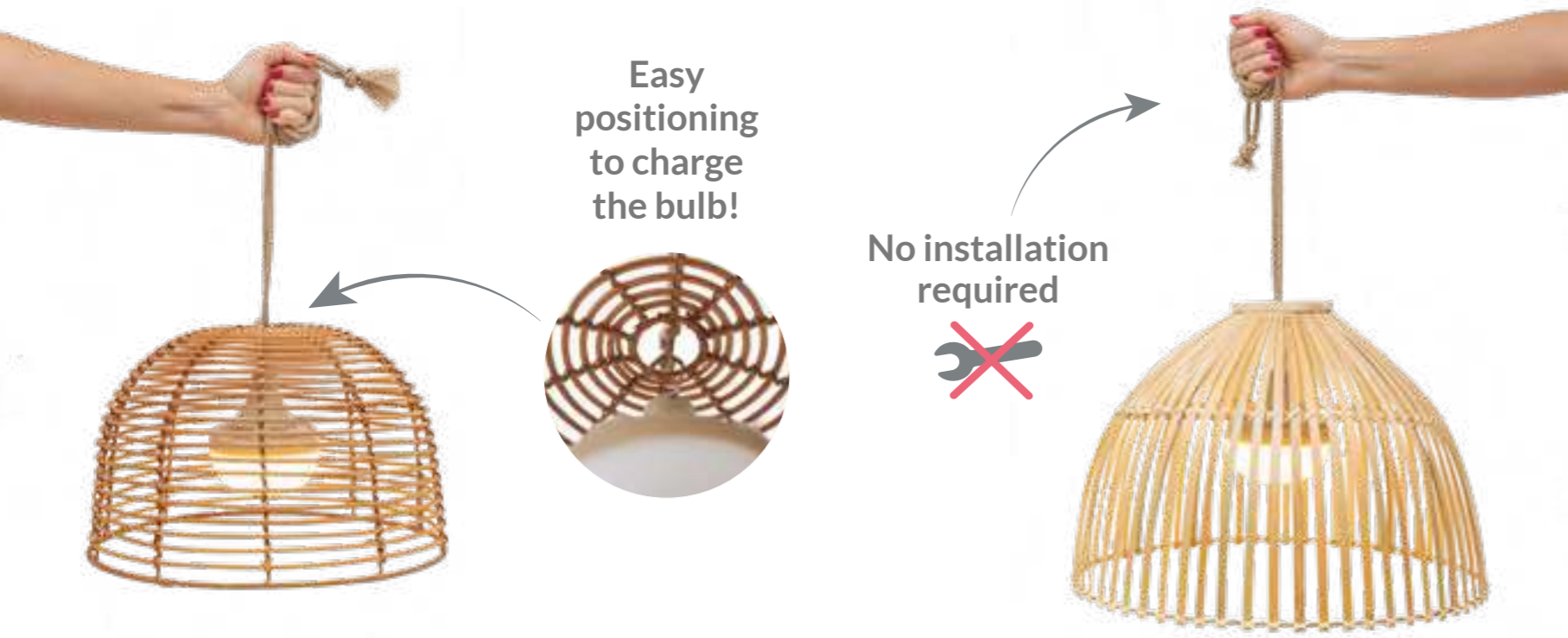

## Bossa

Options

Light |  Battery

+ Info P. 156

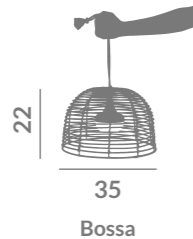

## Reona

Options

Light |  Battery

+ Info P. 156

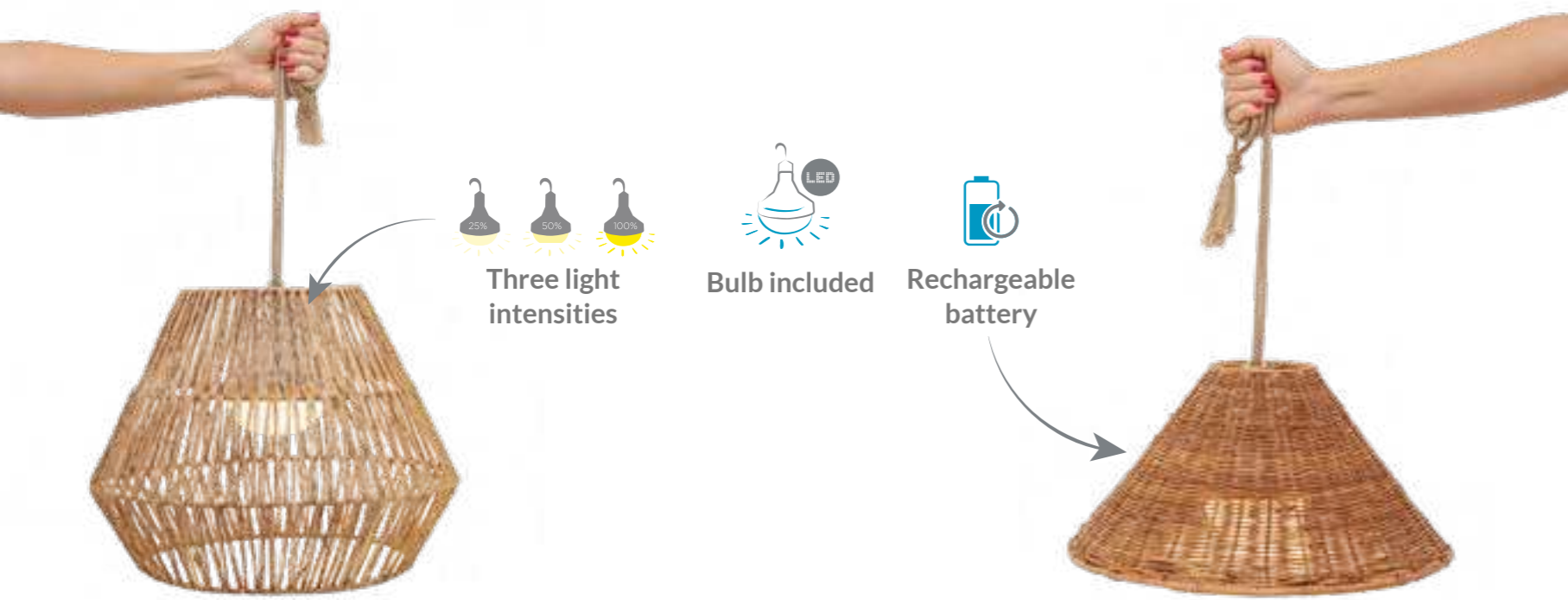

## Sisine

Options

Light |  Battery

+ Info P. 156

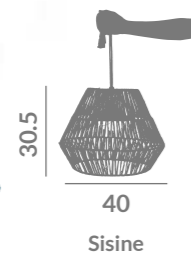

## Calobra

Options

Light |  Battery

+ Info P. 156

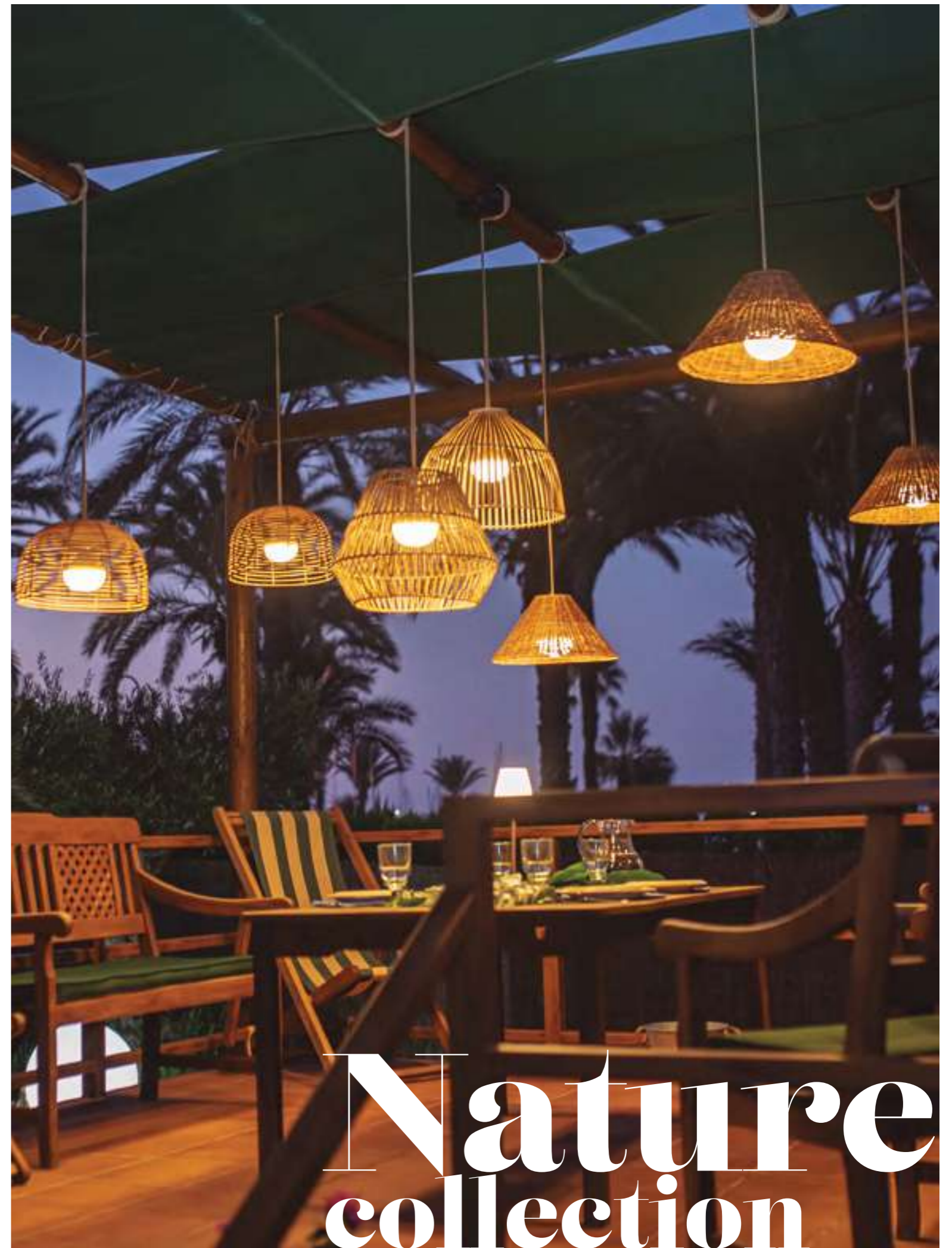
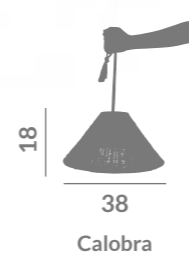



# Nature collection







# Norai



Options  
Light |  Battery   ø24  
+ Info P. 157  
Norai

# Bita



Options  
Light |  Battery   ø18  
29  
+ Info P. 156  
Bita

# Sora



Options  
Light |  Battery   ø24  
+ Info P. 156  
Sora



Norai



# Stella



## Options

Light  Cable   
+ Info P. 157

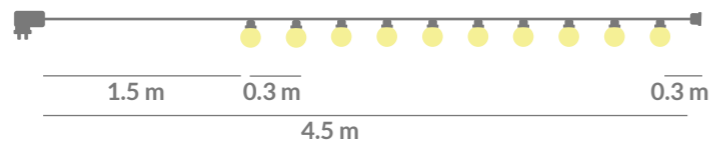

# Allegra



Allegra black

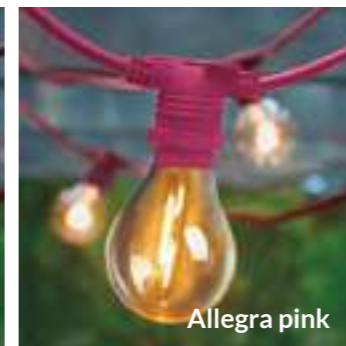

Allegra pink



Allegra black RGB



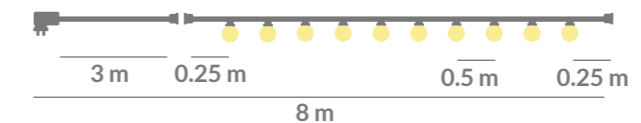

## Options

Light  Cable     
+ Info P. 157







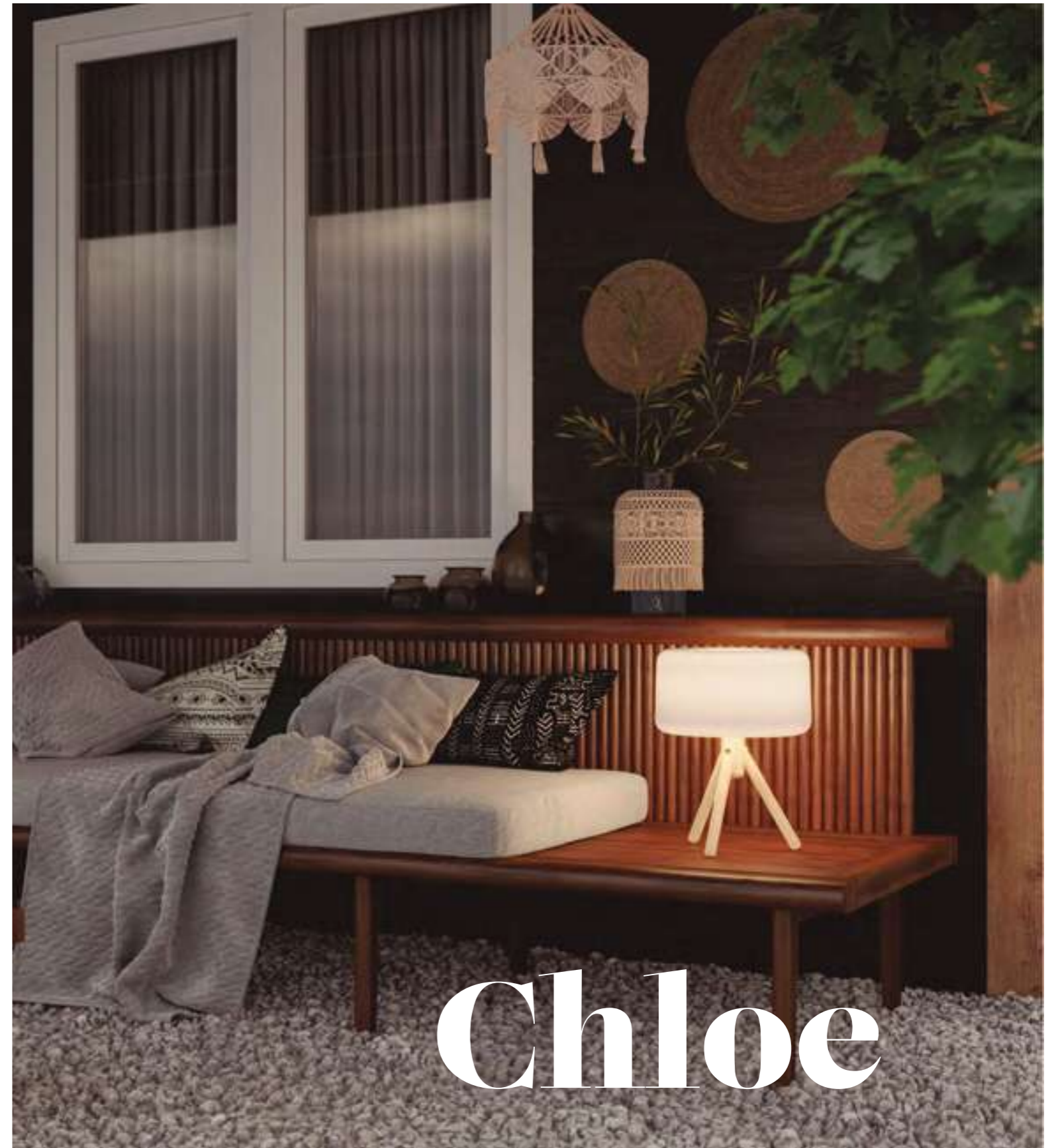

# Rudy

Options  
 Light |  Cable  
 Solar & battery   
 + Info P. 157

39x30  
 44  
  
 Rudy



# Chloe

Options  
 Light |  Cable  
 Solar & battery   
 + Info P. 160

ø28  
 36  
  
 Chloe 35

# Enoki

Options

Light



Battery



+ Info P. 159

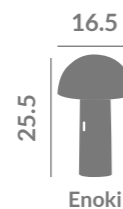



# Lola slim30

30 11  
**Options**  
**Light** | **Battery** ●●●●●●●●●●●●

Lola Slim 30      + Info P. 160



Antracite

Plum

Lime



Banana

Raspberry

Mint



Brass

Rose gold

Space grey



Lola 45

# Lola

Options

Light



Cable



Battery



+ Info P. 160, 161



Lola 20

Lola 30

Lola 45



# Panchito

Options

Light



Battery



+ Info P. 160

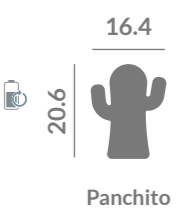

Panchito



Lola 20



Lola 30



# Rocket

Options

Light



Battery



+ Info P. 160

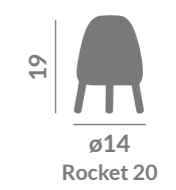

Rocket 20



# Mafalda

Options

Light	<input checked="" type="checkbox"/> Cable	<input type="checkbox"/> Battery	30	ø22
	<input checked="" type="checkbox"/>	<input type="checkbox"/>		

+ Info P. 161

Mafalda



# Carmen

Options

Light	<input checked="" type="checkbox"/> Cable	<input type="checkbox"/> Battery	45	ø29
	<input checked="" type="checkbox"/>	<input type="checkbox"/>		

+ Info P. 161

Carmen 45



# Candela

Options

Light



Cable Battery

+ Info P. 159

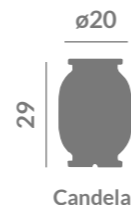

Candela



# Kurby

Options

Light



Play light&music  
Solar & battery

+ Info P. 159, 167



Kurby



# Nómada

Options

Light



Play light&music  
Solar & battery

+ Info P. 159, 166

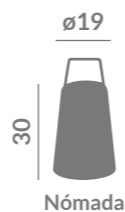

Nómada



# Faralay

Options

Light



Solar & battery  
Play light&music

+ Info P. 159, 166



Faralay

*take me where  
you want!*





# Robin play

Options

Light | Play light&music   
+ Info P. 166

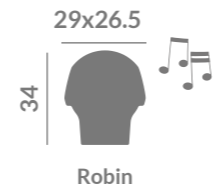

# Nipper

Options

Light | Play light&music   
+ Info P. 166

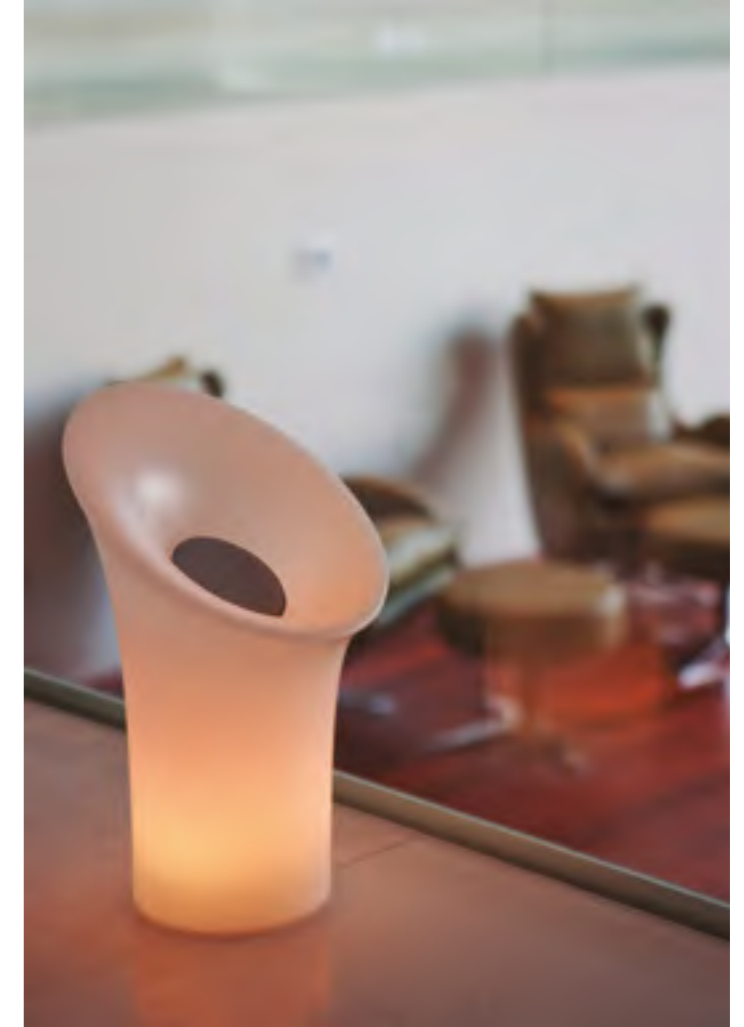

# Cuby play

Options

Light | Play light&music   
+ Info P. 167 - 171

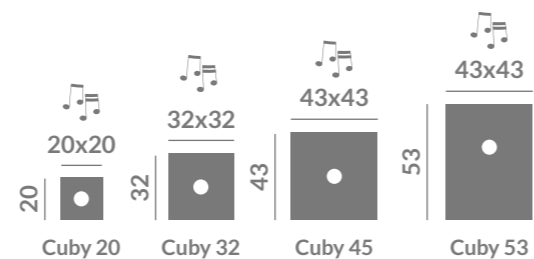

# Pipa

Options

Light | Play light&music   
+ Info P. 166

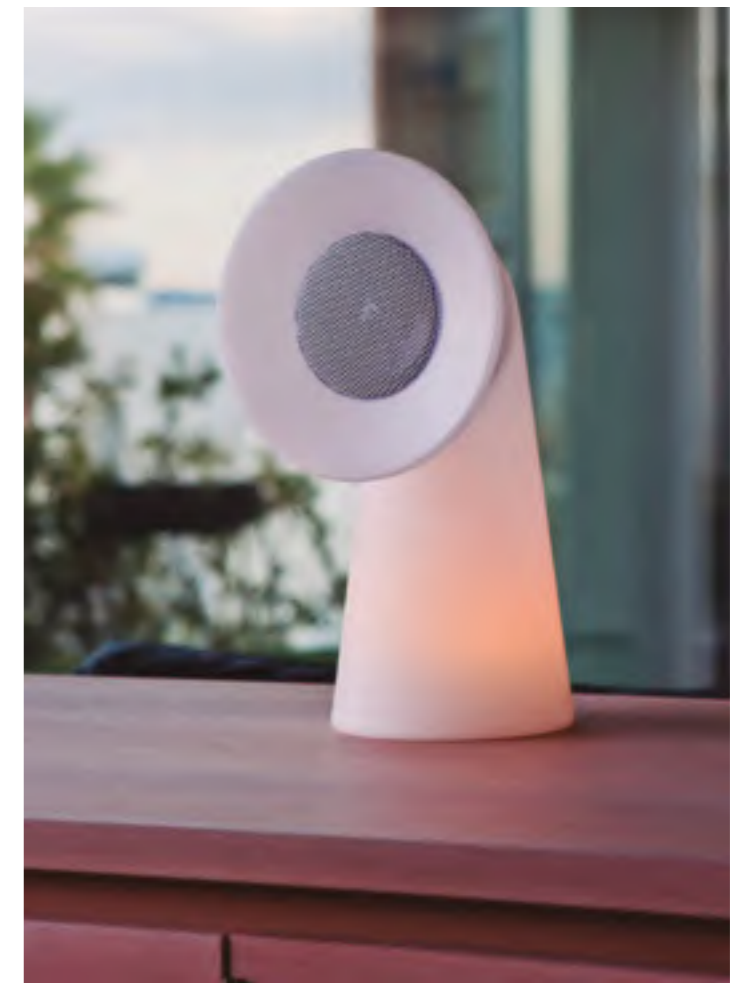



# Balby & buly hang

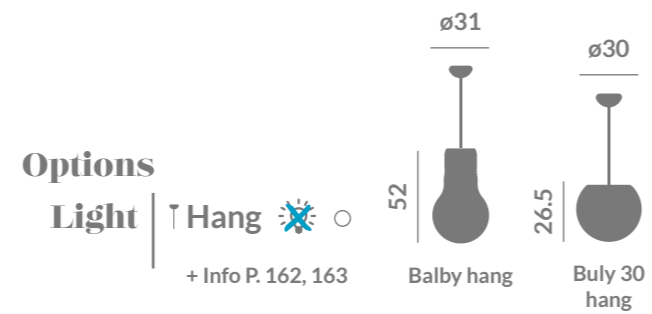

# Petra hang

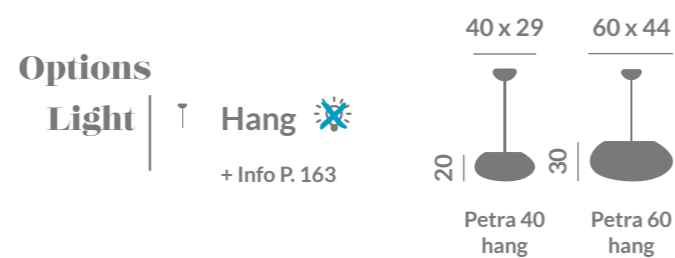

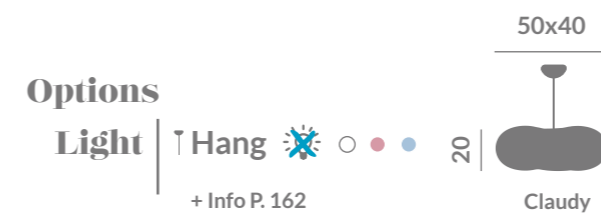

# Claudy hang





**Options**  
**Light**

  **Solar** 

+ Info P. 161

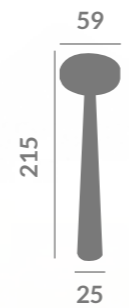

Paquita  
215  
farola



Paquita 40

# Paquita





Paquita wall

Paquita 215 farola

Paquita 40



# Cuby wall



# Lola wall



# Cápsula terpe



# Buly wall

Options  
Light | Wall    
+ Info P. 162

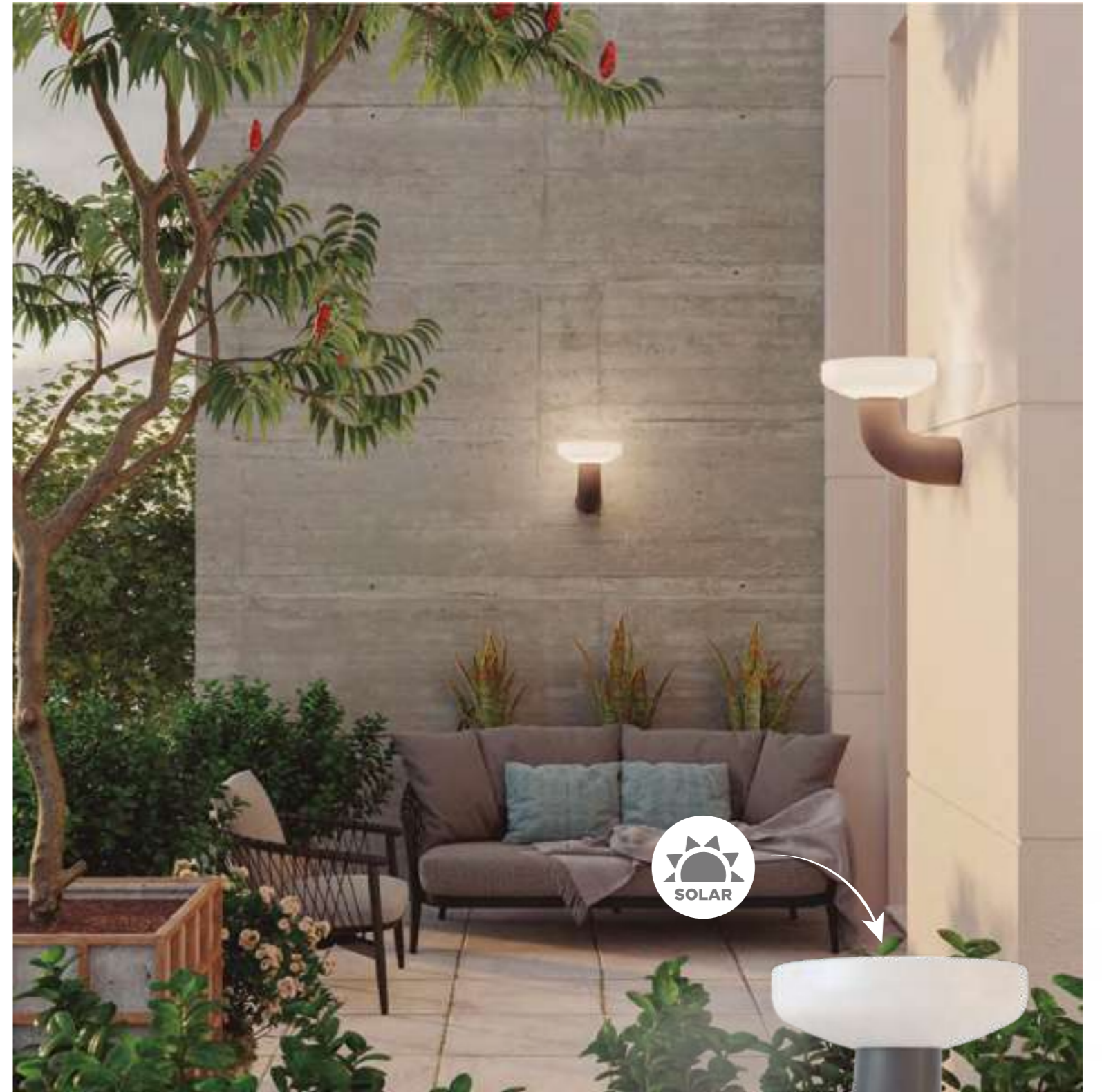
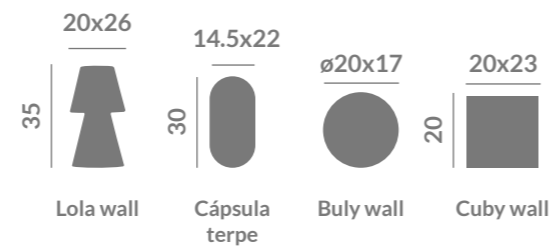

# Paquita wall

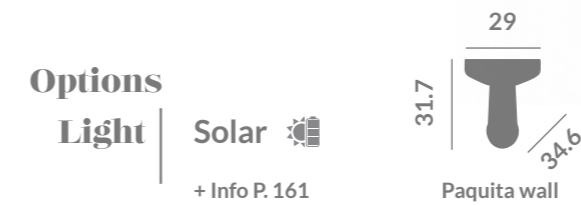



# Buly

*Do you prefer it with white light or with 256 colours?*

*Do you want it with solar & battery charge or with cable?*

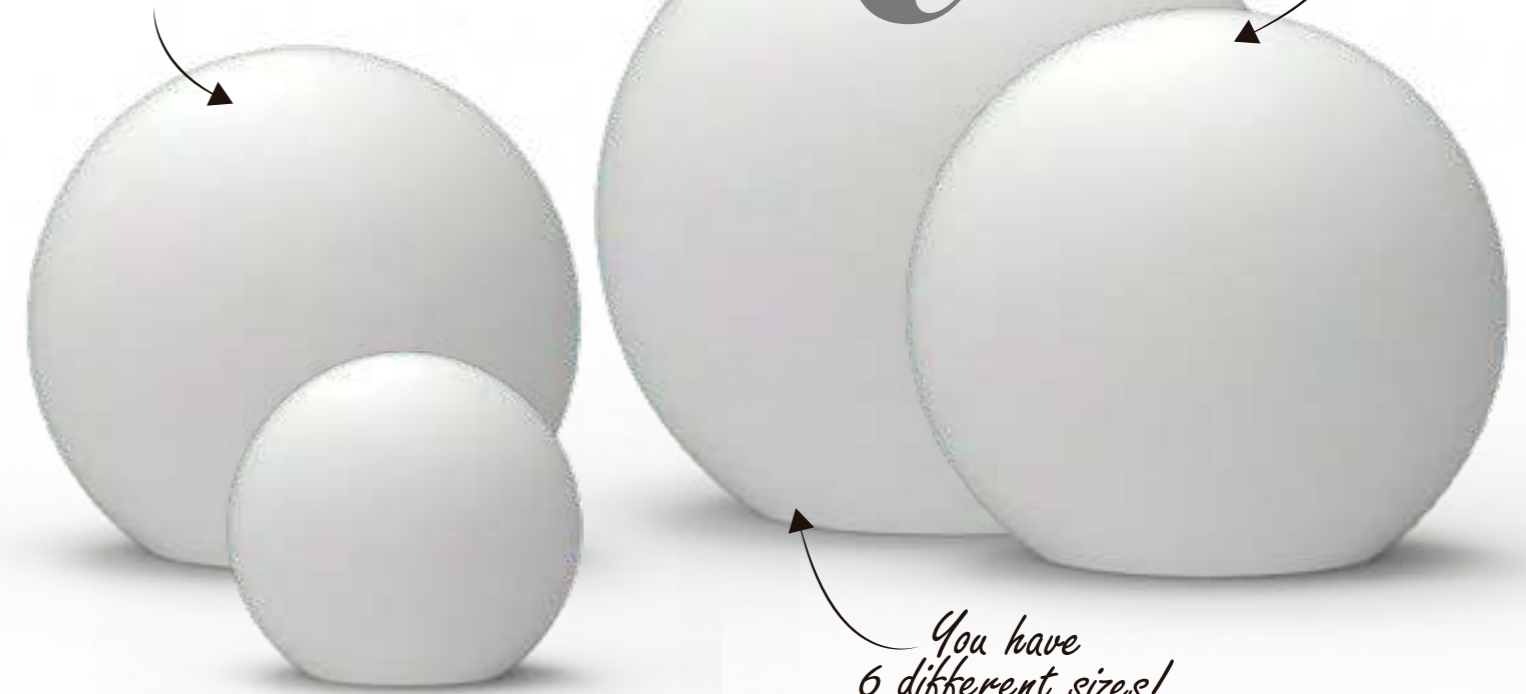

*You have 6 different sizes!*

LED

*choose your best option*

6 Sizes	Wireless	Solar charge & Rechargeable Battery	Cable	Floating
Remote Control	Colorfull Lighting	White Light	Translucent White	Translucent Granite

## Options

- Light  Cable
- Solar & battery
- Floating

+ Info P. 163, 164

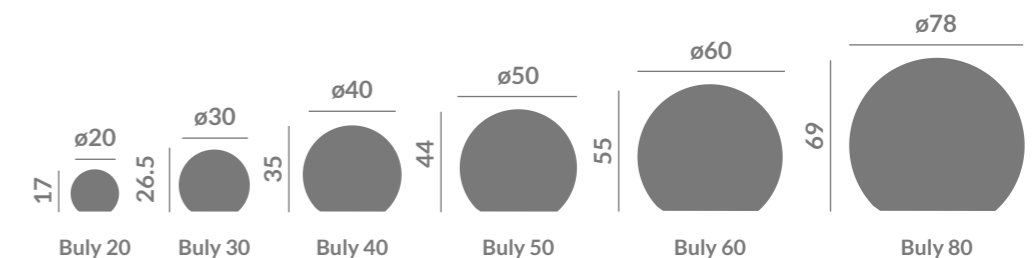

# Petra



## Options

- Light
  - Cable
  - Solar & battery
- + Info P. 165
- 40 x 29

20



Petra 40

60 x 44

30



Petra 60

# Cuby family



## Options

- Light
  - Cable
  - Solar & battery
- + Info P. 164, 165

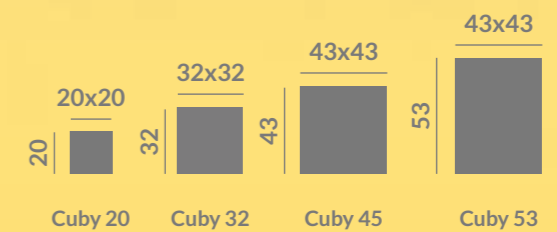

# Furniture

Originality makes the difference, it attracts curiosity and transmits special feelings, with a different and innovative touch. A safe bet if you want to escape from your routine and enter a world full of state-of-the-art and daring ideas, provided by Newgarden.

Trends, lights, shapes and, above all, best friends.





Put your  
brand  
here!



**Customize  
our products**

ASK FOR QUOTATION!



Options

Color 

203x80

37



Rasa

+ Info P.172

# Rasa



Options

- Light |  Cable
- Solar + Battery 

Color |

Textile accessories

+ Info P. 172



# Formentera

# Jamaica, Aruba & Martinica

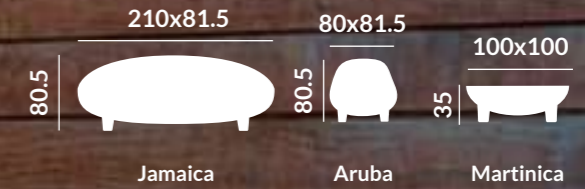

## Options

- Light** | Cable Solar + battery

- Color** | ● ○ ○  
+ Info P. 170, 172



New Island





Tarida sit

# Tarida



## Options

Light  Solar & battery  
 Play light&music

Color      
 + Info P. 170, 172, 173

	77x59	45x59	77x69
66		30	66
	Tarida sit	Tarida tab	Tarida sit arms

Tarida sit textil accessory included  
 Tarida tab cover included





# Capri & Mallorca



# Itaca & Mallorca

**Options**

- Light** | Cable  
 Solar + Battery

- Color** |

+ Info P. 169, 173, 170

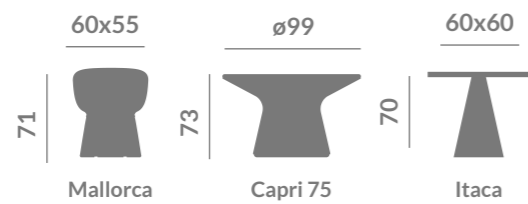

Tables cover included  
 Itaca weight stability included



# Menorca sofá

## Options

Light  Cable  Solar + Battery

Color

+ Info P. 173



Menorca  
sofá



# Menorca bench

## Options

Light  Cable  Solar + Battery

Color

+ Info P. 173

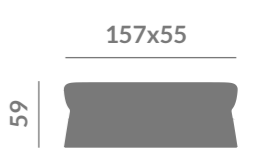

Menorca bench





# Calvin & Melvin

## Options

**Light**  Solar + Battery  Play light&music

**Color**

+ Info P. 173, 170

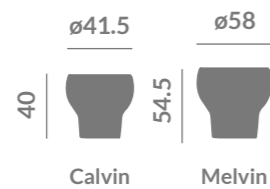

Melvin cover included



# Cuby play

## Options

**Light**  Play light&music

+ Info P. 167 - 171

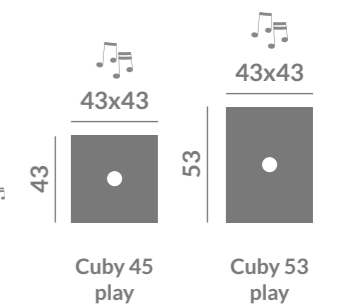

Bora  
wood



Bora  
Marble



Bora Marble



Bora Wood

# Bora

Options

Light  Cable

Color

+ Info P.171





# Cuby

## Options

Light | Cable  
 Solar + Battery

+ Info P. 171

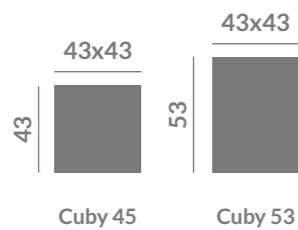

# Bricky

## Options

Light | Cable

Color |

+ Info P. 174

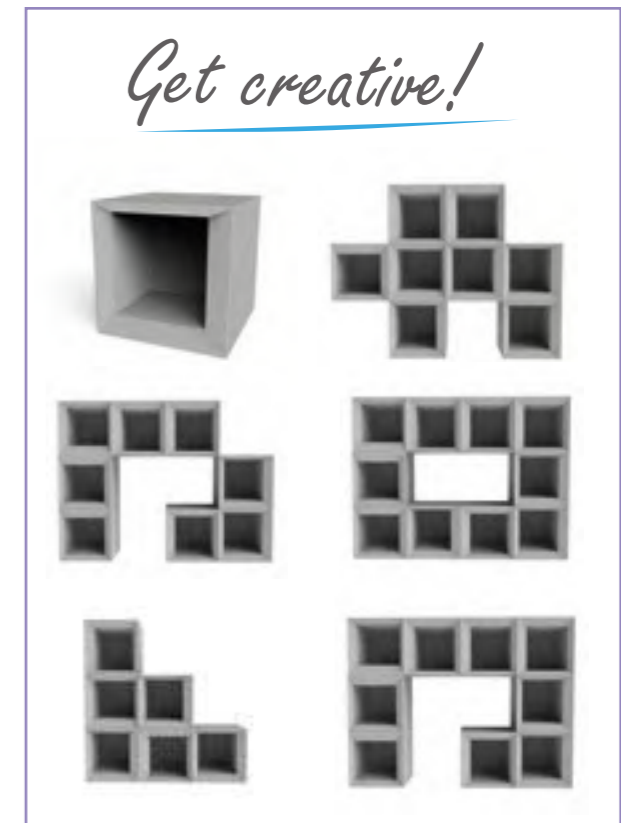





# Sicilia

### Options

- Light  Cable  Solar + Battery

### Color

+ Info P. 175



Sicilia 75



Sicilia 120

# Ibiza



## Options

- Light  Cable  Solar + Battery

Color

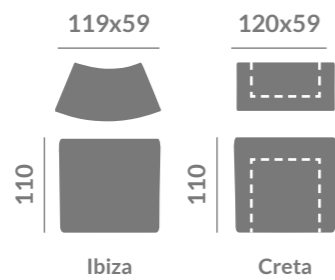

+ Info P. 175

Cover included - Shelf not included

# Creta





## Palma bottle rack

**Options**

**Light** |  Cable  Solar + Battery

**Cooler accessory**

+ Info P. 175

Palma bottle rack



## Woody

**Options**

**Light** |  Play light&music

**Cooler accessory included**





+ Info P. 175

Woody

# Capri & Corfu



## Options

- Light** |  Cable  
 Solar + Battery   
 Battery 

**Color** | ● ● ●



Capri cover included



# Bahama

**Options**

Light |  Battery

Color | ● ● ● ●

+ Info P. 169

Cover included



# Pufy & Tafy

**Options**

Color | ○ ● ● ● ●

+ Info P. 174

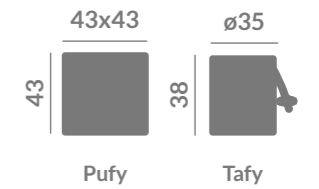

# Capri & Corfu

**Options**

Light |  Solar + Battery

Color | ○ ● ● ●

+ Info P. 169, 174

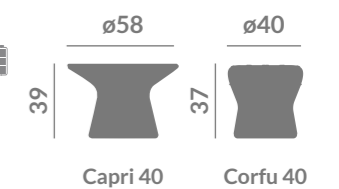

Capri cover included

# Flowerpots

## Flowerpots

Life emanates from plants, capable of bringing unique sensations of peace to every corner and attracting all eyes. The range of Newgarden planters has managed to capture that feeling along with unique and innovative designs. Giving your garden an original touch and a feeling of tranquillity.

Nature, life, harmony... and endless possibilities to be explored.







Magnolia 60



Magnolia 130

Options

- Light | Cable  
 Solar & battery

- Color |

+ Info P. 180, 181

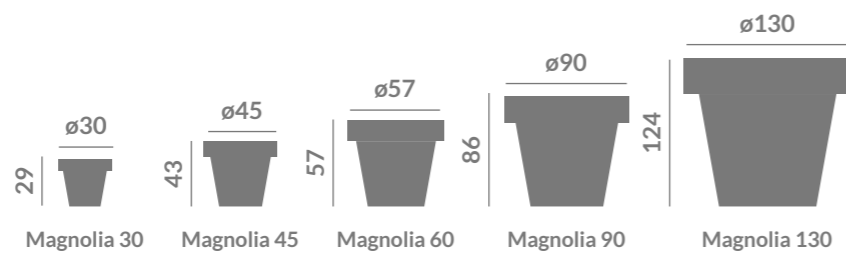

Magnolia



**Options**

**Light** | Cable  
 Solar & battery

**Color** |   
 + Info P. 181

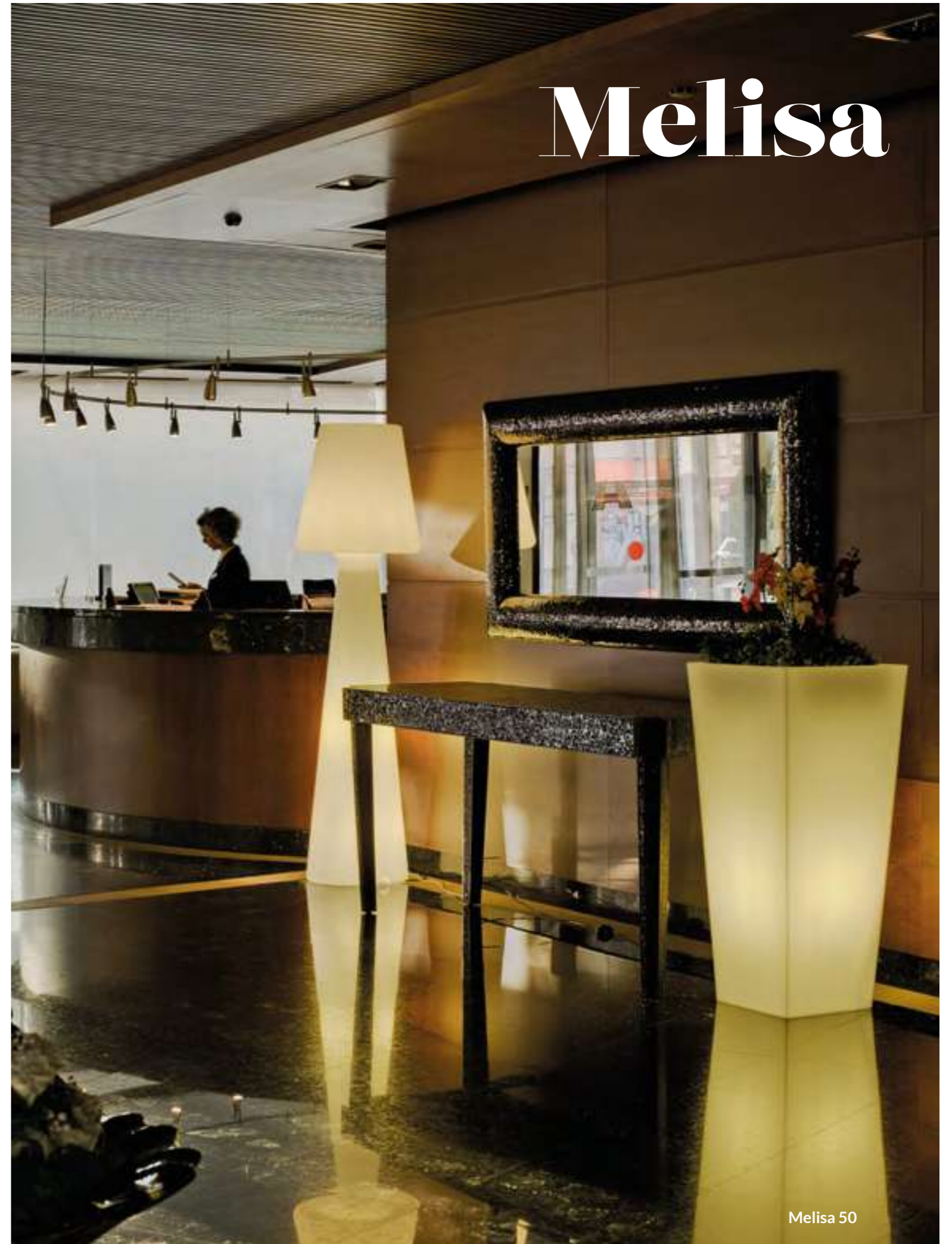
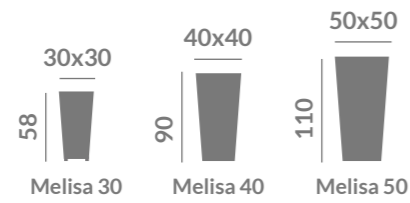

Melisa 50



Options

- Light** |  Cable  Solar & battery  Battery

- Color** |

+ Info P. 177, 178

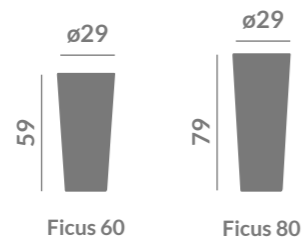

**Ficus**

Options

- Light** |  Cable  Solar & battery  Battery

- Color** |

Cooler accessory

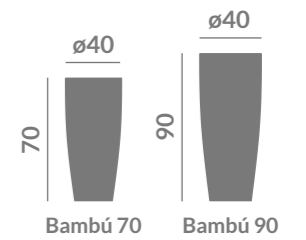

**Bambú**

Bambu 70



**Options**

- Light** |  Cable  Solar & battery

- Color** |

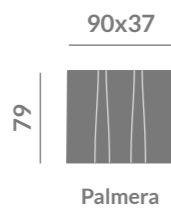

# Palmera



**Options**

- Light** |  Cable  Solar & battery

- Color** |



# Junco





# Jara

## Options

Color | ○ ● ● ● ●

+ Info P. 179, 180

	100x35	100x40
32		
	Jara 100x35	Jara 100x40



# Narciso

## Options

Light |  Cable  Solar & battery

Color | ○ ● ● ● ● ● ● ● ●

+ Info P. 182

	40x40	49x49	59x59
36			
	Narciso 40	Narciso 50	Narciso 60



Options

Light  Cable  
 Solar & battery 

Color 

+ Info P. 176, 177

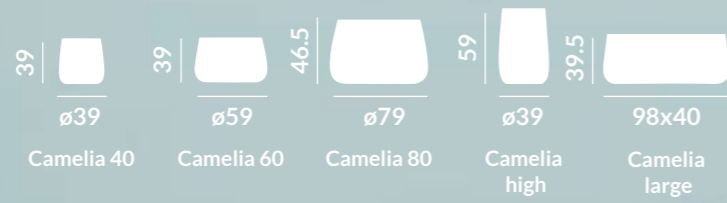

# Camelia



# Palma



## Options

Light |  Cable  
 Solar & battery

Color |   



Palma 70

# Hiedra



## Options

Light |  Cable

Color |   

+ Info P. 178

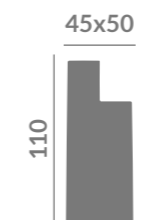

Hiedra





# Christmas

## Christmas

Christmas is a mood, days to share, to sing Christmas carols, to meet up with family and old friends. It is an indescribable feeling where joy is always present. At Newgarden we want to accompany you and illuminate all your special moments.

Illusion, light, colour, family... but above all, days full of magic.



# Amelio

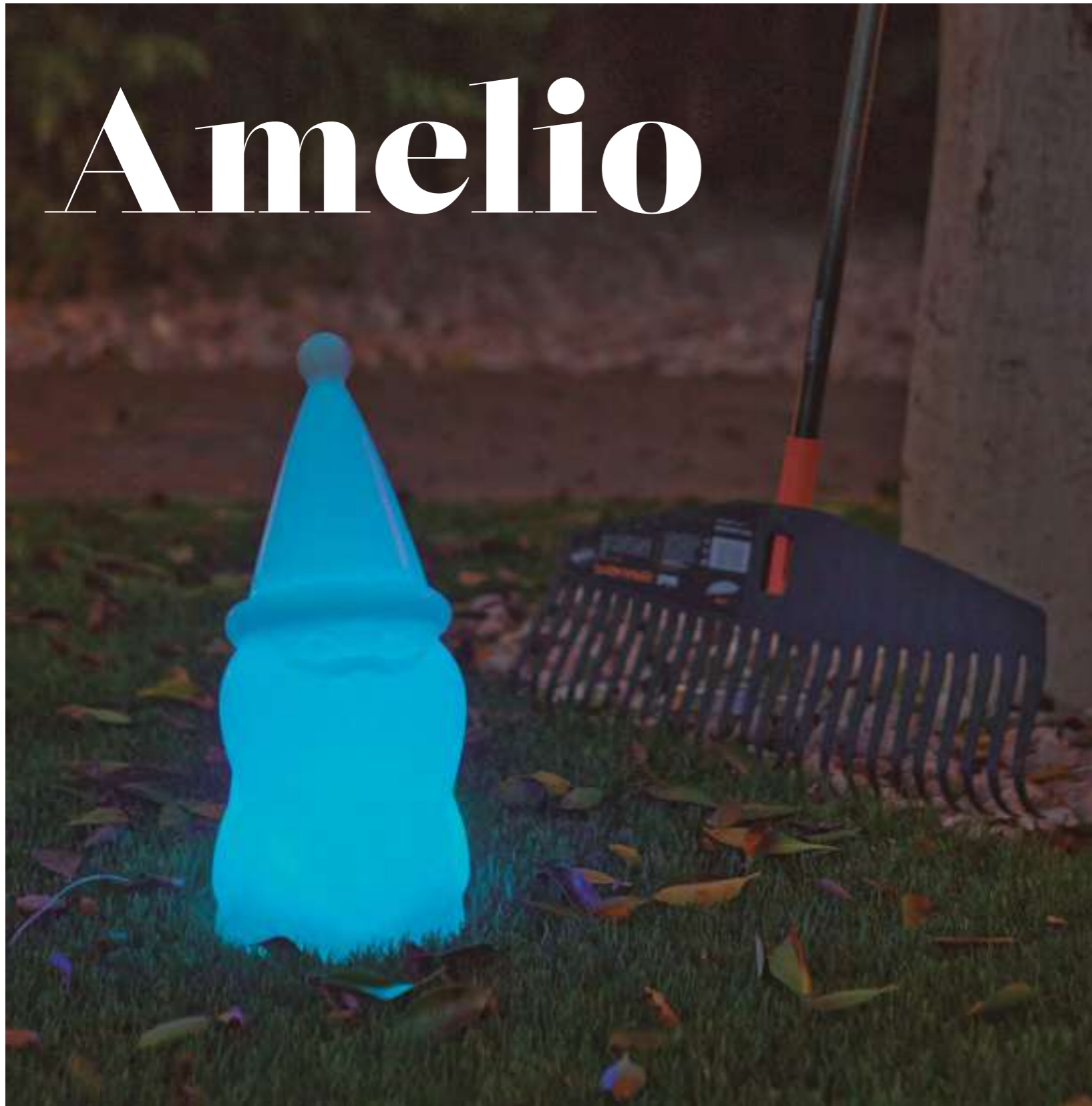

Options  
Light

- Cable
- Solar & battery

+ Info P. 158



# Snowy

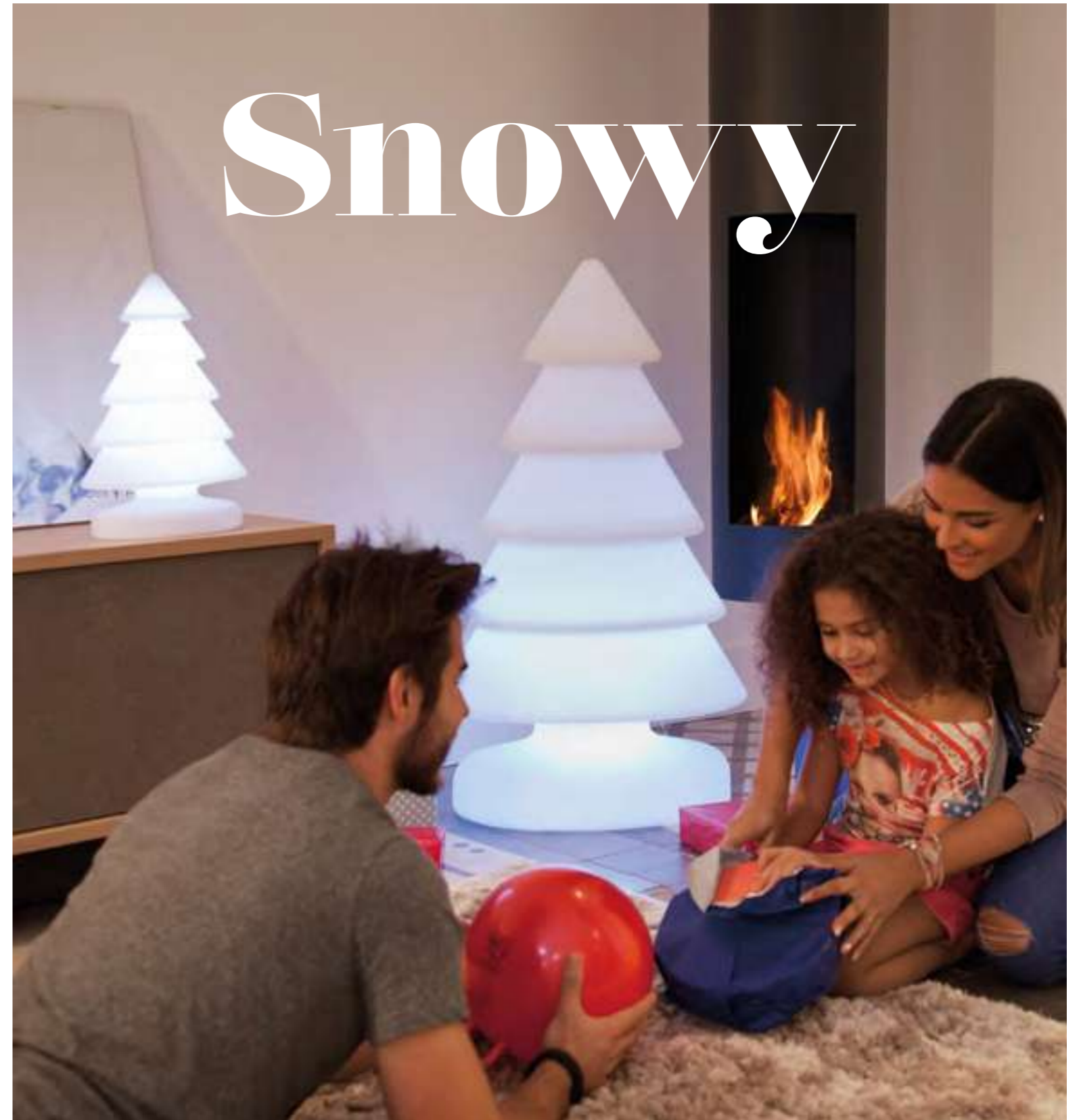

Options  
Light

- Cable
- Solar & battery
- Battery

+ Info P. 168

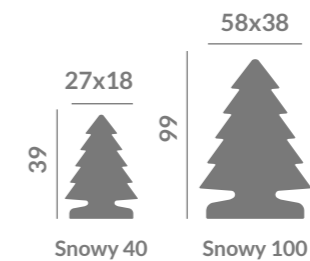

Options  
Light

- Cable ●●
- Solar & battery ☀️ ●
- Battery 🔋 ●

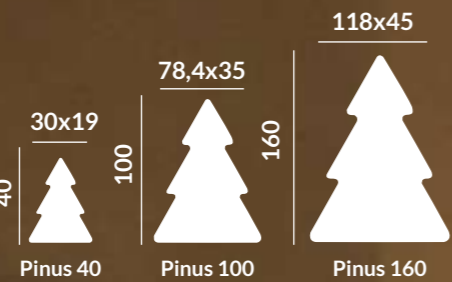

+ Info P. 167, 168



# Nova

## Options

- Light
- Cable
- Solar & battery
- Battery

+ Info P. 168, 169



# Klaus

## Options

- Light
- Play light&music

+ Info P. 169

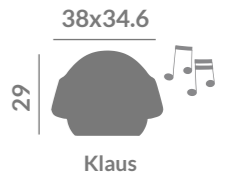



TECHNICAL DATA



## 1. Properties

## 2. Materials

## 3. Plastic finishes and colors

## 4. Maintenance and security recommendations

## 5. Cleaning

## 6. Lighting system

## 7. Measurement and references

### . Lighting

- . Floor lamps
- . Decorative
- . Table lamps
- . Functional
- . Essentials
- . Speakers
- . Christmas

### . Furniture

- . Tables
- . Seats
- . Bar

### . Flowerpots

## 8. Place a Bulb / Tube

## 9. Bar fixation kit

## 10. Fixation

## 11. Planting system

## 1- PROPERTIES

PE

LMDPE resin, linear medium density  
**Polyethylene**

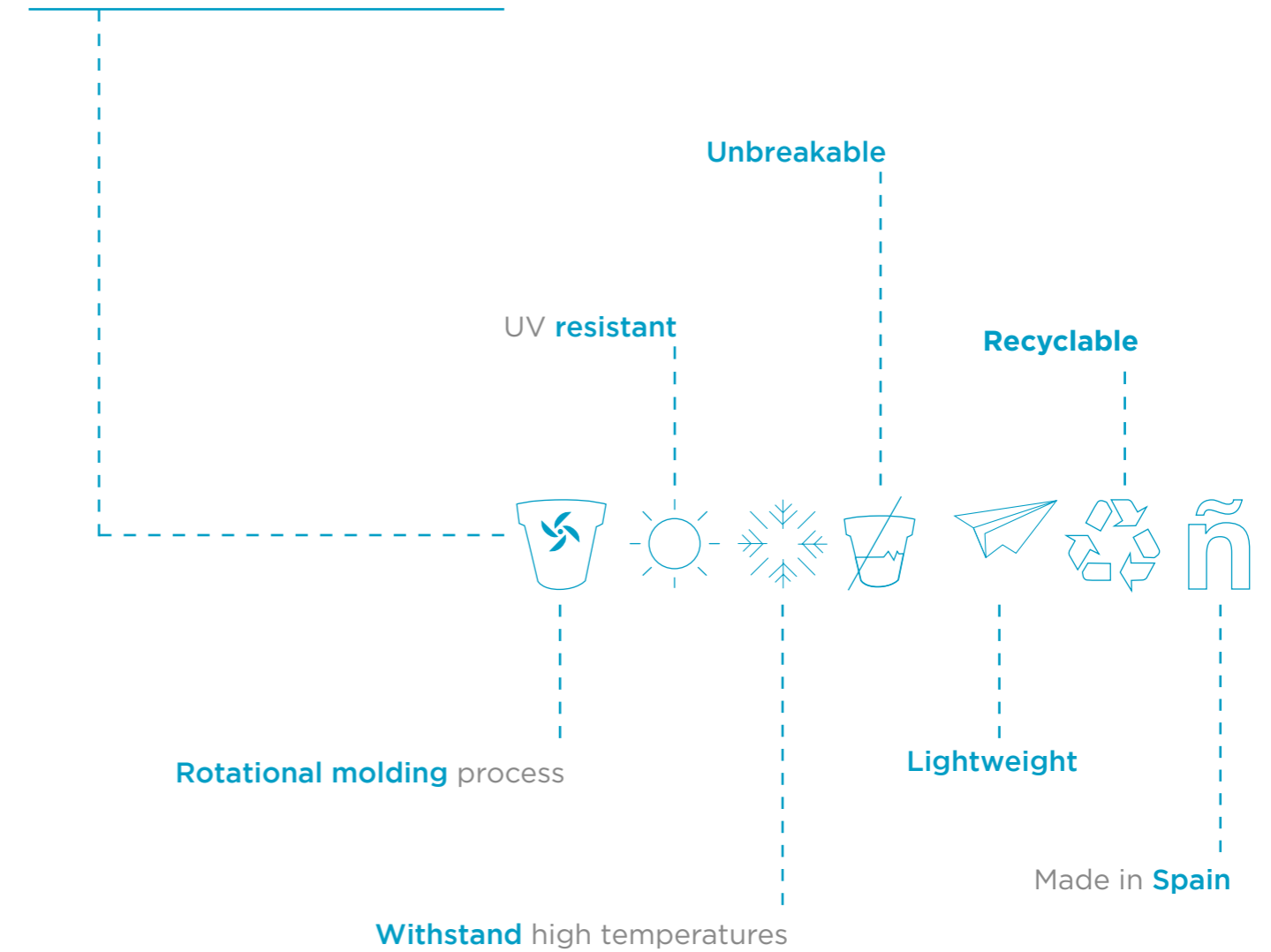

## 2- MATERIALS

### MATERIAL Polyethylene



Polyethylene LMDPE

Good physical properties  
Easy Molding  
UV Stabilised  
100% Recyclable  
Outdoor use and indoor use

### MATERIAL Rudy



Pine wood

Natural barnish  
Indoor use and moderated outdoor use  
Magnetic connection, no installation required

### MATERIAL Betty, Rocket, Chloe



Beech wood

Natural barnish.  
Indoor use and moderated outdoor use

### MATERIAL Bahama, Tarida tab, Capri, Ibiza, Creta



Methacrylate

High resistance to external aggressions  
Non-porous surface

### MATERIAL Bora Wood, Tarida sit arms

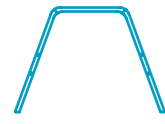

Bamboo.  
Natural barnish.  
Outdoor use and indoor use.

### MATERIAL Itaca, Creta accesory



Phenolic compounds  
High pressure laminate.  
High resistance to external aggressions.  
Non-porous surface. Waterproof.

### MATERIAL Helga, Chloe Plant, Lola Slim



Painted iron.  
High resistance to external aggressions.  
Outdoor use and indoor use.

### WEIGHT Paquita, Flyt



Steel.

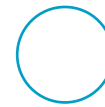

High resistance to external aggressions.

### MATERIAL Nature Collection



Natural fibers.  
Outdoor use and indoor use.

### MATERIAL Bora Marble



Ceramic.  
High resistance to external aggressions.  
Outdoor use and indoor use.

### MATERIAL Enoki



ABS.  
Outdoor use and indoor use.

### MATERIAL Candela, Kurby, Woody, Faralay



Vegan leather.  
Synthetic leather. Polyurethane.  
Indoor use and moderated outdoor use.

### MATERIAL Fabric



Composition: 80% pvc 18% pes 2% pu  
Mlineal weight: 550 g  
Abrasion resistance 25000 martindale cycle.  
Light strenght 5/5.  
Dry rub fastness 4-5 wet -5.  
Tears weave resistance 24.5n/29.4n.  
Break weave resistance 588n/784n.

### PLASTIC HANDLE Nómada



Polyamide.  
Fiber glass hardened.

### COOLER



Aluminium.  
Tickness 1.5 mm  
Outdoor use and indoor use.

### MATERIAL Allegra, Stella



PVC.

### MATERIAL Panchito, Rocket 20



Silicone.

## 3- POLYETHYLENE FINISHES

### TEXTURES

Smooth



Rustic



### TRANSLUCENT COLORS

Translucent white



Translucent lime



Translucent blue



Translucent granite



Translucent green



Translucent pink



### OPAQUE COLORS

White (B)



Bronze (Z)



Soft pink (R)



Black (N)



Grey (S)



Soft blue (C)



Topo (K)



Terracotta (T)



Soft green (V)



## 4- MAINTENANCE AND SECURITY RECOMMENDATIONS

To ensure safe and enduring performance of our products, please read the following information:

1. Products can cause skin damage due to sun exposure (especially dark colors). Please make sure to check the temperature before using.
2. Place the piece on flat surfaces to prevent unbalanced.
3. Keep away from excessive heat sources
4. This is a decoration, not a toy. Keep away from children.
5. Always unplug before changing the light bulb.
6. Damaged cable should be replaced by the supplier or a qualified professional only.
7. If the LED lighting system does not work, contact the manufacturer for assistance.
8. Connection plugs should have the degree of protection according to outdoor luminaires.
9. Do not use in case of damaged luminaire.
10. Please, follow closely the instructions contained in the manual user.

## 5- CLEANING

Newgarden products are easy to clean up. Steps to clean the piece:

1. Spray a degreaser product or detergent to clean the surface.
2. Rub with a damp cloth or water.
3. Rinse with abundant water.



## 6- LIGHTING SYSTEM

### OUTDOOR CABLE



Cable: 7 mm Ø  
Black

Outdoor cable  
2 m / 4 m

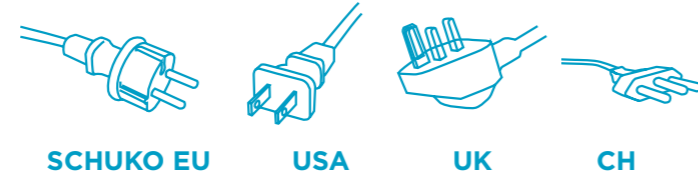

SCHUKO EU

USA

UK

CH

### OUTDOOR CABLE (Allegra, Stella)

Allegra  
Black, Pink:  
Lenght:  
8 m

IP44

Outdoor and  
indoor



Connect up  
to 4 garlands

Stella:  
Lenght:  
4,5 m

IP44

Outdoor and  
indoor



Vintage  
Design

Allegra  
RGB:  
Lenght:  
8 m

IP44

Outdoor and  
indoor



Multicolor  
light



Remote  
control



Connect up  
to 5 garlands

### IN&OUT CABLE



HEMP  
cable

Outdoor cable  
2 m/4m



SCHUKO EU

Cable: 8.5 mm Ø  
Lenght: 2150 mm/4000 mm  
Black

### INDOOR CABLE



Cable: 3x5 mm  
Lenght: 1500+1000 mm  
Footswitch  
Black or transparent

European plug

Foot switch

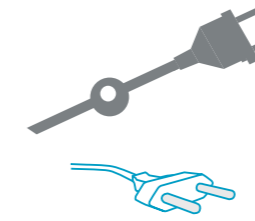

Hand switch

Cable: 3x5 mm  
Lenght: 1200+800 mm  
Hand switch  
Transparent

European plug

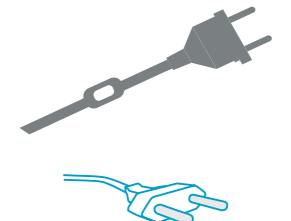

### BULBS



Cool light  
6000/6500°K  
Base E27



Warm light  
2700-3000°K



IN&out  
2700°K / 6500°K



Warm light  
Rechargeable  
2700°K  
500 LUMENS  
POWER 5W  
BATT 5400mAh  
INPUT 5V DC 2A MAX

NANO PC  
9-22 W A+  
85-265VAC  
900-2200 lumens  
48-168 LEDS  
>25.000 hours



Plug G13



Cool light  
6000/6500°K



Warm light  
2700-3000°K



PATENTED  
SYSTEM

\*Characteristics may vary depending on future updates or product improvements

### PLAY: LIGHT & MUSIC



Bluetooth



LED  
technology



Multicolor light  
+white



Remote control



Charger



4-6 hours



8-12 hours



Protect from  
humidity. Avoid  
direct contact with  
water.

### SOLAR (Paquita Family)



Night mode /  
Manual mode /  
Move sensor



LED  
technology



No electrical  
installation  
required



Remote control

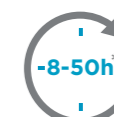

8-50 hours



Outdoor and  
indoor

## SOLAR+RECHARGEABLE BATTERY (Smarttech 2.0)

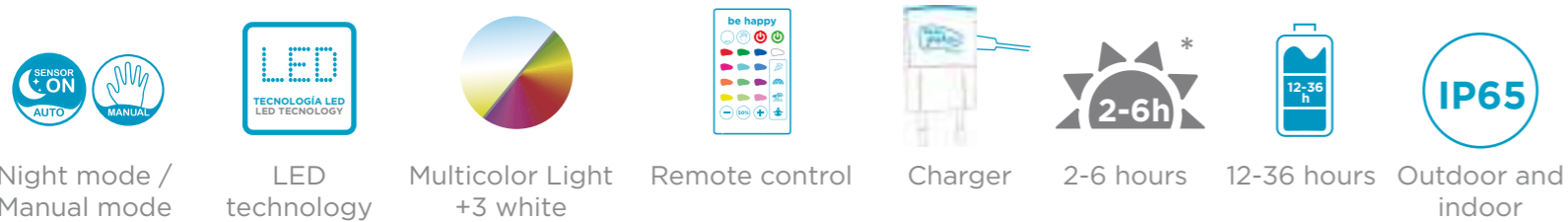

With this mode, the product will automatically turn on when an ideal level of darkness is detected.



With this mode, you can turn the product on and off to your liking.

### Charge vs autonomy

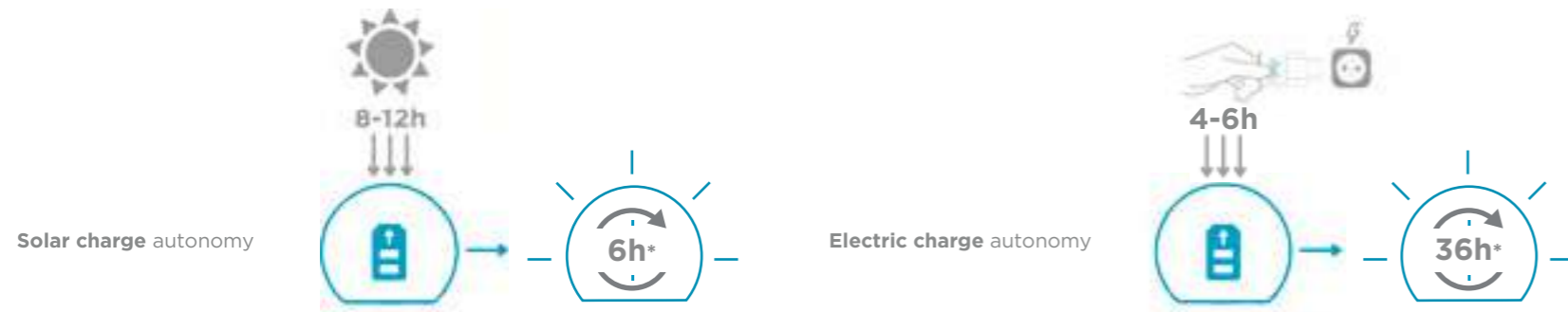

\*Following models have different electrical and solar charge autonomy. BULY 80, CHLOE 140, FITY 100, FREDO 140, FREDO 170, HIEDRA, KAKTUS, MAGNOLIA 90, PANCHO, PINUS 100, PINUS 160, ROCKET SNOWY 100.

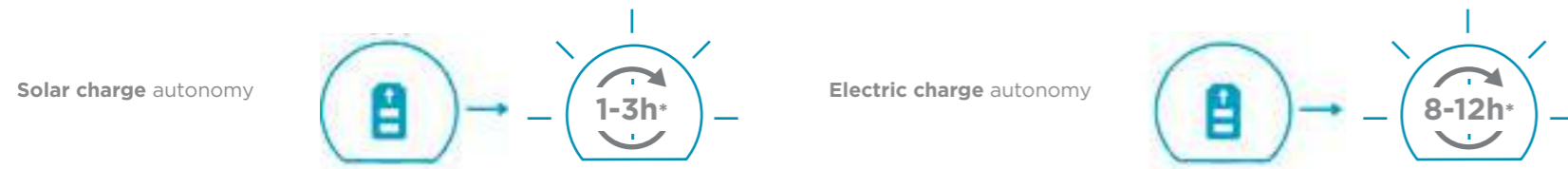

### Remote control



- Night mode.
- Higher light intensity.
- Party mode.
- Manual mode.
- Lower light intensity.
- Flash mode.
- TurnOff.
- 50% intensity of light.
- Relax mode.
- Turn On.
- White light.
- Chakras mode.

#### Trending colors



SMARTTECH FLOATING

Buly 30 and buly 40 are smarttech floating



Outdoor and floating

## RECHARGEABLE BATTERY



## RECHARGEABLE BATTERY (Bossa, Calobra, Reona & Sisine)

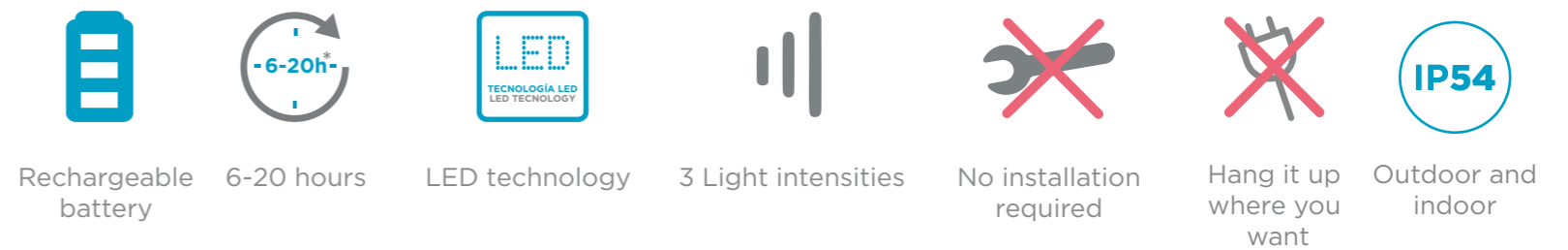

## RECHARGEABLE BATTERY (Lola Slim 30, Enoki)

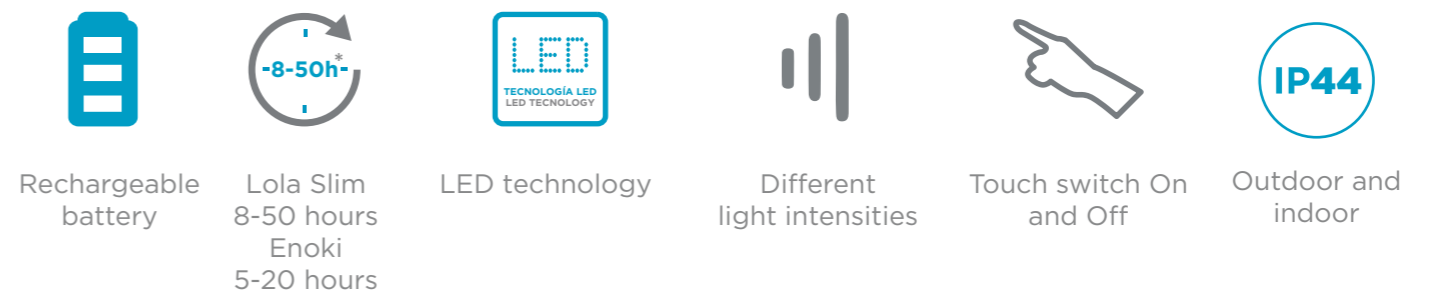

## WALL + HANG



Bulb not included



# 7- MEASUREMENT AND REFERENCES

Due to the manufacturing process, product dimensions may vary slightly. The dimensions of the packaging can vary due to adjustments in the improvement process.

## LIGHTING

### FLOOR LAMPS

**LOLA SLIM 120**

**DIMENSIONS CM**

**PACKAGING**

**Options**

- Smarttech (solar & rechargeable battery) rose gold color\_\_LUMLLS120RGSSNW
- Smarttech (solar & rechargeable battery) brass color\_\_LUMLLS120BRSSNW
- Smarttech (solar & rechargeable battery) space grey color\_\_LUMLLS120GESSNW
- Smarttech (solar & rechargeable battery) antracite color\_\_LUMLLS120ANSSNW

Weight: 7 kg

**REFERENCES**

**LOLA SLIM 180**

**DIMENSIONS CM**

**PACKAGING**

**Options**

- In&out cable (indoor & outdoor use) rose gold color \_\_LUMLLS180RINOUTNW
- In&out cable (indoor & outdoor use) brass color \_\_LUMLLS180BINOUTNW
- Smarttech (solar & rechargeable battery) rose gold color\_\_LUMLLS180RSSNW
- Smarttech (solar & rechargeable battery) brass color\_\_LUMLLS180BSSNW

Weight: 20 kg

**REFERENCES**

**CHLOE PLANT**

**DIMENSIONS CM**

**PACKAGING**

**Options**

- Smarttech (solar & rechargeable battery) mint color\_\_LUMCHLPLTMNSSNW
- Smarttech (solar & rechargeable battery) wood\_\_LUMCHLPLTSSNW

Weight: 13,5 kg

**REFERENCES**

**CHLOE**

**DIMENSIONS CM**

**PACKAGING**

**Options**

- In&out cable (indoor & outdoor use) \_\_LUMCHL140INOUTNW
- Indoor cable / warm light\* \_\_LUMCHL140ICNW
- Smarttech (solar & rechargeable battery) \_\_LUMCHL140SSNW

Weight: 5,2 kg

**REFERENCES**

**ROCKET 70**

**DIMENSIONS CM**

**PACKAGING**

Weight: 2,2 kg

**Options**

- In&out cable (indoor & outdoor use) \_\_LUMRCK070INOUTNW
- Indoor cable / warm light\* \_\_LUMRCK070ICNW
- Smarttech (solar & rechargeable battery) \_\_LUMRCK070SSNW

**\*BASE**

Base E27

x 1 \*Supplied

**REFERENCES**

**ROCKET 145**

**DIMENSIONS CM**

**PACKAGING**

Weight: 8 kg

**Options**

- In&out cable (indoor & outdoor use) \_\_LUMRCK145INOUTNW
- Indoor cable / warm light\* \_\_LUMRCK145SSNW
- Smarttech (solar & rechargeable battery) \_\_LUMRCK145ICNW

**\*BASE**

Base E27

x 1 \*Supplied

**REFERENCES**

**FITY 100**

**DIMENSIONS CM**

**PACKAGING**

Weight: 4,7 kg

**Options**

- In&out cable / white light\* (indoor & outdoor use) \_\_LUMFT100OFNW
- In&out cable / warm light\* (indoor & outdoor use) \_\_LUMFT100OCNW
- Battery\* \_\_LUMFT100TDLNW

Weight stability included

**REFERENCES**

**FITY 160**

**DIMENSIONS CM**

**PACKAGING**

Weight: 6,2 kg

**Options**

- In&out cable / white light\* (indoor & outdoor use) \_\_LUMFT160OFNW
- In&out cable / warm light\* (indoor & outdoor use) \_\_LUMFT160OCNW
- Battery\* \_\_LUMFT160TDLNW

Weight stability included

**REFERENCES**

**GRACE 140**

**DIMENSIONS CM**

**PACKAGING**

Weight: 6,5 kg

**Options**

- Outdoor cable / white light \* \_\_LUMGC140OFNW
- Battery\* \_\_LUMGC140TDLNW

All finishes // Floor anchorage included.

**REFERENCES**

**GRACE 170** DIMENSIONS CM

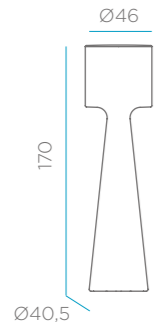

PACKAGING

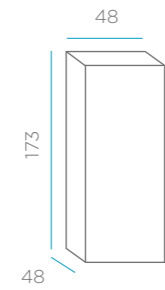

Weight: 7.6 kg

All finishes // Floor anchorage included.

Options

- Outdoor cable / white light\* \_\_\_\_\_ LUMGC170OFNW
- Battery\* \_\_\_\_\_ LUMGC170TWLNW

REFERENCES



**LOLA 200** DIMENSIONS CM

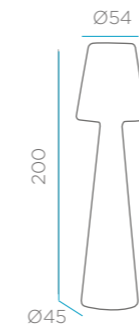

PACKAGING

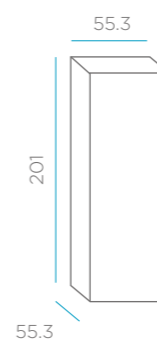

Weight: 12.5 kg

All finishes // Floor anchorage included.

Options

- Outdoor cable / white light\* \_\_\_\_\_ LUMLL200FNW
- Indoor cable / warm light\* \_\_\_\_\_ LUMLL200ICNW

REFERENCES



**HELGA**

DIMENSIONS CM

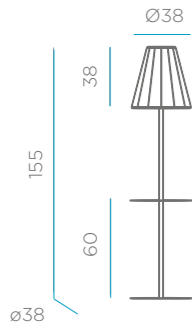

PACKAGING

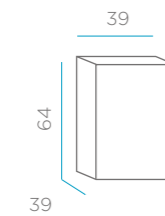

Weight: 10 kg

All finishes // Floor anchorage included.

Options

- Smarttech (solar & rechargeable battery)+ USB antracite color \_\_\_\_\_ LUMHLA165SSNW
- Smarttech (solar & rechargeable battery)+ USB soft pink color \_\_\_\_\_ LUMHLRS165SSNW
- Smarttech (solar & rechargeable battery)+ USB green color \_\_\_\_\_ LUMHLV165SSNW

REFERENCES



**CARMEN 110** DIMENSIONS CM

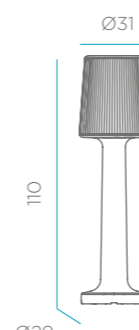

PACKAGING

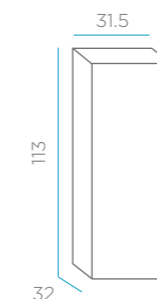

Weight: 4.5 kg

All finishes // Floor anchorage included.

Options

- Outdoor cable / white light\* \_\_\_\_\_ LUMCR110OFNW
- Indoor cable / warm light\* \_\_\_\_\_ LUMCR110ICNW
- Battery\* \_\_\_\_\_ LUMCR110TWLNW

REFERENCES



**PANCHO**

DIMENSIONS CM

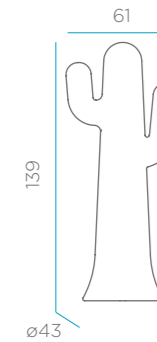

PACKAGING

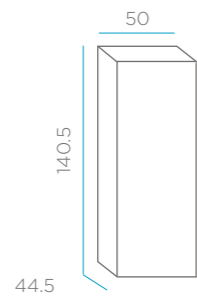

Weight: 6 kg

All finishes // Floor anchorage included.

Options

- Lime/ Outdoor cable / white light\* \_\_\_\_\_ LUMPV140OFNW
- Outdoor cable / white light\* \_\_\_\_\_ LUMPC140OFNW
- Battery\* \_\_\_\_\_ LUMPC140TWLNW

REFERENCES



**CARMEN 165** DIMENSIONS CM

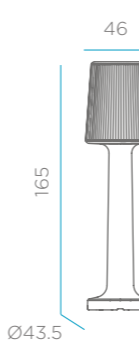

PACKAGING

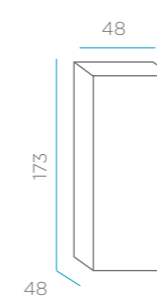

Weight: 8.5 kg

All finishes // Floor anchorage included.

Options

- Outdoor cable / white light\* \_\_\_\_\_ LUMCR165OFNW
- Indoor cable / warm light\* \_\_\_\_\_ LUMCR165ICNW
- Battery\* \_\_\_\_\_ LUMCR165TWLNW

REFERENCES



**LOLA 110**

DIMENSIONS CM

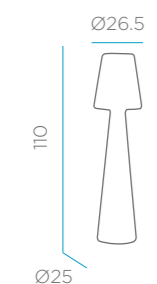

PACKAGING

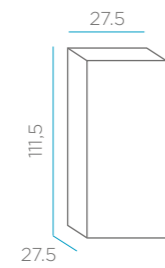

Weight: 3.5 kg

All finishes // Floor anchorage included.

Options

- Outdoor cable / white light\* \_\_\_\_\_ LUMLL110OFNW
- Indoor cable / warm light\* \_\_\_\_\_ LUMLL110ICNW
- Battery\* \_\_\_\_\_ LUMLL110TWLNW

REFERENCES



**FREDO 140** DIMENSIONS CM

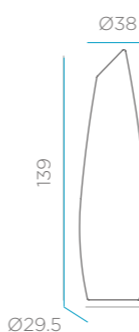

PACKAGING

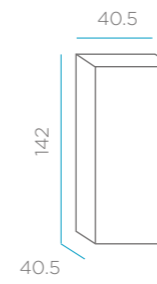

Weight: 5 kg

All finishes // Floor anchorage included.

Options

- Outdoor cable / white light\* \_\_\_\_\_ LUMFD140OFNW
- Battery\* \_\_\_\_\_ LUMFD140TWLNW

REFERENCES



**LOLA 165**

DIMENSIONS CM

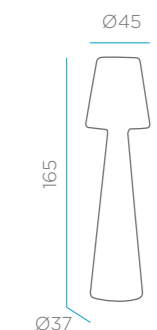

PACKAGING

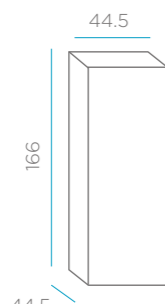

Weight: 10.5 kg

All finishes // Floor anchorage included.

Options

- Outdoor cable / white light\* \_\_\_\_\_ LUMLL165OFNW
- Indoor cable / warm light\* \_\_\_\_\_ LUMLL165ICNW
- Battery\* \_\_\_\_\_ LUMLL165TWLNW

REFERENCES



**FREDO 170** DIMENSIONS CM

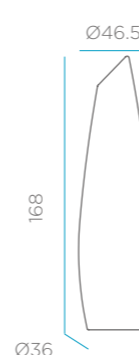

PACKAGING

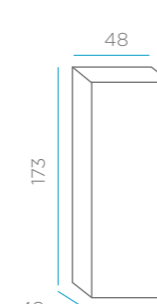

Weight: 7.5 kg

All finishes // Floor anchorage included.

Options

- Outdoor cable / white light\* \_\_\_\_\_ LUMFD170OFNW
- Indoor cable / warm light\* \_\_\_\_\_ LUMFD170ICNW
- Battery\* \_\_\_\_\_ LUMFD170TWLNW

REFERENCES



**KONIKA 170** DIMENSIONS CM PACKAGING REFERENCES

Options  
 Outdoor cable / white light \* \_\_\_\_\_ LUMKNI70OFNW   
 Battery\* \_\_\_\_\_ LUMKNI70TWLNW

Weight: 7,5 kg

All finishes // Floor anchorage included.

**LED TUBE**  
\*Supplied

**NORAI** DIMENSIONS CM PACKAGING REFERENCES

Options  
 Battery (Grey rope) \_\_\_\_\_ LUMNRO25WLNW   
 Battery (Pink rope) \_\_\_\_\_ LUMNRR025WLNW   
 Battery (Beige rope) \_\_\_\_\_ LUMNRB025WLNW

Weight: 1 Kg

**norai string**  
1,5 mt

**DECORATIVE**

**BOSSA NATURE** DIMENSIONS CM PACKAGING REFERENCES

Options  
 Battery \_\_\_\_\_ LUMBOHXNW

Weight: 1,5 Kg

**bossa string**  
3 mt

**STELLA** DIMENSIONS CM PACKAGING REFERENCES

Options  
 Outdoor cable / Warm light \_\_\_\_\_ LUMGSTLOCNW

Weight: 0,5 kg

**REONA NATURE** DIMENSIONS CM PACKAGING REFERENCES

Options  
 Battery \_\_\_\_\_ LUMREHXNW

Weight: 1,8 Kg

**reona string**  
3 mt

**ALLEGRA** DIMENSIONS CM PACKAGING REFERENCES

Options  
 Black / Outdoor cable / Warm light \_\_\_\_\_ LUMGALLOCNW   
 Black / Outdoor cable / RGB color \_\_\_\_\_ LUMGALLRGBNW   
 Pink / Outdoor cable / Warm light \_\_\_\_\_ LUMGALLOCRNW

Weight: 0,9 kg

**CALOBRA NATURE** DIMENSIONS CM PACKAGING REFERENCES

Options  
 Battery \_\_\_\_\_ LUMCAHXNW

Weight: 1,5 Kg

**calobra string**  
3 mt

**RUDY** DIMENSIONS CM PACKAGING REFERENCES

Options  
 Indoor cable / warm light\* \_\_\_\_\_ LUMRDO35ICNW   
 Smarttech (solar & rechargeable battery) \_\_\_\_\_ LUMRDO35SSNW

Weight: 1,4 kg

**\*BASE**  
Base E27 x 1 \*Supplied

**SISINE NATURE** DIMENSIONS CM PACKAGING REFERENCES

Options  
 Battery \_\_\_\_\_ LUMSIHXNW

Weight: 1,8 Kg

**sisine string**  
3 mt

**BALANS** DIMENSIONS CM PACKAGING REFERENCES

Options  
 Outdoor cable / white light \* \_\_\_\_\_ LUMBS070OFNW   
 Battery\* \_\_\_\_\_ LUMBS070TWLNW

Weight: 4,5 kg

**LED TUBE**  
\*Supplied

**BITA** DIMENSIONS CM PACKAGING REFERENCES

Options  
 Battery (space grey rope) \_\_\_\_\_ LUMBITAWLNW   
 Battery (Pink rope) \_\_\_\_\_ LUMBITAR030WLNW   
 Battery (Beige rope) \_\_\_\_\_ LUMBITAB030WLNW

Weight: 1 Kg

**bita string**  
1,5 mt

**GOA 40** DIMENSIONS CM PACKAGING REFERENCES

Options  
 Outdoor cable / white light \* \_\_\_\_\_ LUMGA040OFNW   
 Smarttech (solar & rechargeable battery) \_\_\_\_\_ LUMGA040SSNW

Weight: 1,5 kg

**\*BASE**  
Base E27 x 1 \*Supplied

**SORA** DIMENSIONS CM PACKAGING REFERENCES

Options  
 Battery (space grey rope) \_\_\_\_\_ LUMSORAWLNW   
 Battery (Pink rope) \_\_\_\_\_ LUMSORARWLNW   
 Battery (Beige rope) \_\_\_\_\_ LUMSORABWLNW

Weight: 1 Kg

**sora string**  
1,5 mt

**GOA 70** DIMENSIONS CM PACKAGING REFERENCES

Weight: 5,7 kg

**Options** } Outdoor cable / white light \* \_\_\_\_\_ LUMGA0700FNW   
 Battery\*\* \_\_\_\_\_ LUMGA070TWLNW

**\*BASE** Base E27 x 1 \*Supplied \*\*Supplied

**CANDELA** DIMENSIONS CM PACKAGING REFERENCES

Weight: 1,5 Kg

**Options** } Outdoor cable / white light \* \_\_\_\_\_ LUMCN0300FNW   
 Battery \_\_\_\_\_ LUMCN030WLNW

**\*BASE** Base E27 x 1 \*Supplied

**GUFO 40** DIMENSIONS CM PACKAGING REFERENCES

Weight: 2 kg

**Options** } Outdoor cable / white light \* \_\_\_\_\_ LUMGF0400FNW   
 Smarttech (solar & rechargeable battery) \_\_\_\_\_ LUMGF040SSNW

**\*BASE** Base E27 x 1 \*Supplied

**NÓMADA** DIMENSIONS CM PACKAGING REFERENCES

Weight: 1,2 Kg

**Options** } Solar & rechargeable battery \_\_\_\_\_ LUMNM032SLNW

**SAMBA** DIMENSIONS CM PACKAGING REFERENCES

Weight: 0,5 kg

**Options** } Lime / Indoor cable / warm light\* \_\_\_\_\_ LUMSMLV40ICNW   
 Indoor cable / warm light\* \_\_\_\_\_ LUMSMV40ICNW   
 Battery \_\_\_\_\_ LUMSM040WLNW

**\*BASE** Base E27 x 1 \*Supplied

**FARALAY** DIMENSIONS CM PACKAGING REFERENCES

Weight: 0,8 kg

**Options** } Smarttech (solar & rechargeable battery) \_\_\_\_\_ LUMFA033SSNW

**KAKTUS** DIMENSIONS CM PACKAGING REFERENCES

Weight: 3,2 kg

**Options** } Lime/ Outdoor cable / white light\* \_\_\_\_\_ LUMKLI000FNW \*Supplied  
 Outdoor cable / white light \* \_\_\_\_\_ LUMK1000FNW \*Supplied  
 Battery\* \_\_\_\_\_ LUMKLI00TWLNW

All finishes // Floor anchorage included.

**\*BASE** Base E27 x 1 \*Supplied

**KURBY** DIMENSIONS CM PACKAGING REFERENCES

Weight: 1,2 kg

**Options** } Smarttech (solar & rechargeable battery) \_\_\_\_\_ LUMKR038SSNW

**AMELIO** DIMENSIONS CM PACKAGING REFERENCES

Weight: 1,1 kg

**Options** } Indoor cable / warm light\* \_\_\_\_\_ LUMAM040ICNW   
 Smarttech (solar & rechargeable battery) \_\_\_\_\_ LUMAM040SSNW

**\*BASE** Base E27 x 1 \*Supplied

**TABLE LAMPS**

**ENOKI** DIMENSIONS CM PACKAGING REFERENCES

Weight: 1,2 Kg

**Options** } Battery white color \_\_\_\_\_ LUMEN025BWLNW   
 Battery black color \_\_\_\_\_ LUMEN025NWLNW   
 Battery pink color \_\_\_\_\_ LUMEN025RWLNW



**CHLOE 35** DIMENSIONS CM PACKAGING REFERENCES

Options

- Outdoor cable / warm light\* \_\_\_\_\_ LUMCHL035CCNW
- Smarttech (solar & rechargeable battery) \_\_\_\_\_ LUMCHL035SSNW

Weight: 1,8 kg

**LOLA 45** DIMENSIONS CM PACKAGING REFERENCES

Options

- Outdoor cable / white light\* \_\_\_\_\_ LUMLL045OFNW
- Indoor cable / warm light\* \_\_\_\_\_ LUMLL045ICNW
- Battery \_\_\_\_\_ LUMLL045WLNW

**\*BASE**

Base E27 x 1 \*Supplied

**LOLA SLIM 30** DIMENSIONS CM PACKAGING REFERENCES

Options

- Battery antracite color \_\_\_\_\_ LUMLLS030ANWLNW
- Battery plum color \_\_\_\_\_ LUMLLS030CIWLNW
- Battery lime color \_\_\_\_\_ LUMLLS030LIWLNW
- Battery banana color \_\_\_\_\_ LUMLLS030BAWLNW
- Battery raspberry color \_\_\_\_\_ LUMLLS030FRWLNW
- Battery mint color \_\_\_\_\_ LUMLLS030MNWLNW
- Battery brass color \_\_\_\_\_ LUMLLS030BRWLNW
- Battery rose gold color \_\_\_\_\_ LUMLLS030RGWLNW
- Battery space grey \_\_\_\_\_ LUMLLS030GEWLNW

Weight: 0,6 Kg

**CARMEN 45** DIMENSIONS CM PACKAGING REFERENCES

Options

- Outdoor cable / white light\* \_\_\_\_\_ LUMCR045OFNW
- Indoor cable / warm light\* \_\_\_\_\_ LUMCR045ICNW
- Battery \_\_\_\_\_ LUMCR045WLNW

**\*BASE**

Base E27 x 1 \*Supplied

**PANCHITO** DIMENSIONS CM PACKAGING REFERENCES

Options

- Lime / Battery \_\_\_\_\_ LUMPCT20VWLNW
- Battery warm light \_\_\_\_\_ LUMPCT20WWLNW

Weight: 0,4 Kg

**MAFALDA** DIMENSIONS CM PACKAGING REFERENCES

Options

- Indoor cable / warm light\* \_\_\_\_\_ LUMMF030ICNW
- Battery \_\_\_\_\_ LUMMF030WLNW

**\*BASE**

Base E27 x 1 \*Supplied

**ROCKET 20** DIMENSIONS CM PACKAGING REFERENCES

Options

- Battery warm light \_\_\_\_\_ LUMRCK20WLNW

Weight: 0,4 Kg

**FUNCTIONAL**

**PAQUITA 215 FAROLA** DIMENSIONS CM PACKAGING REFERENCES

Options

- Solar \_\_\_\_\_ LUMPQTFARSLNW

Weight: 12,8 kg

**LOLA 20** DIMENSIONS CM PACKAGING REFERENCES

Options

- Battery \_\_\_\_\_ LUMLL020WLNW
- AAA batteries\* \_\_\_\_\_ LUMLL20AAANW

\*no supplied

Weight: 0,3 Kg

**PAQUITA 40** DIMENSIONS CM PACKAGING REFERENCES

Options

- Solar \_\_\_\_\_ LUMPQTSMSLNW

Weight: 2,5 kg

**LOLA 30** DIMENSIONS CM PACKAGING REFERENCES

Options

- Outdoor cable / white light\* \_\_\_\_\_ LUMLL030OFNW
- Indoor cable / warm light\* \_\_\_\_\_ LUMLL030ICNW
- Battery \_\_\_\_\_ LUMLL030WLNW

**\*BASE**

Base E27 x 1 \*Supplied

Weight: 1,2 Kg

**PAQUITA WALL** DIMENSIONS CM PACKAGING REFERENCES

Options

- Solar \_\_\_\_\_ LUMPQTAPLSLNW

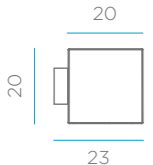

Weight: 1,9 kg

**CUBY 20 WALL**

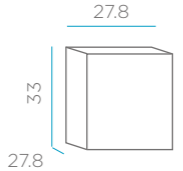
**DIMENSIONS CM**  

**PACKAGING**  
  
 Weight: 1,6 kg

**REFERENCES**  
**Options** Wall\* \_\_\_\_\_ LUMCB020OPNW

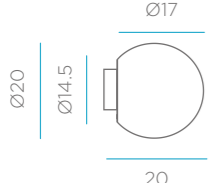

**\*BASE**  
 Base E27  x 1  Not supplied

**BULY 20 WALL**

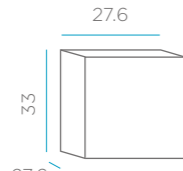
**DIMENSIONS CM**  

**PACKAGING**  
  
 Weight: 1 kg

**REFERENCES**  
**Options** Wall\* \_\_\_\_\_ LUMBLO200PNW

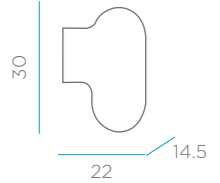

**\*BASE**  
 Base E27  x 1  Not supplied

**CÁPULA TERPE**

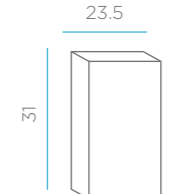
**DIMENSIONS CM**  

**PACKAGING**  
  
 Weight: 1,6 kg

**REFERENCES**  
**Options** Wall\* \_\_\_\_\_ LUMCP030OPNW

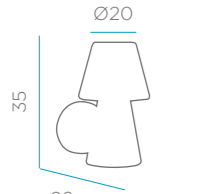

**\*BASE**  
 Base E27  x 1  Not supplied

**LOLA WALL**

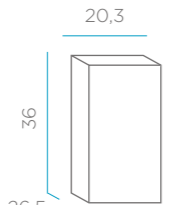
**DIMENSIONS CM**  

**PACKAGING**  
  
 Weight: 1,6 kg

**REFERENCES**  
**Options** Wall\* \_\_\_\_\_ LUMLL035OPNW

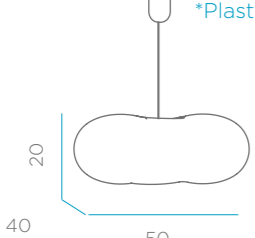

**\*BASE**  
 Base E27  x 1  Not supplied

**CLAUDY HANG**

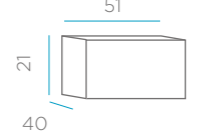
**DIMENSIONS CM**  
  
 \*Plastic trim

**PACKAGING**  
  
 Weight: 2,3 kg

**REFERENCES**  
**Options** Hang white color \_\_\_\_\_ LUMCL050HXNW ○  
 Hang soft pink \_\_\_\_\_ LUMCLR50HXNW ●  
 Hang soft blue \_\_\_\_\_ LUMCLA50HXNW ●



**BASE**  
 Base E27  x 1  Not supplied

**BALBY HANG**

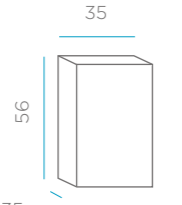
**DIMENSIONS CM**  
  
 \*Metal trim

**PACKAGING**  
  
 Weight: 2,5 kg

**REFERENCES**  
**Options** Hang \_\_\_\_\_ LUMBBO30HXNW

**BASE**  
 Base E27  x 1  Not supplied

**BULY 30 HANG**

**DIMENSIONS CM**  
  
 \*Metal trim

**PACKAGING**  
  
 Weight: 1,6 kg

**REFERENCES**  
**Options** Hang \_\_\_\_\_ LUMBLO30HXNW



**BASE**  
 Base E27  x 1  Not supplied

**PETRA 40 HANG**

**DIMENSIONS CM**  
  
 \*Metal trim

**PACKAGING**  
  
 Weight: 1,5 kg

**REFERENCES**  
**Options** Hang \_\_\_\_\_ LUMPT040HXNW

**BASE**  
 Base E27  x 1  Not supplied

**PETRA 60 HANG**

**DIMENSIONS CM**  
  
 \*Metal trim

**PACKAGING**  
  
 Weight: 3,2 kg

**REFERENCE**  
**Options** Hang \_\_\_\_\_ LUMPT060HXNW

**BASE**  
 Base E27  x 1  Not supplied

## ESSENTIALS

**BULY 20**

**DIMENSIONS CM**  



**PACKAGING**  
  
 Weight: 0,8 kg



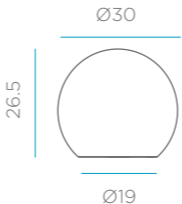

**REFERENCES**  
**Options** Outdoor cable / white light \* \_\_\_\_\_ LUMBLO200FNW   
 Smarttech (solar & rechargeable battery) \_\_\_\_\_ LUMBLO20SSNW 

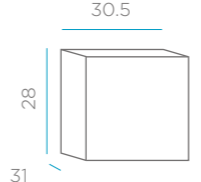

**\*BASE**  
 Base E27  x 1  \*Supplied

**BULY 30**

**DIMENSIONS CM**  

**PACKAGING**  
  
 Weight: 1,2 kg

**REFERENCES**  
**Options** Outdoor cable / white light \* \_\_\_\_\_ LUMBLO300FNW   
 Smarttech (solar & rechargeable battery) \_\_\_\_\_ LUMBLO30SSNW   
 Smarttech Floating (solar & rechargeable battery) \_\_\_\_\_ LUMBLO30FTNW   
 Outdoor white granite\* \_\_\_\_\_ LUMBLG300FNW 

**\*BASE**  
 Base E27  x 1  \*Supplied

**BULY 40** DIMENSIONS CM PACKAGING REFERENCES

**Options**

- Outdoor cable / white light \* \_\_\_\_\_ LUMBL040OFNW
- Smarttech (solar & rechargeable battery) \_\_\_\_\_ LUMBL040SSNW
- Smarttech Floating (solar & rechargeable battery) \_\_\_\_\_ LUMBL040FTNW

**\*BASE**

Base E27 x 1 \*Supplied

**CUBY 32** DIMENSIONS CM PACKAGING REFERENCES

**Options**

- Outdoor cable / white light \* \_\_\_\_\_ LUMCB032OFNW
- Smarttech (solar & rechargeable battery) \_\_\_\_\_ LUMCB032SSNW

**\*BASE**

Base E27 x 1 \*Supplied

**BULY 50** DIMENSIONS CM PACKAGING REFERENCES

**Options**

- Outdoor cable / white light \* \_\_\_\_\_ LUMBL050OFNW
- Smarttech (solar & rechargeable battery) \_\_\_\_\_ LUMBL050SSNW

**\*BASE**

Base E27 x 1 \*Supplied

**CUBY 45** DIMENSIONS CM PACKAGING REFERENCES

**Options**

- Outdoor cable / white light \* \_\_\_\_\_ LUMCB045OFNW
- Smarttech (solar & rechargeable battery) \_\_\_\_\_ LUMCB045SSNW

**\*BASE**

Base E27 x 1 \*Supplied

**BULY 60** DIMENSIONS CM PACKAGING REFERENCES

**Options**

- Outdoor cable / white light \* \_\_\_\_\_ LUMBL060OFNW
- Smarttech (solar & rechargeable battery) \_\_\_\_\_ LUMBL060SSNW

**\*BASE**

Base E27 x 1 \*Supplied

**CUBY 53** DIMENSIONS CM PACKAGING REFERENCES

**Options**

- Outdoor cable / white light \* \_\_\_\_\_ LUMCB053OFNW
- Smarttech (solar & rechargeable battery) \_\_\_\_\_ LUMCB053SSNW

**\*BASE**

Base E27 x 1 \*Supplied

**BULY 80** DIMENSIONS CM PACKAGING REFERENCES

**Options**

- Outdoor cable / white light \* \_\_\_\_\_ LUMBL080OFNW
- Smarttech (solar & rechargeable battery) \_\_\_\_\_ LUMBL080SSNW

**\*BASE**

Base E27 x 1 \*Supplied

**PETRA 40** DIMENSIONS CM PACKAGING REFERENCES

**Options**

- Outdoor cable / white light \* \_\_\_\_\_ LUMPT040OFNW
- Smarttech (solar & rechargeable battery) \_\_\_\_\_ LUMPT040SSNW

**\*BASE**

Base E27 x 1 \*Supplied

**CUBY 20** DIMENSIONS CM PACKAGING REFERENCES

**Options**

- Outdoor cable / white light \* \_\_\_\_\_ LUMCB020OFNW
- Smarttech (solar & rechargeable battery) \_\_\_\_\_ LUMCB020SSNW

**\*BASE**

Base E27 x 1 \*Supplied

**PETRA 60** DIMENSIONS CM PACKAGING REFERENCES

**Options**

- Outdoor cable / white light \* \_\_\_\_\_ LUMPT060OFNW
- Smarttech (solar & rechargeable battery) \_\_\_\_\_ LUMPT060SSNW

**\*BASE**

Base E27 x 1 \*Supplied

## SPEAKERS

**PIPA** DIMENSIONS CM PACKAGING REFERENCES

Options: Play light&music LUMPP035PLNW x 1

Weight: 1,3 kg

**NIPPER** DIMENSIONS CM PACKAGING REFERENCES

Options: Play light&music LUMNP040PLNW x 1

Weight: 1,5 kg

**ROBIN PLAY** DIMENSIONS CM PACKAGING REFERENCES

Options: Play light&music MOBRB035PLNW x 2

Weight: 2,5 kg

**FARALAY PLAY** DIMENSIONS CM PACKAGING REFERENCES

Options: Play light&music LUMFA033PLNW x 1

Weight: 1,8 kg

**NÓMADA PLAY** DIMENSIONS CM PACKAGING REFERENCES

Options: Play light&music LUMNM032PLNW x 1

Weight: 1,5 Kg

**KURBY PLAY** DIMENSIONS CM PACKAGING REFERENCES

Options: Play light&music LUMKR038PLNW x 1

Weight: 1,2 kg

**CUBY 20 PLAY** DIMENSIONS CM PACKAGING REFERENCES

Options: Play light&music LUMCBP20WLNW x 1

Weight: 1,1 Kg

**CUBY 32 PLAY** DIMENSIONS CM PACKAGING REFERENCES

Options: Play light&music LUMCBP32WLNW x 2

Weight: 3,1 Kg

**CUBY 45 PLAY** DIMENSIONS CM PACKAGING REFERENCES

Options: Play light&music LUMCBP45WLNW x 2

Weight: 5,35 Kg

## CHRISTMAS

**PINUS 40** DIMENSIONS CM PACKAGING REFERENCES

Options: Green / Indoor cable / warm light\* LUMPNO40ICNW   
 Indoor cable / warm light\* LUMPNO40ICNW   
 Smarttech (solar & rechargeable battery) LUMPNO40SSNW

\*BASE Base E27 x 1 \*Supplied

Weight: 1,3 kg

**PINUS 100** DIMENSIONS CM

PACKAGING

REFERENCES

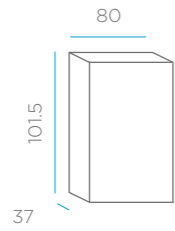
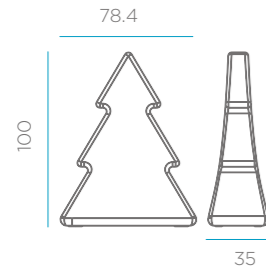

Weight: 5,5 kg

- Options**
- Outdoor cable / white light\* \_\_\_\_\_ LUMPN1000FNW
  - Indoor cable / warm light\* \_\_\_\_\_ LUMPN100ICNW
  - Green / Indoor cable / white light\* \_\_\_\_\_ LUMPNV100ICNW
  - Battery\* \_\_\_\_\_ LUMPN100TWNW



**NOVA 60** DIMENSIONS CM

PACKAGING

REFERENCES

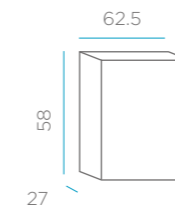
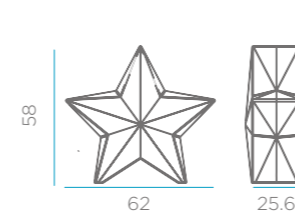

Weight: 3,2 kg

- Options**
- Outdoor cable / white light\*\* \_\_\_\_\_ LUMNV0600FNW
  - Indoor cable / warm light\* \_\_\_\_\_ LUMNV060ICNW
  - Battery\* \_\_\_\_\_ LUMNV060TWNW

**\*BASE**

Base E27



x 1

\*Supplied



**PINUS 160** DIMENSIONS CM

PACKAGING

REFERENCES

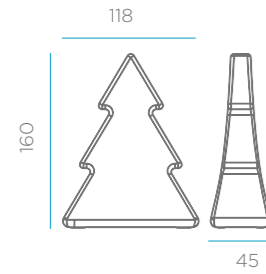

Plastic bag  
Weight: 14 kg

- Options**
- Outdoor cable / white light\* \_\_\_\_\_ LUMPN1600FNW
  - Outdoor cable / warm light\* \_\_\_\_\_ LUMPN1600CNW
  - Green outdoor white\* \_\_\_\_\_ LUMPNV1600FNW
  - Battery\* \_\_\_\_\_ LUMPN160TWNW



**KLAUS** DIMENSIONS CM

PACKAGING

REFERENCES

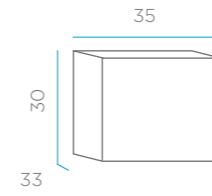
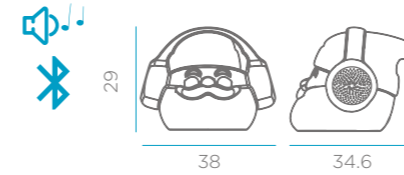

Weight: 1,8 kg

- Options**
- Play light&music \_\_\_\_\_ LUMKS030PLNW



**SNOWY 40** DIMENSIONS CM

PACKAGING

REFERENCES

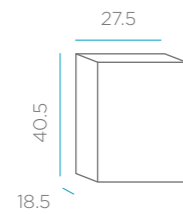
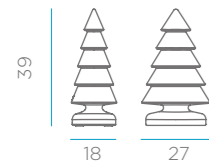

Weight: 1,6 kg

- Options**
- Indoor cable / warm light\* \_\_\_\_\_ LUMSN040ICNW
  - Battery \_\_\_\_\_ LUMSN040WLNW

**\*BASE**

Base E27



x 1

\*Supplied

**SNOWY 100** DIMENSIONS CM

PACKAGING

REFERENCES

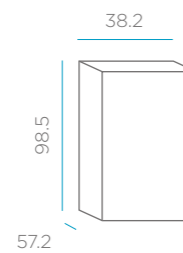
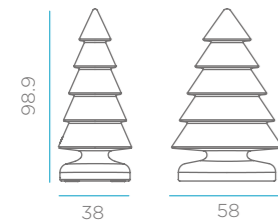

Weight: 5,1 kg

- Options**
- Outdoor cable / white light\* \_\_\_\_\_ LUMSN1000FNW
  - Battery\* \_\_\_\_\_ LUMSN100TWNW



**FURNITURE**

**TABLES**

**BAHAMA** DIMENSIONS CM

PACKAGING

REFERENCES

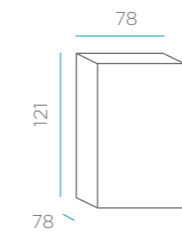
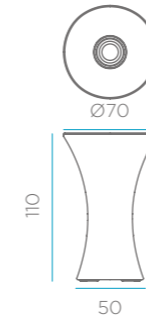

Weight: 10,5 kg

Methacrylate cover included

- Options**
- Battery\* \_\_\_\_\_ MOB BH110TWNW
  - White color \_\_\_\_\_ LUMBH110BXNW



**CAPRI 40** DIMENSIONS CM

PACKAGING

REFERENCES

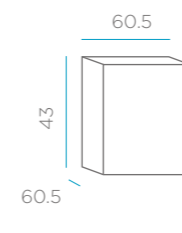

Weight: 4,5 kg

Methacrylate cover included

- Options**
- Smarttech (solar & rechargeable battery) MOB CP040SSNW
  - White color \_\_\_\_\_ MOB CP040BXNW
  - Bronze color \_\_\_\_\_ MOB CP040ZXNW
  - Topo color \_\_\_\_\_ MOB CP040KXNW
  - Black color \_\_\_\_\_ MOB CP040NXNW



**NOVA 45** DIMENSIONS CM

PACKAGING

REFERENCES

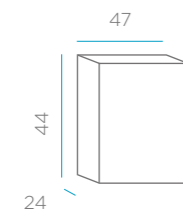
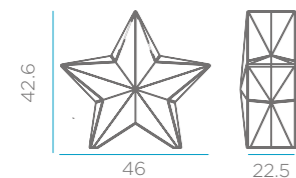

Weight: 1,9 kg

- Options**
- Indoor cable / warm light\* \_\_\_\_\_ LUMNV045ICNW
  - Smarttech (solar & rechargeable battery) \_\_\_\_\_ LUMNV045SSNW

**\*BASE**

Base E27



x 1

\*Supplied

**CAPRI 75** DIMENSIONS CM

PACKAGING

REFERENCES

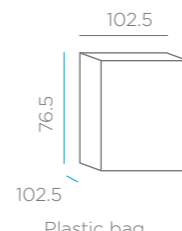
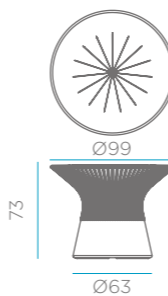

Plastic bag

Weight: 18 kg

Methacrylate cover included

- Options**
- Smarttech (solar & rechargeable battery) MOB CP075SSNW
  - Outdoor cable / white light\* \_\_\_\_\_ MOB CP0750FNW
  - White color \_\_\_\_\_ MOB CP075BXNW
  - Bronze color \_\_\_\_\_ MOB CP075ZXNW
  - Topo color \_\_\_\_\_ MOB CP075KXNW

**\*BASE**

Base E27



x 1

\*Supplied



**CAPRI 110** DIMENSIONS CM PACKAGING REFERENCES

Options

- Battery\* \_\_\_\_\_ MOBCEP110TWNW
- Outdoor cable / white light \*\* \_\_\_\_\_ MOBCEP110OFNW
- White color \_\_\_\_\_ MOBCEP110BXNW
- Bronze color \_\_\_\_\_ MOBCEP110ZXNW
- Topo color \_\_\_\_\_ MOBCEP110KXNW

Weight: 10 kg  
Methacrylate cover included

\*BASE  
Base E27 x 1 \*Supplied

LED TUBE \*Supplied

**BORA** DIMENSIONS CM PACKAGING REFERENCES

Options

- Outdoor cable / white light\* / Wood \_\_\_\_\_ LUMBORAMBXINOUTNW
- Outdoor cable / white light\* / Marble \_\_\_\_\_ LUMBORAWXINOUTNW
- White color marble \_\_\_\_\_ LUMBORAMBXNW
- White color wood \_\_\_\_\_ LUMBORAWBXNW

Weight: 8,75 kg

\*BASE  
Base E27 x 1 \*Supplied HEMP cable

**MELVIN** DIMENSIONS CM PACKAGING REFERENCES

Options

- Smarttech (solar & rechargeable battery) \_\_\_\_\_ MOBMOV05SSNW
- White color \_\_\_\_\_ MOBMOV05BXNW
- Bronze color \_\_\_\_\_ MOBMOV05ZXNW
- Topo color \_\_\_\_\_ MOBIMV05KXNW

Weight: 6 kg  
Methacrylate cover included

**CUBY 45** DIMENSIONS CM PACKAGING REFERENCES

Options

- Outdoor cable / white light\* \_\_\_\_\_ LUMCB045OFNW
- Smarttech (solar & rechargeable battery) \_\_\_\_\_ LUMCB045SSNW

Weight: 5 kg

\*BASE  
Base E27 x 1 \*Supplied

**MARTINICA NEW ISLAND** DIMENSIONS CM PACKAGING REFERENCES

Options

- Smarttech (solar & rechargeable) \_\_\_\_\_ MOBMESMASSNW
- White color \_\_\_\_\_ MOBMESMABXNW
- Bronze color \_\_\_\_\_ MOBMESMAZXNW
- Topo color \_\_\_\_\_ MOBIMESMAKXNW

Plastic bag  
Weight: 10 kg

**CUBY 53** DIMENSIONS CM PACKAGING REFERENCES

Options

- Outdoor cable / white light\* \_\_\_\_\_ LUMCB053OFNW
- Smarttech (solar & rechargeable battery) \_\_\_\_\_ LUMCB053SSNW

Weight: 5,5 kg

\*BASE  
Base E27 x 1 \*Supplied

**TARIDA TAB** DIMENSIONS CM PACKAGING REFERENCES

Options

- Play light&music \_\_\_\_\_ MOBTDT30PLNW
- Smarttech (solar & rechargeable) \_\_\_\_\_ MOBTDT30SSNW
- White color \_\_\_\_\_ MOBTDT30BXNW
- Bronze color \_\_\_\_\_ MOBTDT30ZXNW
- Topo color \_\_\_\_\_ MOBTDT30KXNW

Weight: 5 kg  
Methacrylate cover included

**CUBY 53 PLAY** DIMENSIONS CM PACKAGING REFERENCES

Options

- Play light&music \_\_\_\_\_ LUMCBP55WLNW

Weight: 5,5 kg

**ITACA** DIMENSIONS CM PACKAGING REFERENCES

Options

- Smarttech (solar & rechargeable) \_\_\_\_\_ MOBIC60SSNW
- White color \_\_\_\_\_ MOBIC60BXNW
- Bronze color \_\_\_\_\_ MOBIC60CXNW
- Topo color \_\_\_\_\_ MOBIC60CKXNW

Weight: 14 kg  
Phenolic cover included. Unassembled  
Weight stability included  
Individual package. tabletop plastic bag

# SEATS

**RASA** DIMENSIONS CM PACKAGING REFERENCES



Options

- White color \_\_\_\_\_ MOBRSABXNW ○

Weight: 15 kg

**FORMENTERA** DIMENSIONS CM PACKAGING REFERENCES



Options

- Smarttech (solar & rechargeable battery) \_\_\_\_\_ MOBFR160SSNW
- Outdoor cable / white light \* \_\_\_\_\_ MOBFR160OFNW
- White color \_\_\_\_\_ MOBFR160BXNW ○
- Topo color \_\_\_\_\_ MOBFR160KXNW ●

Plastic bag

Weight: 42kg

\*Conformentera not included

**\*BASE**

Base E27 x 2 \*Supplied

**ARUBA NEW ISLAND** DIMENSIONS CM PACKAGING REFERENCES



Options

- Smarttech (solar & rechargeable battery) \_\_\_\_\_ MOBSILARSSNW
- White color \_\_\_\_\_ MOBSILARBXNW ○
- Bronze color \_\_\_\_\_ MOBSILARZXNW ●
- Topo color \_\_\_\_\_ MOBSILARKXNW ●

Plastic bag

Weight: 11,5 kg

**JAMAICA NEW ISLAND** DIMENSIONS CM PACKAGING REFERENCES

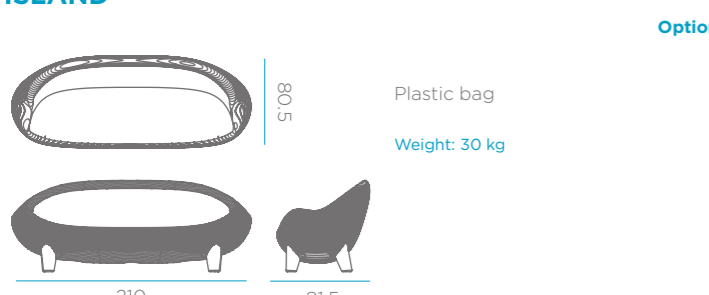

Options

- Smarttech (solar & rechargeable battery) \_\_\_\_\_ MOBSOFJASSNW
- Outdoor cable / white light \* \_\_\_\_\_ MOBSOFJAOFNW
- White color \_\_\_\_\_ MOBSOFJABXNW ○
- Bronze color \_\_\_\_\_ MOBSOFJAZXNW ●
- Topo color \_\_\_\_\_ MOBSOFJAKXNW ●

Plastic bag

Weight: 30 kg

**\*BASE**

Base E27 x 1 \*Supplied

**TARIDA SIT ARMS** DIMENSIONS CM PACKAGING REFERENCES

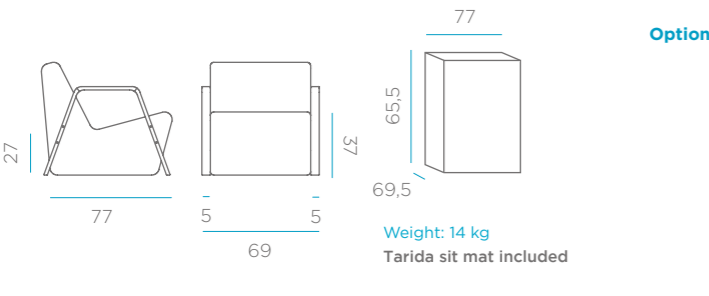

Options

- Smarttech (solar & rechargeable battery) \_\_\_\_\_ MOBTD66ARMSSNW
- White color \_\_\_\_\_ MOBTD66ARMBXNW ○

Weight: 14 kg

Tarida sit mat included

**TARIDA SIT** DIMENSIONS CM PACKAGING REFERENCES

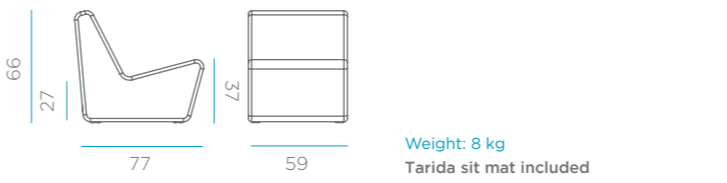

Options

- Smarttech (solar & rechargeable battery) \_\_\_\_\_ MOBTD66SSNW
- White color \_\_\_\_\_ MOBTD66BXNW ○
- Bronze color \_\_\_\_\_ MOBTD66ZXNW ●
- Topo color \_\_\_\_\_ MOBTD66KXNW ●
- Soft pink color \_\_\_\_\_ MOBTD66RSNW ●

Weight: 8 kg

Tarida sit mat included

**MALLORCA** DIMENSIONS CM PACKAGING REFERENCES

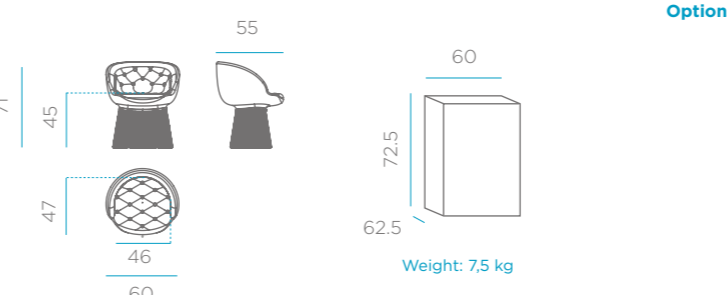

Options

- Smarttech (solar & rechargeable battery) \_\_\_\_\_ MOBMA060SSNW
- White color \_\_\_\_\_ MOBMA060BXNW ○
- Bronze color \_\_\_\_\_ MOBMA060ZXNW ●
- Topo color \_\_\_\_\_ MOBMA060KXNW ●

Weight: 7,5 kg

**MENORCA BENCH** DIMENSIONS CM PACKAGING REFERENCES

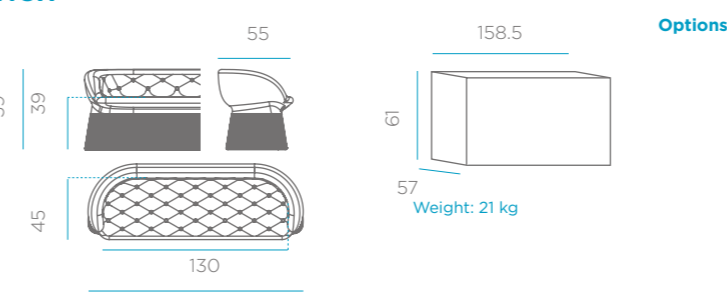

Options

- Smarttech (solar & rechargeable battery) \_\_\_\_\_ MOBME150SSNW
- Outdoor cable / white light \* \_\_\_\_\_ MOBME150OFNW
- White color \_\_\_\_\_ MOBME150BXNW ○
- Bronze color \_\_\_\_\_ MOBME150ZXNW ●
- Topo color \_\_\_\_\_ MOBME150KXNW ●

Weight: 21 kg

**\*BASE**

Base E27 x 2 \*Supplied

**MENORCA SOFA** DIMENSIONS CM PACKAGING REFERENCES

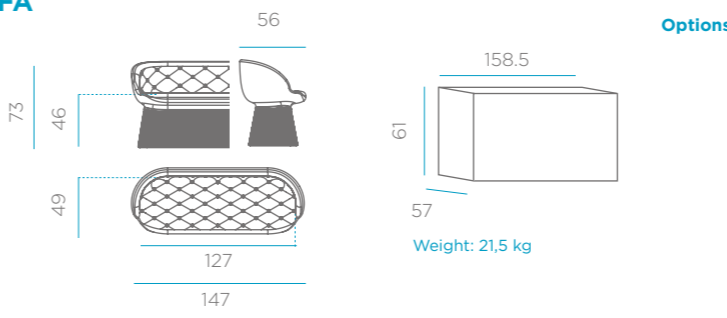

Options

- Smarttech (solar & rechargeable battery) \_\_\_\_\_ MOBMS150SSNW
- Outdoor cable / white light \* \_\_\_\_\_ MOBMS150OFNW
- White color \_\_\_\_\_ MOBMS150BXNW ○
- Bronze color \_\_\_\_\_ MOBMS150ZXNW ●
- Topo color \_\_\_\_\_ MOBMS150KXNW ●

Weight: 21,5 kg

**\*BASE**

Base E27 x 2 \*Supplied

**CALVIN** DIMENSIONS CM PACKAGING REFERENCES

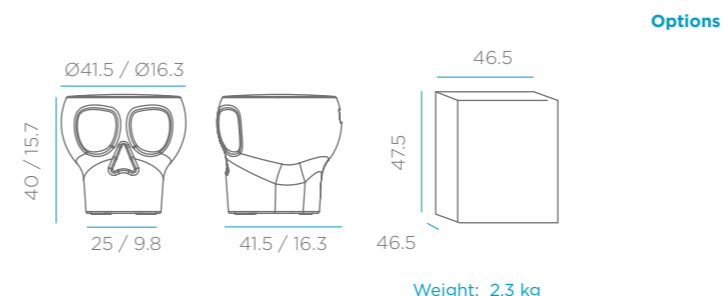

Options

- Smarttech (solar & rechargeable battery) \_\_\_\_\_ MOBVC040SSNW
- Play light&music \_\_\_\_\_ MOBVC040PLNW
- White color \_\_\_\_\_ MOBVC040BXNW ○
- Bronze color \_\_\_\_\_ MOBVC040ZXNW ●
- Topo color \_\_\_\_\_ MOBVC040KXNW ●

Weight: 2,3 kg

**CORFU 40** DIMENSIONS CM PACKAGING REFERENCES

**Options**

- Smarttech (solar & rechargeable battery) \_\_\_\_\_ MOBCF040SSNW
- White color \_\_\_\_\_ MOBCF040BXNW
- Bronze color \_\_\_\_\_ MOBCF040ZXNW
- Topo color \_\_\_\_\_ MOBCF040KXNW

**SICILIA 75** DIMENSIONS CM PACKAGING REFERENCES

**Options**

- Smarttech (solar & rechargeable battery) \_\_\_\_\_ MOBSC075SSNW
- Outdoor cable / white light \* \_\_\_\_\_ MOBSC075OFNW
- White color \_\_\_\_\_ MOBSC075BXNW

**\*BASE**

Base E27 x 1 \*Supplied

**CORFU 74** DIMENSIONS CM PACKAGING REFERENCES

**Options**

- Smarttech (solar & rechargeable battery) \_\_\_\_\_ MOBCF074SSNW
- White color \_\_\_\_\_ MOBCF074BXNW
- Bronze color \_\_\_\_\_ MOBCF074ZXNW
- Topo color \_\_\_\_\_ MOBCF074KXNW

**SICILIA 120** DIMENSIONS CM PACKAGING REFERENCES

**Options**

- Smarttech (solar & rechargeable battery) \_\_\_\_\_ MOBSC120SSNW
- Outdoor cable / white light \* \_\_\_\_\_ MOBSC120OFNW
- White color \_\_\_\_\_ MOBSC120BXNW

**\*BASE**

Base E27 x 2 \*Supplied

**PUFY** DIMENSIONS CM PACKAGING REFERENCES

**Options**

- White color \_\_\_\_\_ MOBPF045BXNW
- Bronze color \_\_\_\_\_ MOBPF045ZXNW
- Topo color \_\_\_\_\_ MOBPF045KXNW

**IBIZA** DIMENSIONS CM PACKAGING REFERENCES

**Options**

- Smarttech (solar & rechargeable battery) \_\_\_\_\_ MOBBI20SSNW
- Outdoor cable / white light \* \_\_\_\_\_ MOBBI20OFNW
- White color \_\_\_\_\_ MOBBI20BXNW

**\*BASE**

Base E27 x 2 \*Supplied

Methacrylate cover included

**TAFY 38** DIMENSIONS CM PACKAGING REFERENCES

**Options**

- White color \_\_\_\_\_ MOBTF038BXNW
- Black color \_\_\_\_\_ MOBTF038NXNW
- Bronze color \_\_\_\_\_ MOBTF038ZXNW
- Topo color \_\_\_\_\_ MOBTF038KXNW
- Grey color \_\_\_\_\_ MOBTF038SXNW

**CRETA** DIMENSIONS CM PACKAGING REFERENCES

**Options**

- Smarttech (solar & rechargeable battery) \_\_\_\_\_ MOBRC120SSNW
- Outdoor cable / white light \* \_\_\_\_\_ MOBRC120OFNW
- White color \_\_\_\_\_ MOBRC120BXNW

**CRETA ACCESSORY**

101,5  
12  
21

**REFERENCES**

E01MT0041

**\*BASE**

Base E27 x 2 \*Supplied

Methacrylate cover included

**BAR**

**BRICKY** DIMENSIONS CM PACKAGING REFERENCES

**Options**

- Cable RGBW \_\_\_\_\_ MOBRR45ORGBWNW
- White color \_\_\_\_\_ MOBRR045BXNW
- Soft pink color \_\_\_\_\_ MOBRR045RSNW
- Bronze color \_\_\_\_\_ MOBRR045ZXNW
- Topo color \_\_\_\_\_ MOBRR045KXNW

**PALMA BOTTLE RACK** DIMENSIONS CM PACKAGING REFERENCES

**Options**

- Outdoor cable / white light \* \_\_\_\_\_ LUMPMB70OFNW
- Smarttech (solar & rechargeable battery) \_\_\_\_\_ LUMPMB70SSNW

**\*BASE**

Base E27 x 1 \*Supplied

9L  
Aluminium ice bucket Cooler accessory



## WOODY

### DIMENSIONS CM

### PACKAGING

### REFERENCES

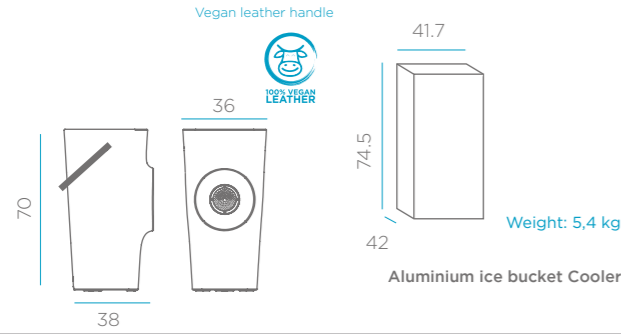

#### Options

- Play light&music \_\_\_\_\_ LUMWD070PLNW x 1
- Smarttech (solar & rechargeable battery) \_\_\_\_\_ LUMWD070SSNW
- Outdoor cable / white light \* \_\_\_\_\_ LUMWD070OFNW

#### \*BASE

- Base E27 x 1 \*Supplied

## COOLER

### DIMENSIONS CM

### PACKAGING

### REFERENCES

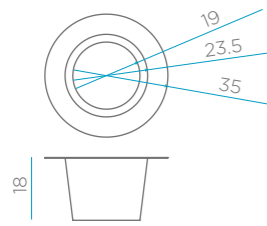

Plastic bag

#### Options

- Cooler bambu \_\_\_\_\_ MP00978
- Cooler palma \_\_\_\_\_ MP00979

## FLOWERPOTS

## BAMBÚ 70

### DIMENSIONS CM

### PACKAGING

### REFERENCES

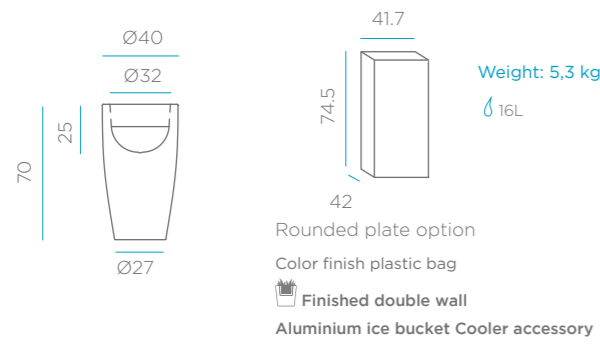

#### Options

- Smarttech (solar & rechargeable battery) \_\_\_\_\_ LUMB070SSNW
- Outdoor cable / white light\* \_\_\_\_\_ LUMB070OFNW
- White color \_\_\_\_\_ JDNBM070BXNW
- Black color \_\_\_\_\_ JDNBM070NXNW
- Bronze color \_\_\_\_\_ JDNBM070ZXNW
- Topo color \_\_\_\_\_ JDNBM070KXNW
- Grey color \_\_\_\_\_ JDNBM070SXNW
- Terracota color \_\_\_\_\_ JDNBM070TXNW
- Soft pink color \_\_\_\_\_ JDNBM070RXNW
- Soft blue color \_\_\_\_\_ JDNBM070AXNW
- Soft green color \_\_\_\_\_ JDNBM070VXNW

#### \*BASE

- Base E27 x 1 \*Supplied

## BAMBÚ 90

### DIMENSIONS CM

### PACKAGING

### REFERENCES

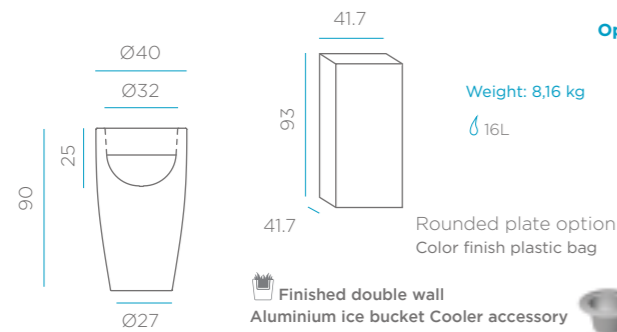

#### Options

- Battery\* \_\_\_\_\_ LUMB090TWLNW
- Outdoor cable / white light\*\* \_\_\_\_\_ LUMB090OFNW
- White color \_\_\_\_\_ JDNBM090BXNW
- Black color \_\_\_\_\_ JDNBM090NXNW
- Bronze color \_\_\_\_\_ JDNBM090ZXNW
- Topo color \_\_\_\_\_ JDNBM090KXNW
- Grey color \_\_\_\_\_ JDNBM090SXNW
- Terracota color \_\_\_\_\_ JDNBM090TXNW

#### \*BASE

- Base E27 x 1 \*\*Supplied



## CAMELIA 40

### DIMENSIONS CM

### PACKAGING

### REFERENCES

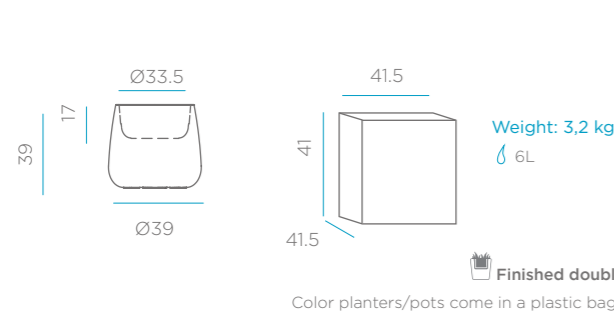

#### Options

- Smarttech (solar & rechargeable battery) \_\_\_\_\_ LUMCA040SSNW
- Outdoor cable / white light\* \_\_\_\_\_ LUMCA040OFNW
- White color \_\_\_\_\_ LUMCA040BXNW
- Black color \_\_\_\_\_ LUMCA040NXNW
- Bronze color \_\_\_\_\_ LUMCA040ZXNW
- Topo color \_\_\_\_\_ LUMCA040KXNW
- Grey color \_\_\_\_\_ LUMCA040SXNW
- Terracota color \_\_\_\_\_ LUMCA040TXNW
- Soft pink color \_\_\_\_\_ LUMCA040RXNW
- Soft blue color \_\_\_\_\_ LUMCA040AXNW
- Soft green color \_\_\_\_\_ LUMCA040VXNW

#### \*BASE

- Base E27 x 1 \*Supplied

## CAMELIA 60

### DIMENSIONS CM

### PACKAGING

### REFERENCES

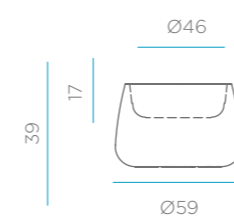

#### Options

- Smarttech (solar & rechargeable battery) \_\_\_\_\_ LUMCA060SSNW
- Outdoor cable / white light\* \_\_\_\_\_ LUMCA060OFNW
- White color \_\_\_\_\_ JDNCA060BXNW
- Black color \_\_\_\_\_ JDNCA060NXNW
- Bronze color \_\_\_\_\_ JDNCA060ZXNW
- Topo color \_\_\_\_\_ JDNCA060KXNW
- Grey color \_\_\_\_\_ JDNCA060SXNW
- Terracota color \_\_\_\_\_ JDNCA060TXNW

#### \*BASE

- Base E27 x 1 \*Supplied

## CAMELIA 80

### DIMENSIONS CM

### PACKAGING

### REFERENCES

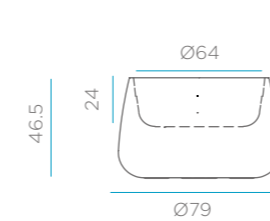

#### Options

- Smarttech (solar & rechargeable battery) \_\_\_\_\_ LUMCA080SSNW
- Outdoor cable / white light\* \_\_\_\_\_ LUMCA080OFNW
- White color \_\_\_\_\_ JDNCA080BXNW
- Black color \_\_\_\_\_ JDNCA080NXNW
- Bronze color \_\_\_\_\_ JDNCA080ZXNW
- Topo color \_\_\_\_\_ JDNCA080KXNW
- Grey color \_\_\_\_\_ JDNCA080SXNW
- Terracota color \_\_\_\_\_ JDNCA080TXNW

#### \*BASE

- Base E27 x 1 \*Supplied

## CAMELIA LARGE

### DIMENSIONS CM

### PACKAGING

### REFERENCES

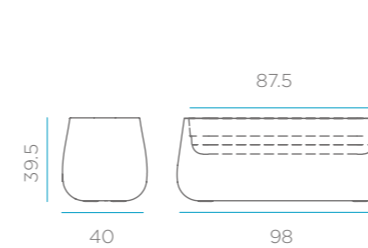

#### Options

- Smarttech (solar & rechargeable battery) \_\_\_\_\_ LUMCALARSSNW
- Outdoor cable / white light\* \_\_\_\_\_ LUMCALAROFNW
- White color \_\_\_\_\_ JDNCALARBXNW
- Black color \_\_\_\_\_ JDNCALARNXNW
- Bronze color \_\_\_\_\_ JDNCALARZXNW
- Topo color \_\_\_\_\_ JDNCALARKXNW
- Grey color \_\_\_\_\_ JDNCALARSXNW
- Terracota color \_\_\_\_\_ JDNCALARTXNW

#### \*BASE

- Base E27 x 1 \*Supplied

## CAMELIA HIGH

### DIMENSIONS CM

### PACKAGING

### REFERENCES

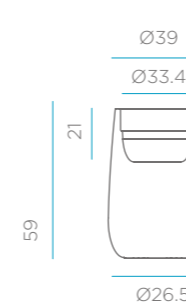

#### Options

- Smarttech (solar & rechargeable battery) \_\_\_\_\_ LUMCAHIGSSNW
- Outdoor cable / white light\* \_\_\_\_\_ LUMCAHIGOFNW
- White color \_\_\_\_\_ JDNCAHIGBXNW
- Black color \_\_\_\_\_ JDNCAHIGNXNW
- Bronze color \_\_\_\_\_ JDNCAHIGZXNW
- Topo color \_\_\_\_\_ JDNCAHIGKXNW
- Grey color \_\_\_\_\_ JDNCAHIGSXNW
- Terracota color \_\_\_\_\_ JDNCAHIGTXNW
- Soft pink color \_\_\_\_\_ JDNCAHIGRXNW
- Soft blue color \_\_\_\_\_ JDNCAHIGAXNW
- Soft green color \_\_\_\_\_ JDNCAHIGVXNW

#### \*BASE

- Base E27 x 1 \*Supplied

## FIGUS 60

### DIMENSIONS CM

### PACKAGING

### REFERENCES

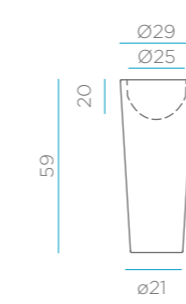

#### Options

- Smarttech (solar & rechargeable battery) \_\_\_\_\_ LUMFC060SSNW
- Outdoor cable / white light\* \_\_\_\_\_ LUMFC060OFNW
- White color \_\_\_\_\_ LUMFC060BXNW
- Black color \_\_\_\_\_ LUMFC060NXNW
- Bronze color \_\_\_\_\_ LUMFC060ZXNW
- Topo color \_\_\_\_\_ LUMFC060KXNW
- Grey color \_\_\_\_\_ LUMFC060SXNW
- Terracota color \_\_\_\_\_ LUMFC060TXNW
- Soft pink color \_\_\_\_\_ LUMFC060RXNW
- Soft blue color \_\_\_\_\_ LUMFC060AXNW
- Soft green color \_\_\_\_\_ LUMFC060VXNW

#### \*BASE

- Base E27 x 1 \*Supplied

## FICUS 80

DIMENSIONS CM

PACKAGING

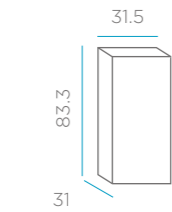
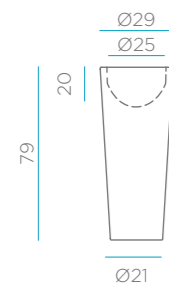

Weight: 3,85 kg  
9,5 L

Finished double wall light

Color planters/pots come in a plastic bag packaging

Options

- Smarttech (solar & rechargeable battery) \_\_\_\_\_ LUMFC080SSNW
- Outdoor cable / white light\* \_\_\_\_\_ LUMFC080OFNW
- White color \_\_\_\_\_ LUMFC080BXNW
- Black color \_\_\_\_\_ LUMFC080NXNW
- Bronze color \_\_\_\_\_ LUMFC080ZXNW
- Topo color \_\_\_\_\_ LUMFC080KXNW
- Grey color \_\_\_\_\_ LUMFC080SXNW
- Terracota color \_\_\_\_\_ LUMFC080TXNW
- Soft pink color \_\_\_\_\_ LUMFC080RXNW
- Soft blue color \_\_\_\_\_ LUMFC080AXNW
- Soft green color \_\_\_\_\_ LUMFC080VXNW

\*BASE

Base E27



x 1



\*Supplied

REFERENCES

## LIFT SUPPORT ACCESSORY

Accessory available only for Hortensia 30

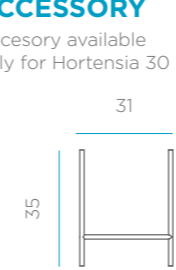

DIMENSIONS CM

PACKAGING

Options

- Support accessory 40 black color \_\_\_\_\_ JDNLIFT30041NXNW
- Support accessory 40 brass color \_\_\_\_\_ JDNLIFT30041BRNW
- Support accessory 100 black color \_\_\_\_\_ JDNLIFT30110NXNW
- Support accessory 100 brass color \_\_\_\_\_ JDNLIFT30110BRNW

## GERBERA 33

DIMENSIONS CM

PACKAGING

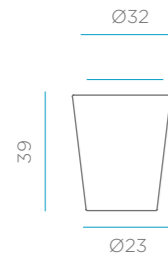

Weight: 1 kg

20L

Plastic bag

Rounded plate option

Options

- White color \_\_\_\_\_ JDNGB033BXNW
- Black color \_\_\_\_\_ JDNGB033NXNW
- Bronze color \_\_\_\_\_ JDNGB033ZXNW
- Topo color \_\_\_\_\_ JDNGB033KXNW
- Grey color \_\_\_\_\_ JDNGB033SXNW
- Terracota color \_\_\_\_\_ JDNGB033TXNW
- Soft pink color \_\_\_\_\_ JDNGB033RXNW
- Soft blue color \_\_\_\_\_ JDNGB033AXNW
- Soft green color \_\_\_\_\_ JDNGB033VXNW

REFERENCES

## GERBERA 45

DIMENSIONS CM

PACKAGING

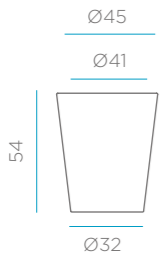

Weight: 2,2 kg

55L

Plastic bag

Rounded plate option

Options

- White color \_\_\_\_\_ JDNGB045BXNW
- Black color \_\_\_\_\_ JDNGB045NXNW
- Bronze color \_\_\_\_\_ JDNGB045ZXNW
- Topo color \_\_\_\_\_ JDNGB045KXNW
- Grey color \_\_\_\_\_ JDNGB045SXNW
- Terracota color \_\_\_\_\_ JDNGB045TXNW
- Soft pink color \_\_\_\_\_ JDNGB045RXNW
- Soft blue color \_\_\_\_\_ JDNGB045AXNW
- Soft green color \_\_\_\_\_ JDNGB045VXNW

REFERENCES

## GERBERA 50

DIMENSIONS CM

PACKAGING

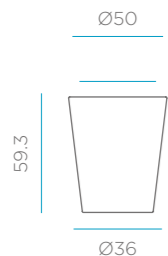

Weight: 4 kg

73L

Plastic bag

Rounded 40 plate option

Options

- White color \_\_\_\_\_ JDNGB050BXNW
- Black color \_\_\_\_\_ JDNGB050NXNW
- Bronze color \_\_\_\_\_ JDNGB050ZXNW
- Topo color \_\_\_\_\_ JDNGB050KXNW
- Grey color \_\_\_\_\_ JDNGB050SXNW

REFERENCES

## HIEDRA

DIMENSIONS CM

PACKAGING

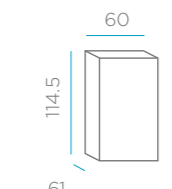
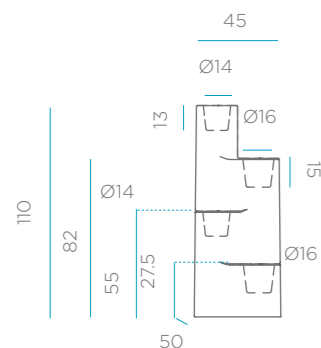

Weight: 9,9 kg

2L

3L

Finished double wall

Color finish plastic bag

Options

- Outdoor cable / white light\* \_\_\_\_\_ LUMNC050OFNW
- White color \_\_\_\_\_ JDNNC050BXNW
- Black color \_\_\_\_\_ JDNNC050NXNW
- Bronze color \_\_\_\_\_ JDNNC050ZXNW
- Topo color \_\_\_\_\_ JDNNC050KXNW
- Grey color \_\_\_\_\_ JDNNC050SXNW

\*BASE

Base E27



x 1



\*Supplied

REFERENCES

## HORTENSIA 30

DIMENSIONS CM

PACKAGING



Plastic bag  
Weight: 1 kg

18L

Support accessory

Options

- White color \_\_\_\_\_ JDNHOR030BXNW
- Black color \_\_\_\_\_ JDNHOR030NXNW
- Bronze color \_\_\_\_\_ JDNHOR030ZXNW
- Topo color \_\_\_\_\_ JDNHOR030KXNW
- Grey color \_\_\_\_\_ JDNHOR030SXNW
- Terracota color \_\_\_\_\_ JDNHOR030TXNW
- Soft pink color \_\_\_\_\_ JDNHOR030RXNW
- Soft green color \_\_\_\_\_ JDNHOR030VXNW

REFERENCES

## HORTENSIA 40

DIMENSIONS CM

PACKAGING



Plastic bag  
Weight: 2,5 kg

40L

Options

- White color \_\_\_\_\_ JDNHOR040BXNW
- Black color \_\_\_\_\_ JDNHOR040NXNW
- Bronze color \_\_\_\_\_ JDNHOR040ZXNW
- Topo color \_\_\_\_\_ JDNHOR040KXNW
- Grey color \_\_\_\_\_ JDNHOR040SXNW
- Terracota color \_\_\_\_\_ JDNHOR040TXNW
- Soft pink color \_\_\_\_\_ JDNHOR040RXNW
- Soft green color \_\_\_\_\_ JDNHOR040VXNW

REFERENCES

## HORTENSIA 50

DIMENSIONS CM

PACKAGING



Plastic bag  
Weight: 4 kg

81L

Options

- White color \_\_\_\_\_ JDNHOR050BXNW
- Black color \_\_\_\_\_ JDNHOR050NXNW
- Bronze color \_\_\_\_\_ JDNHOR050ZXNW
- Topo color \_\_\_\_\_ JDNHOR050KXNW
- Grey color \_\_\_\_\_ JDNHOR050SXNW
- Terracota color \_\_\_\_\_ JDNHOR050TXNW
- Soft pink color \_\_\_\_\_ JDNHOR050RXNW
- Soft green color \_\_\_\_\_ JDNHOR050VXNW

REFERENCES

## HORTENSIA 80

DIMENSIONS CM

PACKAGING

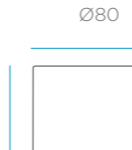

Plastic bag  
Weight: 12 kg

343L

Options

- White color \_\_\_\_\_ JDNHOR080BXNW
- Black color \_\_\_\_\_ JDNHOR080NXNW
- Bronze color \_\_\_\_\_ JDNHOR080ZXNW
- Topo color \_\_\_\_\_ JDNHOR080KXNW
- Grey color \_\_\_\_\_ JDNHOR080SXNW
- Terracota color \_\_\_\_\_ JDNHOR080TXNW
- Soft pink color \_\_\_\_\_ JDNHOR080RXNW
- Soft green color \_\_\_\_\_ JDNHOR080VXNW

REFERENCES

## JARA 100X35

DIMENSIONS CM

PACKAGING

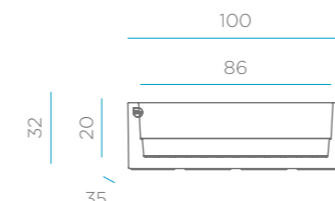

Peso: 7 kg

52L

Plastic bag

Finished double wall

Options

- White color \_\_\_\_\_ JDNJR100BXNW
- Black color \_\_\_\_\_ JDNJR100NXNW
- Bronze color \_\_\_\_\_ JDNJR100ZXNW
- Topo color \_\_\_\_\_ JDNJR100KXNW
- Grey color \_\_\_\_\_ JDNJR100SXNW
- Terracota color \_\_\_\_\_ JDNJR100TXNW

REFERENCES

**JARA 100X40** DIMENSIONS CM

**PACKAGING**

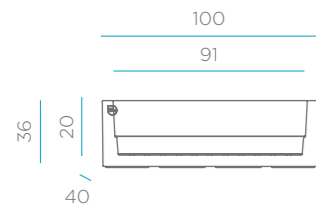

Weight: 8 kg  
6L  
Plastic bag  
Finished double wall

**Options**

- White color \_\_\_\_\_ JDNJR140BXNW ○
- Black color \_\_\_\_\_ JDNJR140NXNW ●
- Bronze color \_\_\_\_\_ JDNJR140ZXNW ●
- Topo color \_\_\_\_\_ JDNJR140KXNW ●
- Grey color \_\_\_\_\_ JDNJR140SXNW ●
- Terracota color \_\_\_\_\_ JDNJR140TXNW ●

**REFERENCES**

**JUNCO 80** DIMENSIONS CM

**PACKAGING**

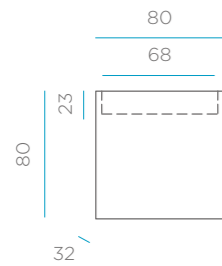

Weight: 12 kg  
39L  
Color finish plastic bag  
Finished double wall

**Options**

- Smarttech (solar & rechargeable battery) \_\_\_\_\_ LUMJN080SSNW
- Outdoor cable / white light\* \_\_\_\_\_ LUMJN080OFNW
- White color \_\_\_\_\_ JDNJN080BXNW ○
- Black color \_\_\_\_\_ JDNJN080NXNW ●
- Bronze color \_\_\_\_\_ JDNJN080ZXNW ●
- Topo color \_\_\_\_\_ JDNJN080KXNW ●
- Grey color \_\_\_\_\_ JDNJN080SXNW ●
- Terracota color \_\_\_\_\_ JDNJN080TXNW ●

**\*BASE**

Base E27 x 1 \*Supplied

**REFERENCES**

**MAGNOLIA 30** DIMENSIONS CM

**PACKAGING**



Weight: 2,10 kg  
8L / 4L  
Color finish plastic bag  
Finished double wall light

**Options**

- Smarttech (solar & rechargeable battery) \_\_\_\_\_ LUMMG030SSNW
- Outdoor cable / white light\* \_\_\_\_\_ LUMMG030OFNW
- White color \_\_\_\_\_ JDNMG030BXNW ○
- Black color \_\_\_\_\_ JDNMG030NXNW ●
- Bronze color \_\_\_\_\_ JDNMG030ZXNW ●
- Topo color \_\_\_\_\_ JDNMG030KXNW ●
- Grey color \_\_\_\_\_ JDNMG030SXNW ●
- Terracota color \_\_\_\_\_ JDNMG030TXNW ●
- Soft pink color \_\_\_\_\_ JDNMG030RXNW ●
- Soft blue color \_\_\_\_\_ JDNMG030AXNW ●
- Soft green color \_\_\_\_\_ JDNMG030VXNW ●

**\*BASE**

Base E27 x 1 \*Supplied

**REFERENCES**

**MAGNOLIA 45** DIMENSIONS CM

**PACKAGING**

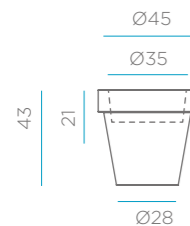

Weight: 4,8 kg  
33 L / 19L  
Color finish plastic bag  
Finished double wall light

**Options**

- Smarttech (solar & rechargeable battery) \_\_\_\_\_ LUMMG045SSNW
- Outdoor cable / white light\* \_\_\_\_\_ LUMMG045OFNW
- White color \_\_\_\_\_ JDNMG045BXNW ○
- Black color \_\_\_\_\_ JDNMG045NXNW ●
- Bronze color \_\_\_\_\_ JDNMG045ZXNW ●
- Topo color \_\_\_\_\_ JDNMG045KXNW ●
- Grey color \_\_\_\_\_ JDNMG045SXNW ●
- Terracota color \_\_\_\_\_ JDNMG045TXNW ●
- Soft pink color \_\_\_\_\_ JDNMG045RXNW ●
- Soft blue color \_\_\_\_\_ JDNMG045AXNW ●
- Soft green color \_\_\_\_\_ JDNMG045VXNW ●

**\*BASE**

Base E27 x 1 \*Supplied

**REFERENCES**

**MAGNOLIA 60** DIMENSIONS CM

**PACKAGING**

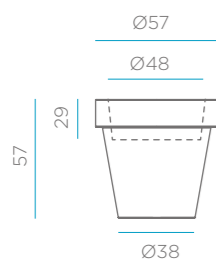

Weight: 7,9 kg  
82 L / 37 L  
Color finish plastic bag  
Finished double wall light

**Options**

- Smarttech (solar & rechargeable battery) \_\_\_\_\_ LUMMG090SSNW
- Outdoor cable / white light\* \_\_\_\_\_ LUMMG090OFNW
- White color \_\_\_\_\_ JDNMG090BXNW ○
- Black color \_\_\_\_\_ JDNMG090NXNW ●
- Bronze color \_\_\_\_\_ JDNMG090ZXNW ●
- Topo color \_\_\_\_\_ JDNMG090KXNW ●
- Grey color \_\_\_\_\_ JDNMG090SXNW ●
- Terracota color \_\_\_\_\_ JDNMG090TXNW ●

**\*BASE**

Base E27 x 1 \*Supplied

**REFERENCES**

**MAGNOLIA 90** DIMENSIONS CM

**PACKAGING**

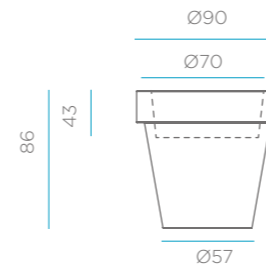

Weight: 15,86 kg  
278 L / 168 L  
Big size!  
Weight limit: 140 Kg  
Plastic bag  
Finished double wall light

**Options**

- Smarttech (solar & rechargeable battery) \_\_\_\_\_ LUMMG090SSNW
- Outdoor cable / white light\* \_\_\_\_\_ LUMMG090OFNW
- White color \_\_\_\_\_ JDNMG090BXNW ○
- Black color \_\_\_\_\_ JDNMG090NXNW ●
- Bronze color \_\_\_\_\_ JDNMG090ZXNW ●
- Topo color \_\_\_\_\_ JDNMG090KXNW ●
- Grey color \_\_\_\_\_ JDNMG090SXNW ●
- Terracota color \_\_\_\_\_ JDNMG090TXNW ●

**\*BASE**

Base E27 x 1 \*Supplied

**REFERENCES**

**MAGNOLIA 130** DIMENSIONS CM

**PACKAGING**

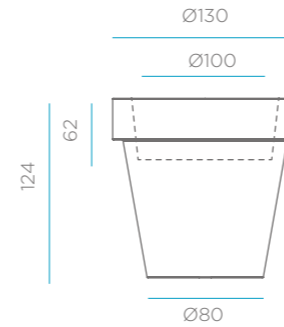

Weight: 61,42 kg  
831 L / 535 L  
Big Size!  
Weight limit: 300 Kg  
Plastic bag  
Finished double wall light

**Options**

- Smarttech (solar & rechargeable battery) \_\_\_\_\_ LUMMG130SSNW
- Outdoor cable / white light\* \_\_\_\_\_ LUMMG130OFNW
- White color \_\_\_\_\_ JDNMG130BXNW ○
- Black color \_\_\_\_\_ JDNMG130NXNW ●
- Bronze color \_\_\_\_\_ JDNMG130ZXNW ●
- Topo color \_\_\_\_\_ JDNMG130KXNW ●
- Grey color \_\_\_\_\_ JDNMG130SXNW ●
- Terracota color \_\_\_\_\_ JDNMG130TXNW ●

**\*BASE**

Base E27 x 1 \*Supplied

**REFERENCES**

**MELISA 30** DIMENSIONS CM

**PACKAGING**

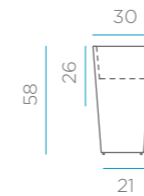

Weight: 4,62 kg  
11 L / 7 L  
Color finish plastic bag  
Finished double wall light

**Options**

- Smarttech (solar & rechargeable battery) \_\_\_\_\_ LUMML030SSNW
- Outdoor cable / white light\* \_\_\_\_\_ LUMML030OFNW
- White color \_\_\_\_\_ JDNML030BXNW ○
- Black color \_\_\_\_\_ JDNML030NXNW ●
- Bronze color \_\_\_\_\_ JDNML030ZXNW ●
- Topo color \_\_\_\_\_ JDNML030KXNW ●
- Grey color \_\_\_\_\_ JDNML030SXNW ●
- Terracota color \_\_\_\_\_ JDNML030TXNW ●

**\*BASE**

Base E27 x 1 \*Supplied

**REFERENCES**

**MELISA 40** DIMENSIONS CM

**PACKAGING**

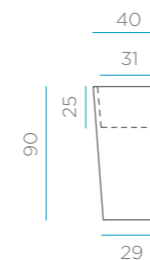

Weight: 7,8 kg  
12L  
Color finish plastic bag  
Finished double wall light

**Options**

- Smarttech (solar & rechargeable battery) \_\_\_\_\_ LUMML040SSNW
- Outdoor cable / white light\* \_\_\_\_\_ LUMML040OFNW
- White color \_\_\_\_\_ JDNML040BXNW ○
- Black color \_\_\_\_\_ JDNML040NXNW ●
- Bronze color \_\_\_\_\_ JDNML040ZXNW ●
- Topo color \_\_\_\_\_ JDNML040KXNW ●
- Grey color \_\_\_\_\_ JDNML040SXNW ●
- Terracota color \_\_\_\_\_ JDNML040TXNW ●

**\*BASE**

Base E27 x 1 \*Supplied

**REFERENCES**

**MELISA 50** DIMENSIONS CM

**PACKAGING**

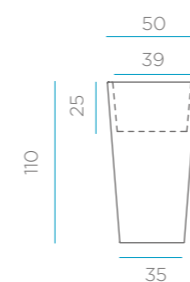

Weight: 11,86 kg  
14L  
Squared plate 40 option  
Color finish plastic bag  
Finished double wall light

**Options**

- Smarttech (solar & rechargeable battery) \_\_\_\_\_ LUMML050SSNW
- Outdoor cable / white light\* \_\_\_\_\_ LUMML050OFNW
- White color \_\_\_\_\_ JDNML050BXNW ○
- Black color \_\_\_\_\_ JDNML050NXNW ●
- Bronze color \_\_\_\_\_ JDNML050ZXNW ●
- Topo color \_\_\_\_\_ JDNML050KXNW ●
- Grey color \_\_\_\_\_ JDNML050SXNW ●
- Terracota color \_\_\_\_\_ JDNML050TXNW ●

**\*BASE**

Base E27 x 1 \*Supplied

**REFERENCES**

**NARCISO 35** DIMENSIONS CM PACKAGING REFERENCES

Weight: 2 kg  
17L

Plastic bag  
Squared plate 40 option

**Options**

White color	_____	JDNNC035BXNW	○
Black color	_____	JDNNC035NXNW	●
Bronze color	_____	JDNNC035ZXNW	●
Topo color	_____	JDNNC035KXNW	●
Grey color	_____	JDNNC035SXNW	●
Terracota color	_____	JDNNC035TXNW	●
Soft pink color	_____	JDNNC035RXNW	●
Soft blue color	_____	JDNNC035AXNW	●
Soft green color	_____	JDNNC035VXNW	●

**NARCISO 40** DIMENSIONS CM PACKAGING REFERENCES

Weight: 4,13 kg  
28L / 9L

Color finish plastic bag  
Finished double wall light

**Options**

Smarttech (solar & rechargeable battery)	_____	LUMNC040SSNW	🌞🔋
Outdoor cable / white light*	_____	LUMNC040OFNW	🔌💡
White color	_____	JDNNC040BXNW	○
Black color	_____	JDNNC040NXNW	●
Bronze color	_____	JDNNC040ZXNW	●
Topo color	_____	JDNNC040KXNW	●
Grey color	_____	JDNNC040SXNW	●
Terracota color	_____	JDNNC040TXNW	●
Soft pink color	_____	JDNNC040RXNW	●
Soft blue color	_____	JDNNC040AXNW	●
Soft green color	_____	JDNNC040VXNW	●

**\*BASE**

Base E27 x 1 \*Supplied

**NARCISO 50** DIMENSIONS CM PACKAGING REFERENCES

Weight: 7,92 kg  
54 L / 19L

Squared plate 50 option  
Color finish plastic bag  
Finished double wall light

**Options**

Smarttech (solar & rechargeable battery)	_____	LUMNC050SSNW	🌞🔋
Outdoor cable / white light*	_____	LUMNC050OFNW	🔌💡
White color	_____	JDNNC050BXNW	○
Black color	_____	JDNNC050NXNW	●
Bronze color	_____	JDNNC050ZXNW	●
Topo color	_____	JDNNC050KXNW	●
Grey color	_____	JDNNC050SXNW	●
Terracota color	_____	JDNNC050TXNW	●

**\*BASE**

Base E27 x 1 \*Supplied

**NARCISO 60** DIMENSIONS CM PACKAGING REFERENCES

Weight: 7 kg  
85L

Plastic bag

**Options**

White color	_____	JDNNC060BXNW	○
Black color	_____	JDNNC060NXNW	●
Bronze color	_____	JDNNC060ZXNW	●
Topo color	_____	JDNNC060KXNW	●
Grey color	_____	JDNNC060SXNW	●
Terracota color	_____	JDNNC060TXNW	●

**PALMA 70** DIMENSIONS CM PACKAGING REFERENCES

Weight: 5,35 kg  
9 L

Color finish plastic bag  
Finished double wall

**Options**

Smarttech (solar & rechargeable battery)	_____	LUMPM070SSNW	🌞🔋
Outdoor cable / white light*	_____	LUMPM070OFNW	🔌💡
White color	_____	JDNPM070BXNW	○
Black color	_____	JDNPM070NXNW	●
Bronze color	_____	JDNPM070ZXNW	●
Topo color	_____	JDNPM070KXNW	●
Terracota color	_____	JDNPM070TXNW	●

**\*BASE**

Base E27 x 1 \*Supplied

**PALMERA** DIMENSIONS CM PACKAGING REFERENCES

Weight: 10,71 kg  
23L

Color finish plastic bag  
Finished double wall

**Options**

Smarttech (solar & rechargeable battery)	_____	LUMPA080SSNW	🌞🔋
Outdoor cable / white light*	_____	LUMPA080OFNW	🔌💡
White color	_____	JDNPA080BXNW	○
Black color	_____	JDNPA080NXNW	●
Bronze color	_____	JDNPA080ZXNW	●
Topo color	_____	JDNPA080KXNW	●
Grey color	_____	JDNPA080SXNW	●

**\*BASE**

Base E27 x 1 \*Supplied

**VIOLETA 30** DIMENSIONS CM PACKAGING REFERENCES

Weight: 1 kg  
13L

Plastic bag

**Options**

White color	_____	JDNVL030BXNW	○
Black color	_____	JDNVL030NXNW	●
Bronze color	_____	JDNVL030ZXNW	●
Topo color	_____	JDNVL030KXNW	●
Grey color	_____	JDNVL030SXNW	●
Terracota color	_____	JDNVL030TXNW	●
Soft pink color	_____	JDNVL030RXNW	●
Soft blue color	_____	JDNVL030AXNW	●
Soft green color	_____	JDNVL030VXNW	●

**VIOLETA 40** DIMENSIONS CM PACKAGING REFERENCES

Weight: 3,81 kg  
31L / 15L

Color finish plastic bag  
Finished double wall light

**Options**

Smarttech (solar & rechargeable battery)	_____	LUMVL040SSNW	🌞🔋
Outdoor cable / white light*	_____	LUMVL040OFNW	🔌💡
White color	_____	JDNVL040BXNW	○
Black color	_____	JDNVL040NXNW	●
Bronze color	_____	JDNVL040ZXNW	●
Topo color	_____	JDNVL040KXNW	●
Grey color	_____	JDNVL040SXNW	●
Soft pink color	_____	JDNVL040RXNW	●
Soft blue color	_____	JDNVL040AXNW	●
Soft green color	_____	JDNVL040VXNW	●

**\*BASE**

Base E27 x 1 \*Supplied

**VIOLETA 55** DIMENSIONS CM PACKAGING REFERENCES

Weight: 6,93 kg  
68L / 35L

Color finish plastic bag  
Finished double wall light  
Rounded plate option

**Options**

Smarttech (solar & rechargeable battery)	_____	LUMVL055SSNW	🌞🔋
Outdoor cable / white light*	_____	LUMVL055OFNW	🔌💡
White color	_____	JDNVL055BXNW	○
Black color	_____	JDNVL055NXNW	●
Bronze color	_____	JDNVL055ZXNW	●
Topo color	_____	JDNVL055KXNW	●
Grey color	_____	JDNVL055SXNW	●
Terracota color	_____	JDNVL055TXNW	●

**\*BASE**

Base E27 x 1 \*Supplied

## 8- PLACE A BULB / TUBE

PLACE A BULB  
lamp holder E27

All our products include a base screwed cap to change a bulb.

\* Check product model



Some Newgarden products use lamp holders G13 (led tube)



## 9- BAR FIXATION KIT

Combine two articles: Ibiza/Sicilia/Creta bar.

Place the fixation plate to the desired length and mark the drilling holes ends.

Screw fixation plate.

Attach the plastic applique with screws included.

x2  \*Fixation kit not included with the product  
x4 

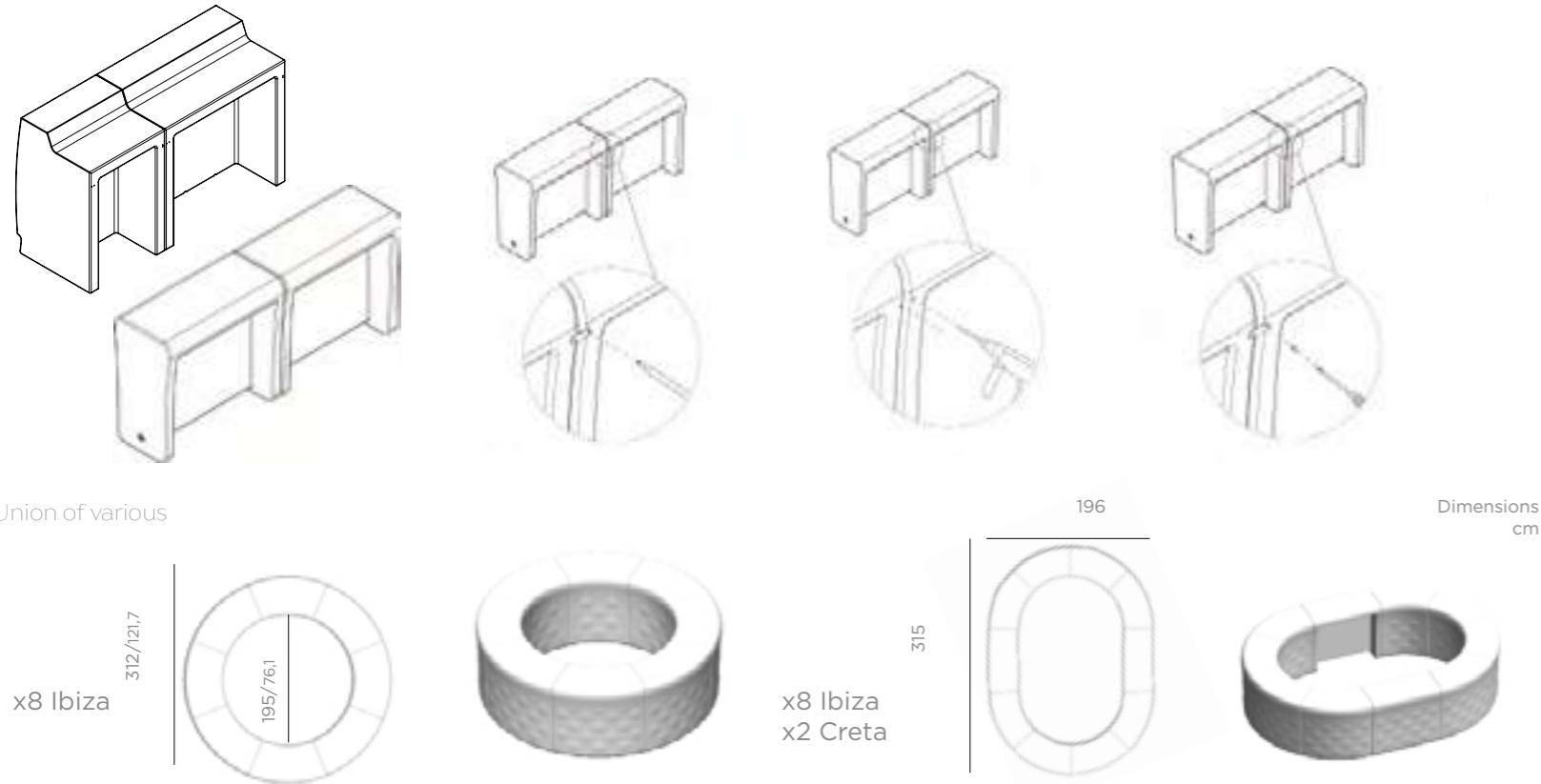



Attachment bar fixation kit includes:

- Screws
- Plastic applique

## 10- FIXATION RECOMMENDATIONS

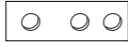
If you want to fix Newgarden products to the floor:

x4  Supplied  
x8 

Place the product upright.

Drill base product.

Screw the plate on the base.

Attach the plate to the floor.

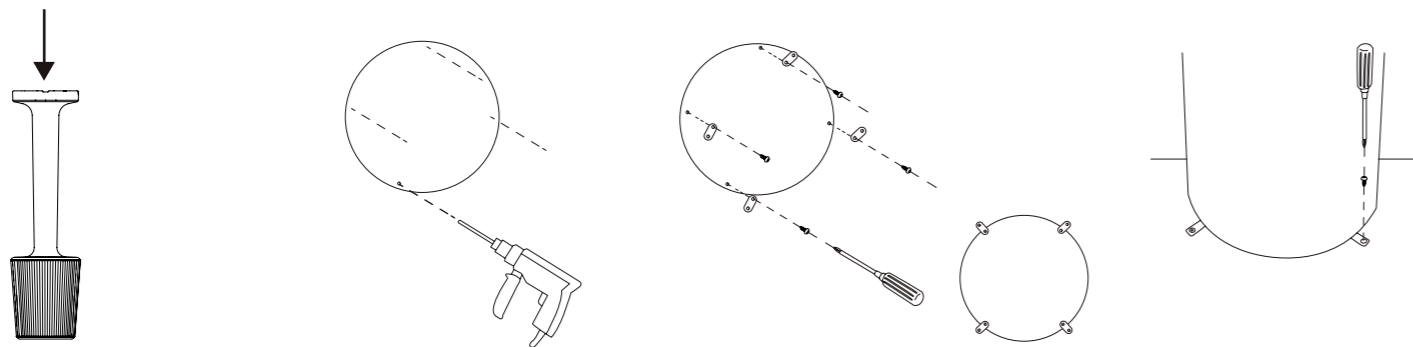

## 11- PLANTING SYSTEM

There are three different types of planting system in pots.

- A. No water reservoir
- B. Water reservoir
- C. Light planters plantation

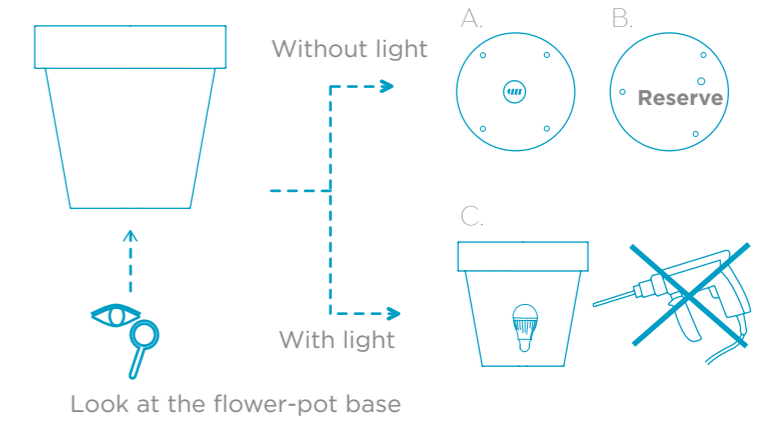

### A. No water reservoir planting // B. Water reservoir planting

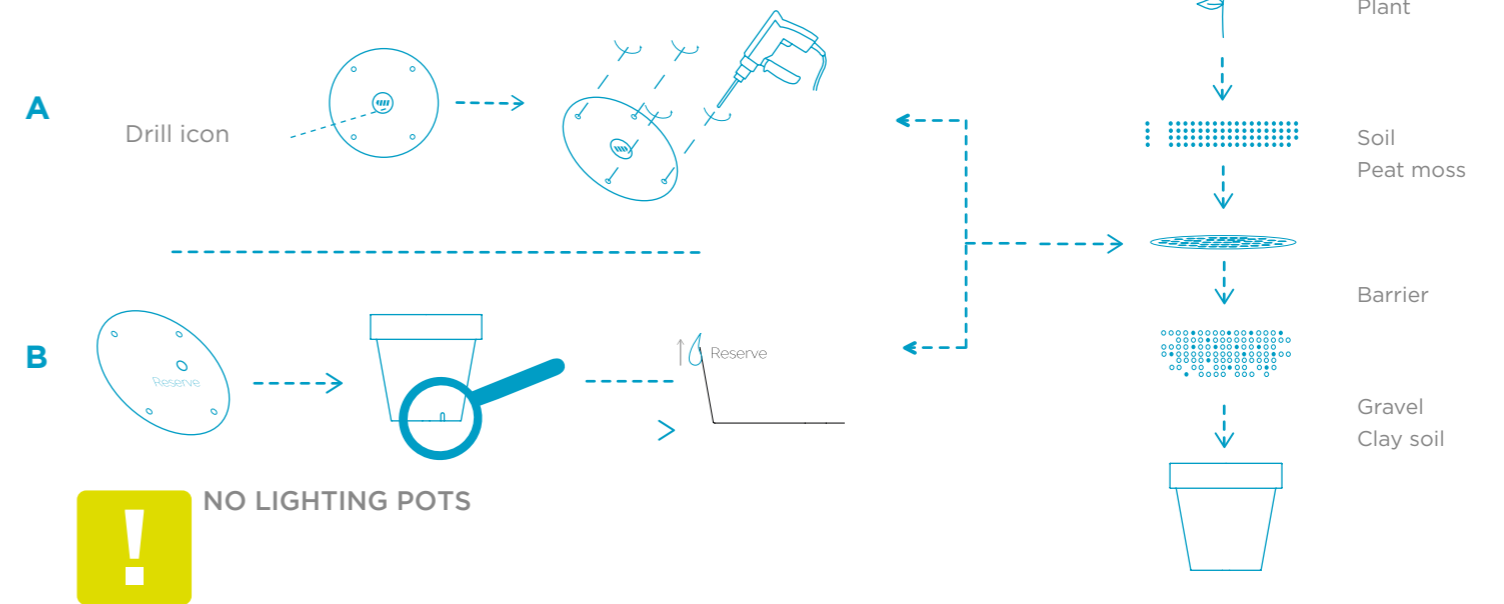

### C. Lighting pots planting

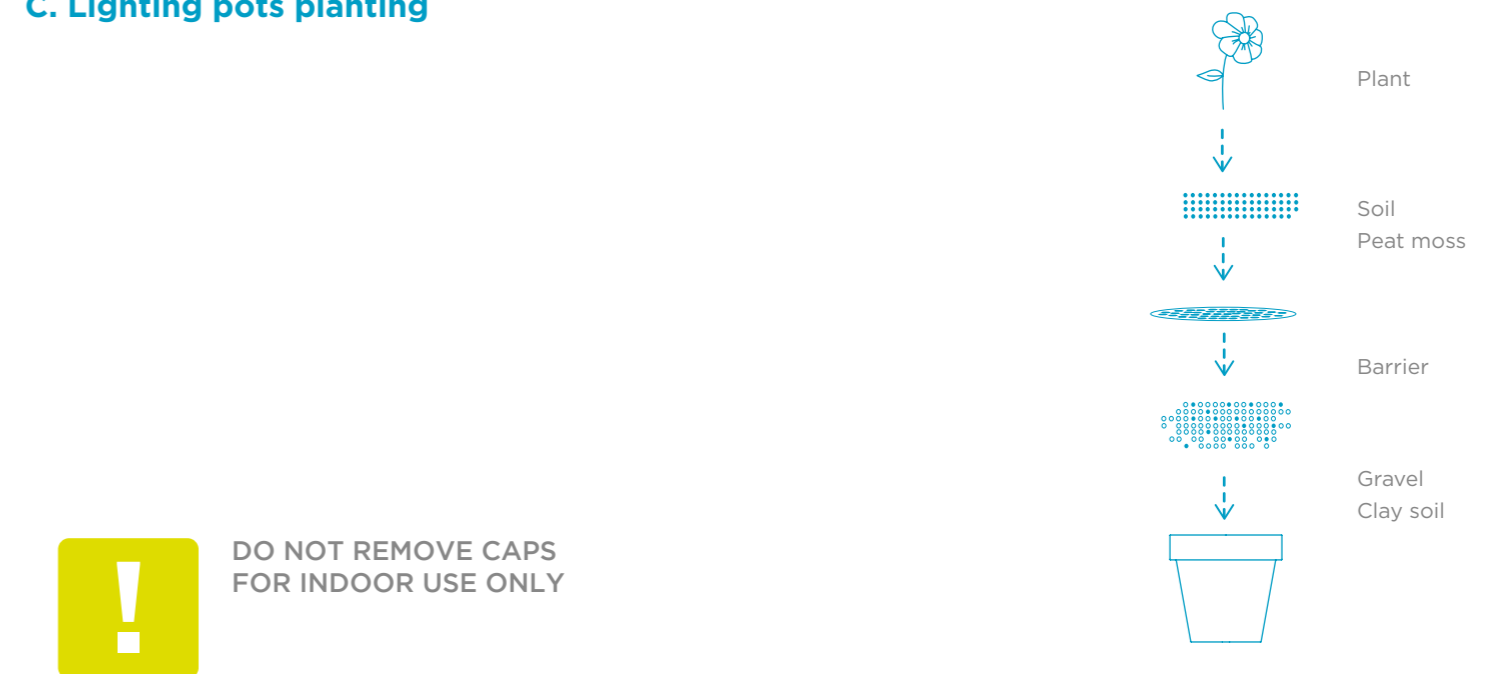

\*Our planting instructions have been designed to respect product's capacity and security measures. Any planting system that does not comply with usage guidelines may affect the product status and no claims will be accepted



The possible differences between the original color, illumination and color captured are due to the printing technique.

NEWGARDEN reserves the right over photographs and designs made, so it is forbidden the manufacture, distribution and / or marketing of the products shown on any medium or support.

NEWGARDEN reserves the right to modify, in whole or in part, without prior notice, any information or technical specification of this publication.

All the information that appears in this catalog in terms of dimensions and capacity are approximate and are susceptible to variations due to improvements in the production process.

#BeHappy

@ Copyright. 2019. Newgarden Spain.  
Todos los derechos reservados

**Avenida de Francia, 5-15 30840  
Alhama de Murcia. Murcia (Spain)**

**info@newgarden.es  
T. +34 968978806**

