

Geometry

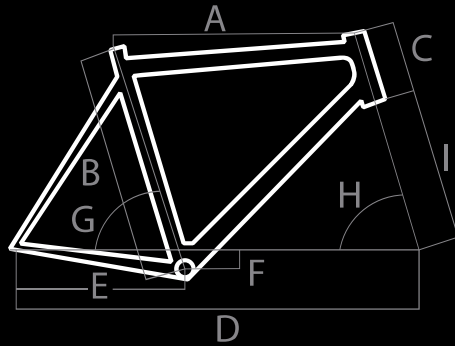

Ridott 26"

Size			
A	Top tube (horizontal)	533	mm
B	Seat tube	360	mm
C	Head tube length	100	mm
D	Well base	1010	mm
E	Chain stays	423	mm
F	Bottom bracketed drop	35	mm
G	Seat tube angle	73,5	°
H	Head tube angle	71	°
I	Fork lenght	460	mm

Ridott 24"

Size			
A	Top tube (horizontal)	534	mm
B	Seat tube	340	mm
C	Head tube length	110	mm
D	Well base	1000	mm
E	Chain stays	410	mm
F	Bottom bracketed drop	30	mm
G	Seat tube angle	73	°
H	Head tube angle	71	°
I	Fork lenght	410	mm

Lauren 24"

Size			
A	Top tube (horizontal)	490	mm
B	Seat tube	340	mm
C	Head tube length	110	mm
D	Well base	960	mm
E	Chain stays	410	mm
F	Bottom bracketed drop	26	mm
G	Seat tube angle	73	°
H	Head tube angle	70	°
I	Fork lenght	418	mm

Marion 24"

Size			
A	Top tube (horizontal)	525	mm
B	Seat tube	340	mm
C	Head tube length	110	mm
D	Well base	985	mm
E	Chain stays	405	mm
F	Bottom bracketed drop	25	mm
G	Seat tube angle	73	°
H	Head tube angle	71	°
I	Fork lenght	380	mm

Ridott 20"

Size			
A	Top tube (horizontal)	455	mm
B	Seat tube	290	mm
C	Head tube length	110	mm
D	Well base	865	mm
E	Chain stays	360	mm
F	Bottom bracketed drop	15	mm
G	Seat tube angle	73	°
H	Head tube angle	71	°
I	Fork lenght	360	mm

Lauren 20"

Size			
A	Top tube (horizontal)	455	mm
B	Seat tube	290	mm
C	Head tube length	110	mm
D	Well base	831	mm
E	Chain stays	365	mm
F	Bottom bracketed drop	16	mm
G	Seat tube angle	68	°
H	Head tube angle	70,5	°
I	Fork lenght	363	mm

Marion 20"

Size			
A	Top tube (horizontal)	440	mm
B	Seat tube	290	mm
C	Head tube length	110	mm
D	Well base	861	mm
E	Chain stays	360	mm
F	Bottom bracketed drop	15	mm
G	Seat tube angle	73	°
H	Head tube angle	71	°
I	Fork lenght	328	mm

Junior 16"

Size			
A	Top tube (horizontal)	365	mm
B	Seat tube	235	mm
C	Head tube length	100	mm
D	Well base	670	mm
E	Chain stays	270	mm
F	Bottom bracketed drop	10	mm
G	Seat tube angle	75,4	°
H	Head tube angle	71	°
I	Fork lenght	235	mm

Faro 12"

Size			
A	Top tube (horizontal)	300	mm
B	Seat tube	130	mm
C	Head tube length	70	mm
D	Well base	558	mm
E	Chain stays	243	mm
F	Bottom bracketed drop	/	mm
G	Seat tube angle	69,6	°
H	Head tube angle	70	°
I	Fork lenght	219,1	mm

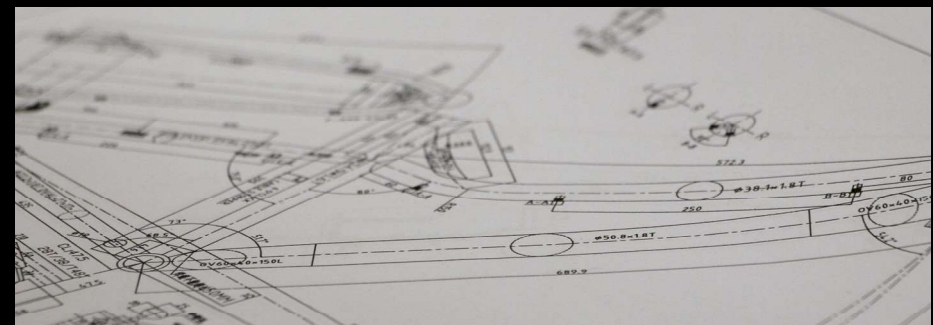



Audrey Merle

Audrey Merle, born 1995 in Clermont-Ferrand, is a French triathlete. She is riding a custom made HEAD Bicycle.

Audrey is 2015 Triathlon World Champion U23 and she is participating at the Olympic Games in Rio de Janeiro (Brazil) in 2016.





Techno Team Marseille HEAD

We bet on the youth, that's the reason why we are supporting Techno Team Marseille HEAD, with our Trenton models.

These racers from France are between 16 to 17 years old, they are participating in French Cup cross-country and French championships.



KS Luboń Skomielna Biala

This is our polish racing team. It's already the 2nd season, when this team is racing on HEAD Bikes. Results are going up very fast.

Here are some of them:

Maciek Biedronczyk:

2nd place in the Polish Cup – Skolmielna Biala

3rd place in the Polish Cup – Tuchów

3rd place in the Polish Cup – Bialystok

Jaroslaw Zur:

1st place in the Polish Cup - Tuchów

1st place in the Polish Cup – Skolmielna Biala

1st place in the Polish Cup – Boguszów Gorce



HEAD Bike Team Opava

This is our hometown racing team. We are not focused on professional racers, we are focused on hobby bikers, who enjoy bicycling. Our team already counts more than 80 members and it's growing every year.

It's not always just about racing, but bicycling is also about fun!!



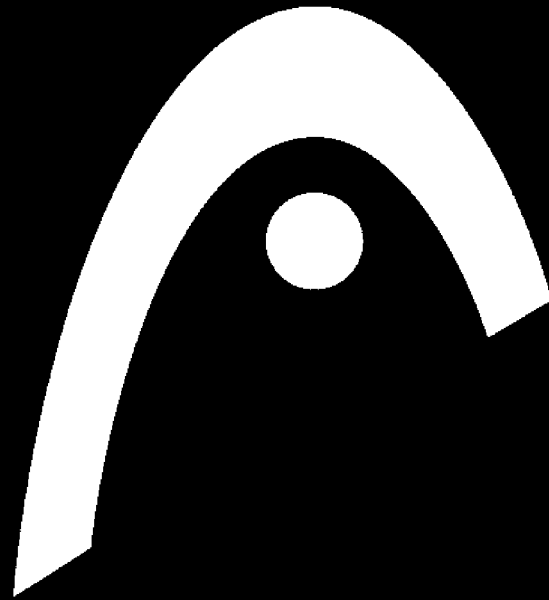













THE POWER OF YOU



Dictionary/ Lexikon/ Slovník

	>>	Front fork	Gabel	Vidlice		>>	Brakes	Bremsen	Brzdy		>>	Rims	Felgen	Ráfky
	>>	Rear shock	Dämpfer	Zadní tlumič		>>	Front hub	Nabe vorne	Přední náboj		>>	Saddle	Sattel	Sedlo
	>>	Head set	Steuersatz	Hlavové složení		>>	Rear hub	Nabe hinten	Zadní náboj		>>	Pedals	Pedale	Pedály
	>>	Shift levers	Schalthebel	Řazení		>>	Frame	Rahmen	Rám		>>	Headlight	Scheinwerfer	Přední světlo
	>>	Rear derailleur	Schaltwerk	Přehazovačka		>>	Frame height	Rahmenhöhe	Výška rámu		>>	Rearlight	Rücklicht	Zadní světlo
	>>	Front derailleur	Umwerfer	Přesmyk		>>	Frame colour	Rahmenfarbe	Barva rámu		>>	Motor	Motor	Motor
	>>	Crank set	Kurbel	Převodník		>>	Weight	Gewicht	Váha		>>	Stem	Vorbau	Představec
	>>	Cassette	Kassette	Kazeta		>>	Tires	Reifen	Pláště		>>	Handlebar	Lenker	Řídítka
											>>	Seatpost	Sattelstütze	Sedlovka

**PRODUCER AND MAIN DISTRIBUTOR
FOR GERMANY, AUSTRIA,
CZECH REPUBLIC AND SLOVAKIA**

Novus Bike s.r.o.

Vančurova 2985/20
746 01 Opava
www.head-bike.com
info@head-bike.com
<https://facebook.com/headbicycles>

BULGARIA

VELOZONA

Burgas
Tel. No.: +0359 887 800 104
www.velozona-bg.com
velozona@mail.bg
velozona@abv.bg

FINLAND

PowerFactory

Kaskimäenkatu 7, 33900 Tampere
Tel. No: +358-20-122 2555
asiakaspalvelu@uimonen.fi
www.powerfactory.fi
<https://www.facebook.com/powerfactoryfinland>

FRANCE

Goes Europe - Headcycles
105 Bd de Chanzy
93 100 Montreuil
France
Tel. No.: +33 1 41 58 62 65
welcome@headcycles.com
www.headcycles.com
<https://www.facebook.com/headcycles>
<https://twitter.com/@headcycles>

GREECE

ACTION-BIKES

48 Pentelis Avenue
15234 Halandri -Athens
Tel. No.: 2106846632 - 2106894471
www.action-bikes.gr
www.headbikes.gr
info@action-bikes.gr
<https://www.facebook.com/actionbikesgreece>

HUNGARY, ROMANIA

WINTERSPORT Co. Ltd.

Csillaghegyi Street 36
1037 Budapest
Tel. No.: +36 70 376 0640 or +36 30 9481404
www.head-bike.hu
wintersport@wintersport.hu



LITHUANIA, LATVIA, ESTONIA

Dvirtex

Raudondvario 99, Kaunas
Tel. No.: 8-650-38888
www.dvirtex.lt
info@dvirtex.lt
<https://www.facebook.com/Dvirtex.lt>

POLAND

Pro Sport

Kwiatowa 40
45-569 Opole
Tel. No.: +48 (0) 77 453 7008
GSM: +48 (0) 508239109
www.head-bikes.pl
info@head-bikes.pl
<https://www.facebook.com/HeadBikespl>

RUSSIA

Torro

Volgogradky prospekt, 45, office 248
Moscow 109316
Tel. No.: +7 499 653 8183
info@torrocompany.ru

SLOVENIA, CROATIA

INTERSPORT ISI d.o.o.

Cesta na Okroglo 3
4202 Naklo
Slovenija
Tel. No.: 04/ 256-84-29 or 04/ 256-84-83
informacije@intersport.si
<https://www.facebook.com/IntersportSlovenija>
https://www.youtube.com/channel/UCf9y3Icfy-QQuPP_j7K0ZO3g

SPAIN, PORTUGAL, ANDORRA

Jets Marivent

CERRO DE LA BUTRERA 3
28223, POZUELO DE ALARCON, MADRID, ESPAÑA
www.jetsmarivent.com
Tel. No.: +34 91 357 92 92
info@jetsmarivent.com
<https://www.facebook.com/JETS.MARIVENT>
<https://www.facebook.com/HEADbicyclespain>
<https://twitter.com/%21/jetsmarivent>



HEAD®

Barevné odchylky a technické změny vyhrazeny.
Neonové barvy mohou v průběhu času změnit svůj odstín. Neručíme za tiskové chyby.
Farbabweichungen und Technische Änderungen vorbehalten.
Neonfarben können im Laufe der Zeit ihre Tönung ändern. Keine Gewähr für Druckfehler.
Color deviations and technical changes reserved.
Neon colors may change shade during time. No guarantee for printing errors.