

COMPATIBILITY OF CONNECTORS

	CTM	CLMH	CSM	CIM	CPM	CRM	CGM
CTF	•						
CKF	•						
CHF		•					
CSF			•				
CIF				•	•	•	•
CVF				•	•	•	•
CCF				•	•	•	•
CGF				•	•	•	•

CTF + CTM

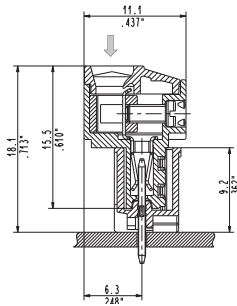

CTF + CTM_0

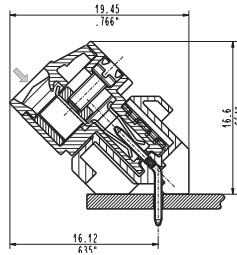

CTF + CTM_4

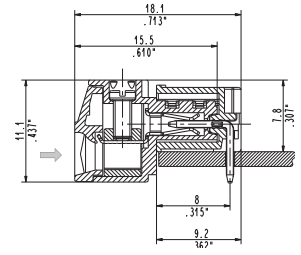

CTF + CTM_9



CKF + CTM

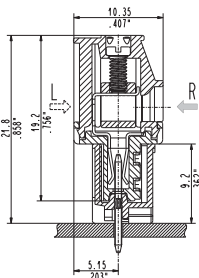

CKF + CTM_0

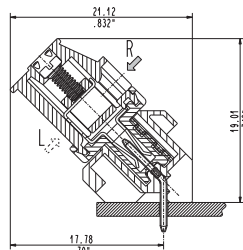

CKF + CTM_4

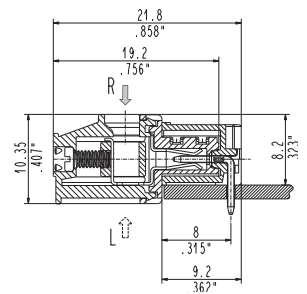

CKF + CTM_9



CSF + CSM

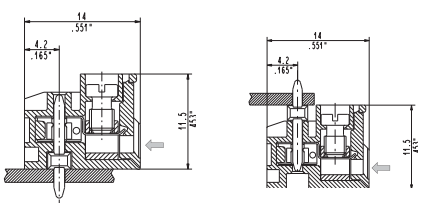

Industrial Use
Specific for the 90° and 270° Insertion

CSF_09 + CSM

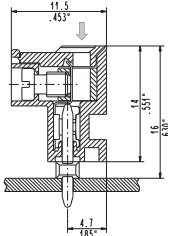

Industrial Use
Specific for the Straight Insertion

CSF_01 + CSM

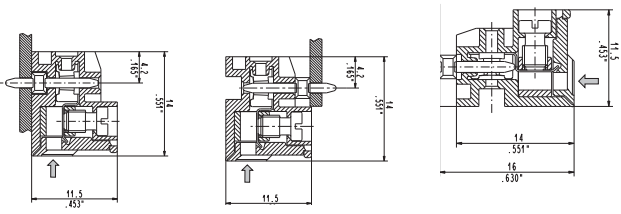

Versatile Use
For Prototypes and stock products

CSF_00 + CSM



CSF_0J + CSM CSF_0F + CSM

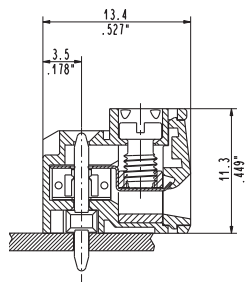

CSF_0J + CSM

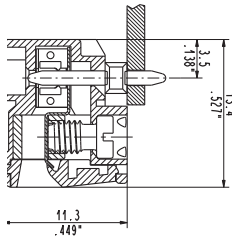

CSF_0F + CSM

CSF_0S + CSM

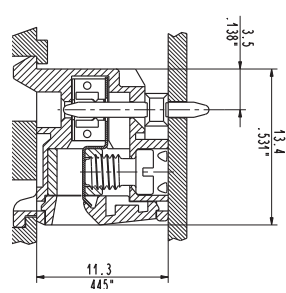

CSF_0S + CSM

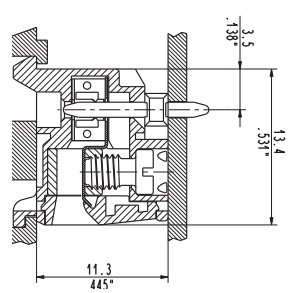

CSF_0G + CSM

CIF + CIM

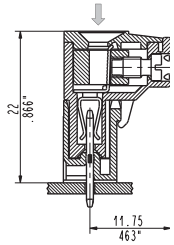

CIF + CIM 0

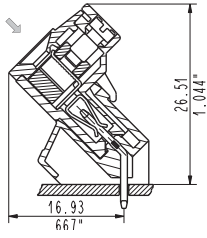

CIF + CIM 4

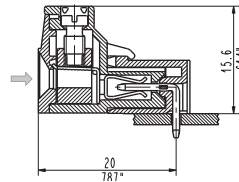

CIF + CIM 9



CIF + CPM

Metric Pitches

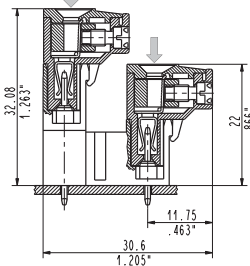

Imperial Pitches

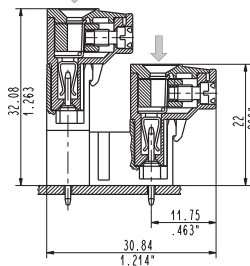

CIF + CPM 0

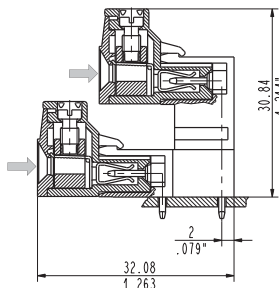
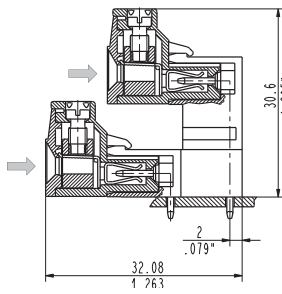

CIF + CPM 9



CIF + CRM

Metric Pitches

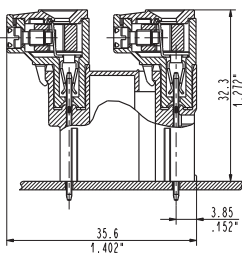

Imperial Pitches

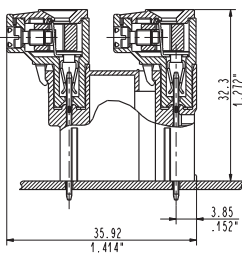

CIF + CRM 0



Metric Pitches

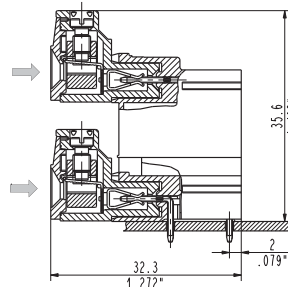

Imperial Pitches

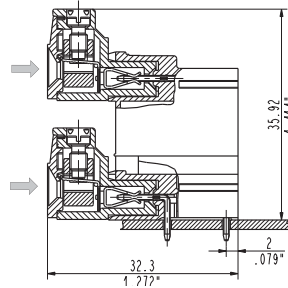

CIF + CRM 9

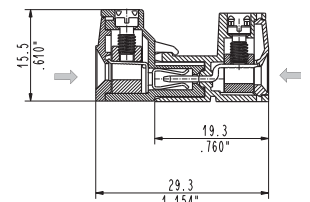

CIF + CGM

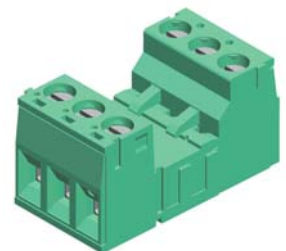

CVF + CIM

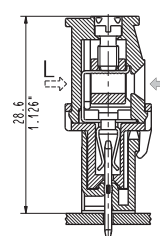

CVF + CIM_0

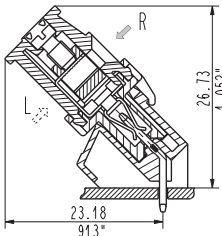

CVF + CIM_4

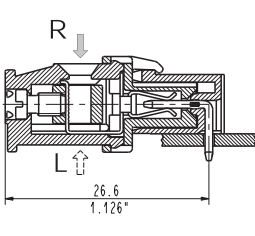

CVF + CIM_9

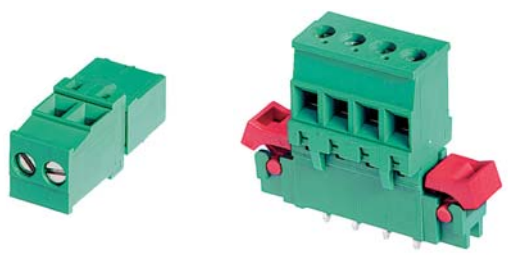

CVF + CPM

Metric Pitches

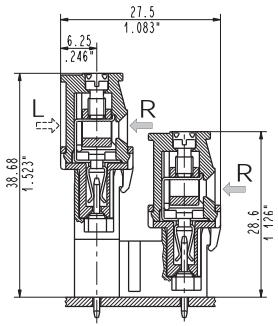

Imperial Pitches

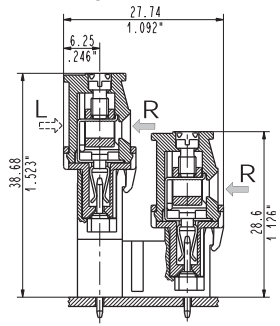

CVF + CPM_0

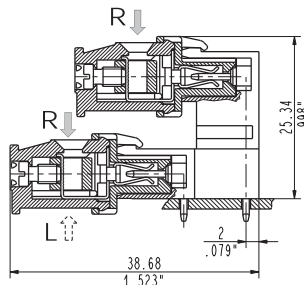
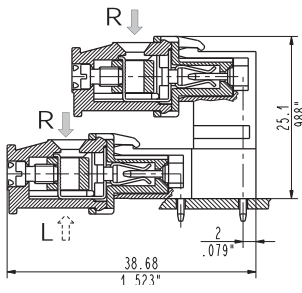

CVF + CPM_9



CVF + CRM

Metric Pitches

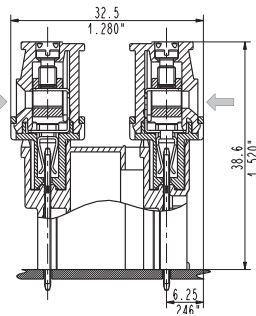

CVF + CRM_0

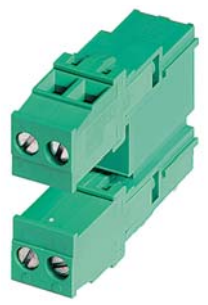

Metric Pitches

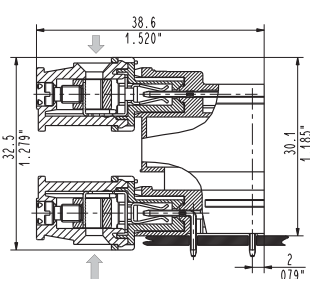

CVF + CRM_9

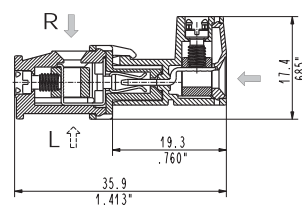

CVF + CGM



Imperial Pitches

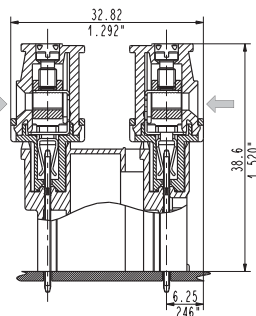

Imperial Pitches

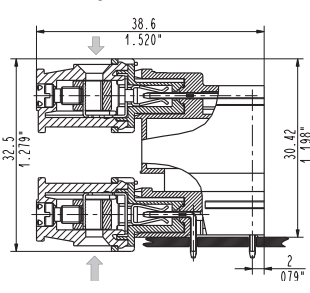

CCF + CIM

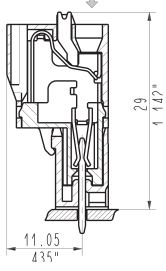

CCF + CIM_0

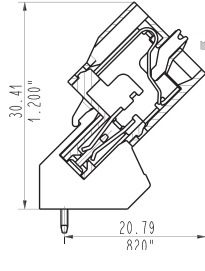

CCF + CIM_4

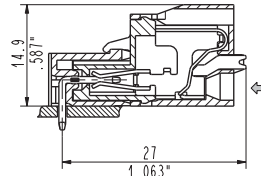

CCF + CIM_9



CCF + CPM

Metric Pitches

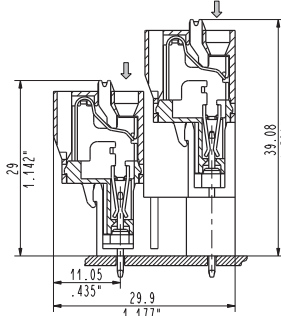

Imperial Pitches

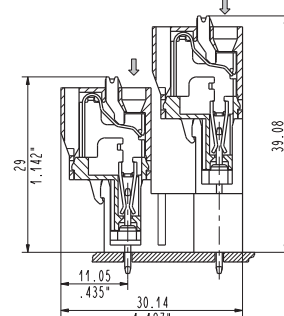

CCF + CPM_0



Metric Pitches

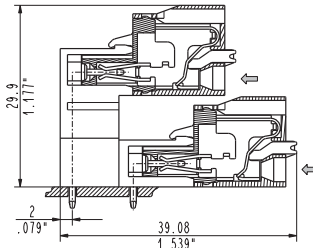

Imperial Pitches

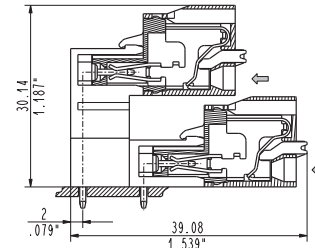

CCF + CPM_9



CCF + CRM

Metric Pitches

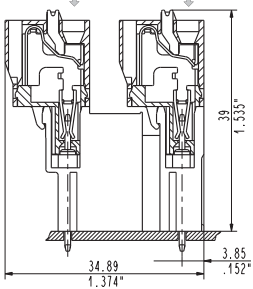

Metric Pitches

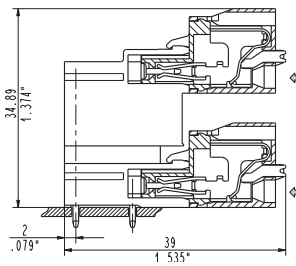

Imperial Pitches

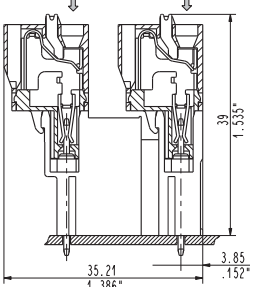

Imperial Pitches

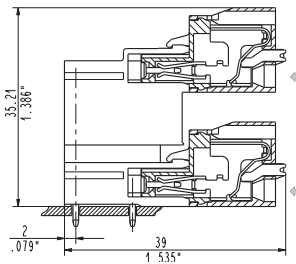

CCF + CRM_0

CCF + CRM_9

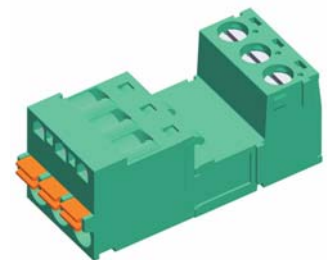
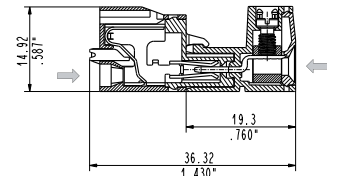

CCF + CGM

CGF + CGM

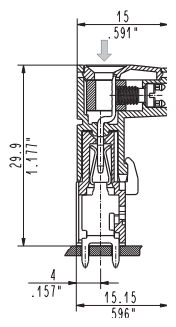

CGF_0 + CGM

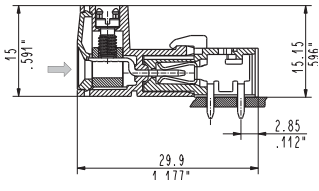

CGF_9 + CGM



CGF + CIM

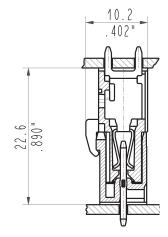

CGF_0 + CIM_0

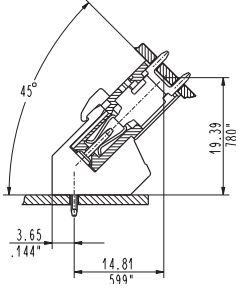

CGF_0 + CIM_4

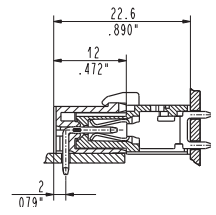

CGF_0 + CIM_9

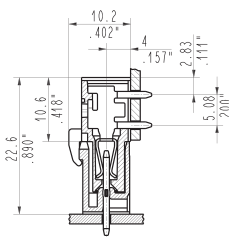

CGF_9 + CIM_0

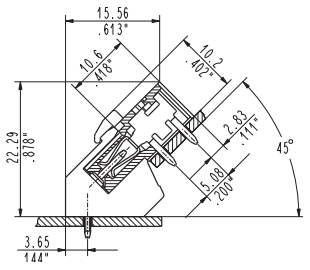

CGF_9 + CIM_4

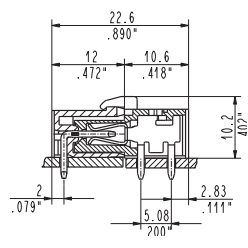

CGF_9 + CIM_9



CGF + CPM

Metric Pitches

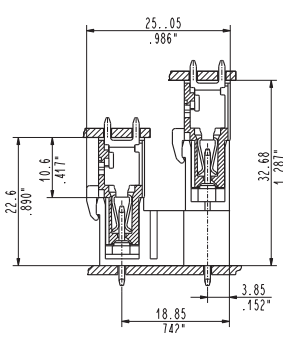

Imperial Pitches

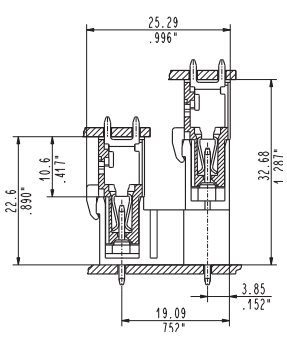

CGF_0 + CPM_0



Metric Pitches

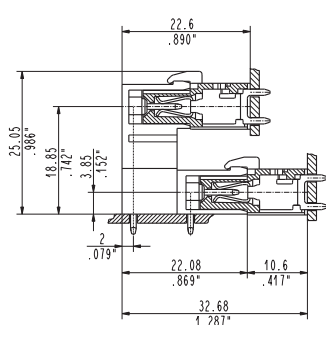

Imperial Pitches

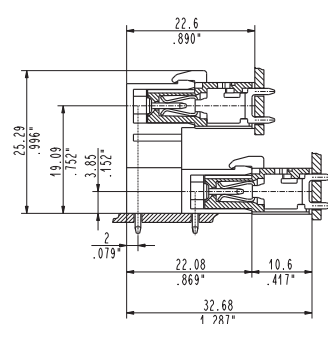

CGF_0 + CPM_9



CGF + CPM

Metric Pitches

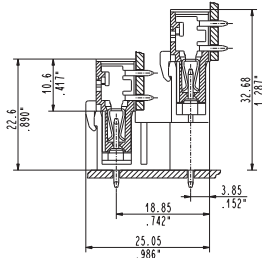

Imperial Pitches

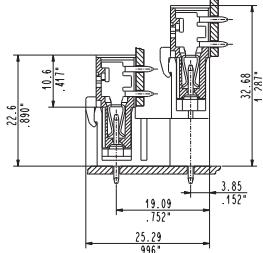

CGF 9 + CPM 0

Metric Pitches

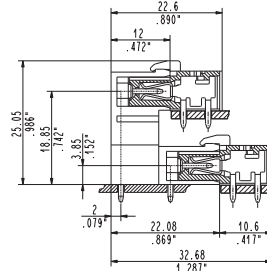

Imperial Pitches

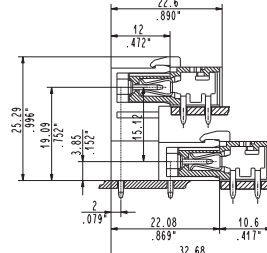

CGF 9 + CPM 9

CGF + CRM

Metric Pitches

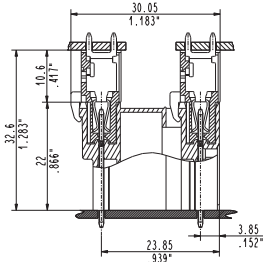

Imperial Pitches

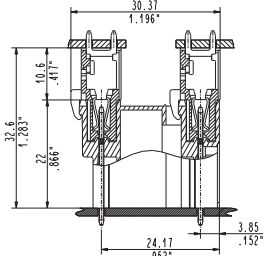

CGF 0 + CRM 0

Metric Pitches

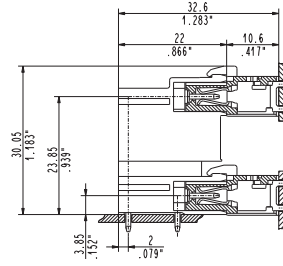

Imperial Pitches

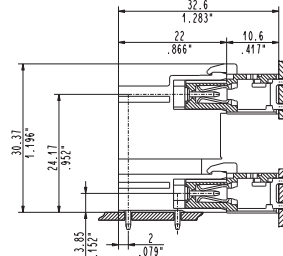

CGF 0 + CRM 9

Metric Pitches

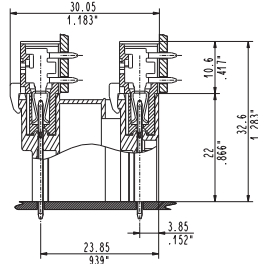

Imperial Pitches

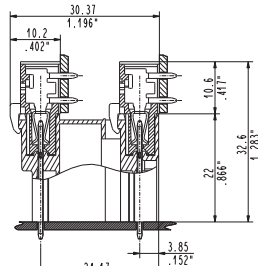

CGF 9 + CRM 0

Metric Pitches

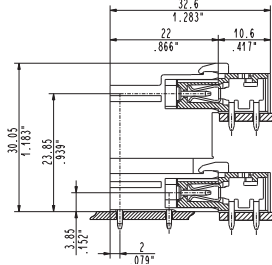

Imperial Pitches

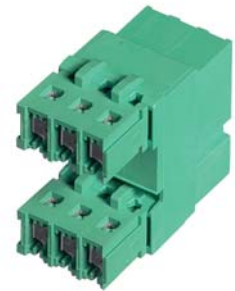
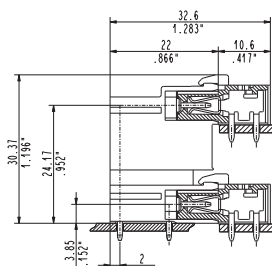

CGF 9 + CRM 9

▶ Round Angle

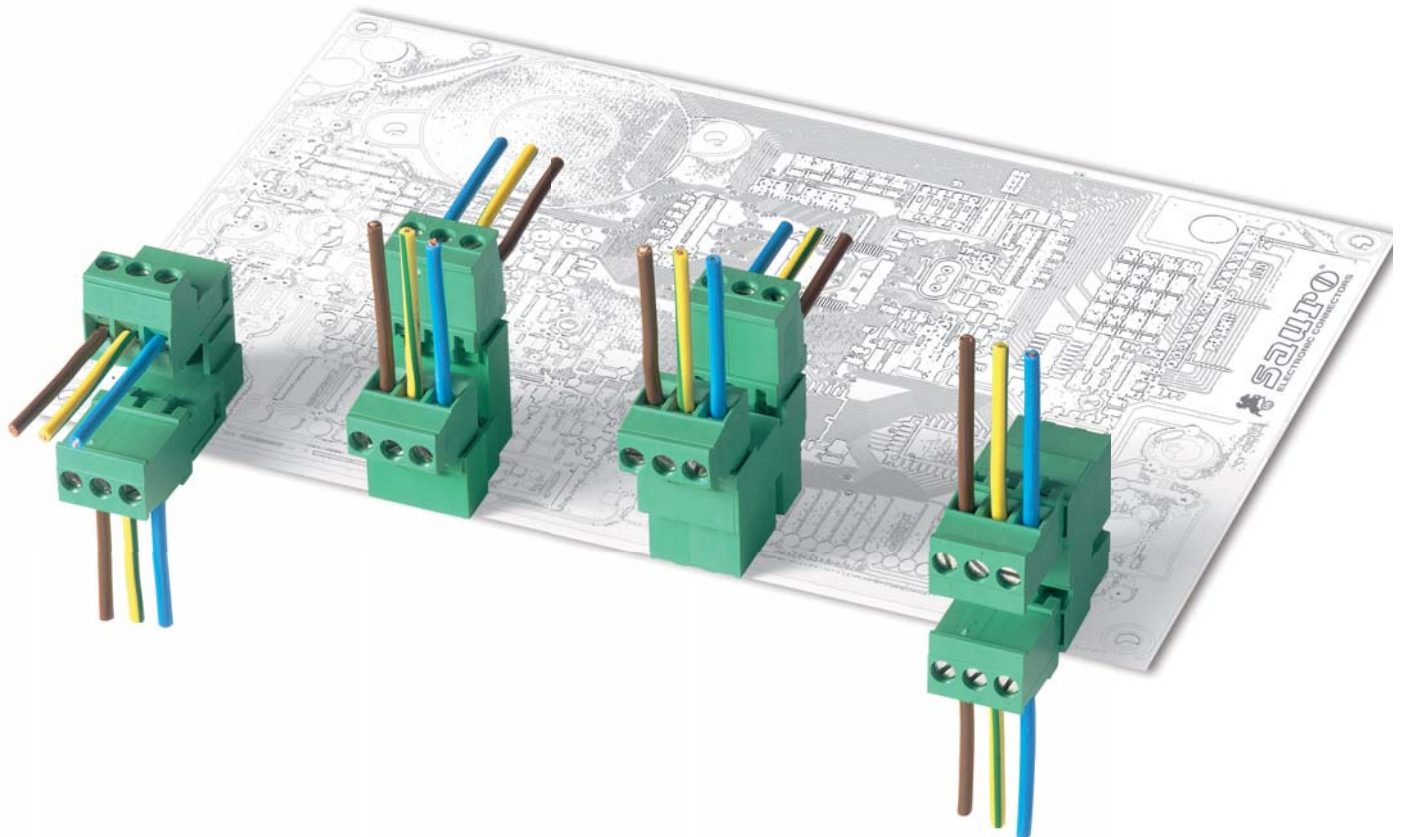
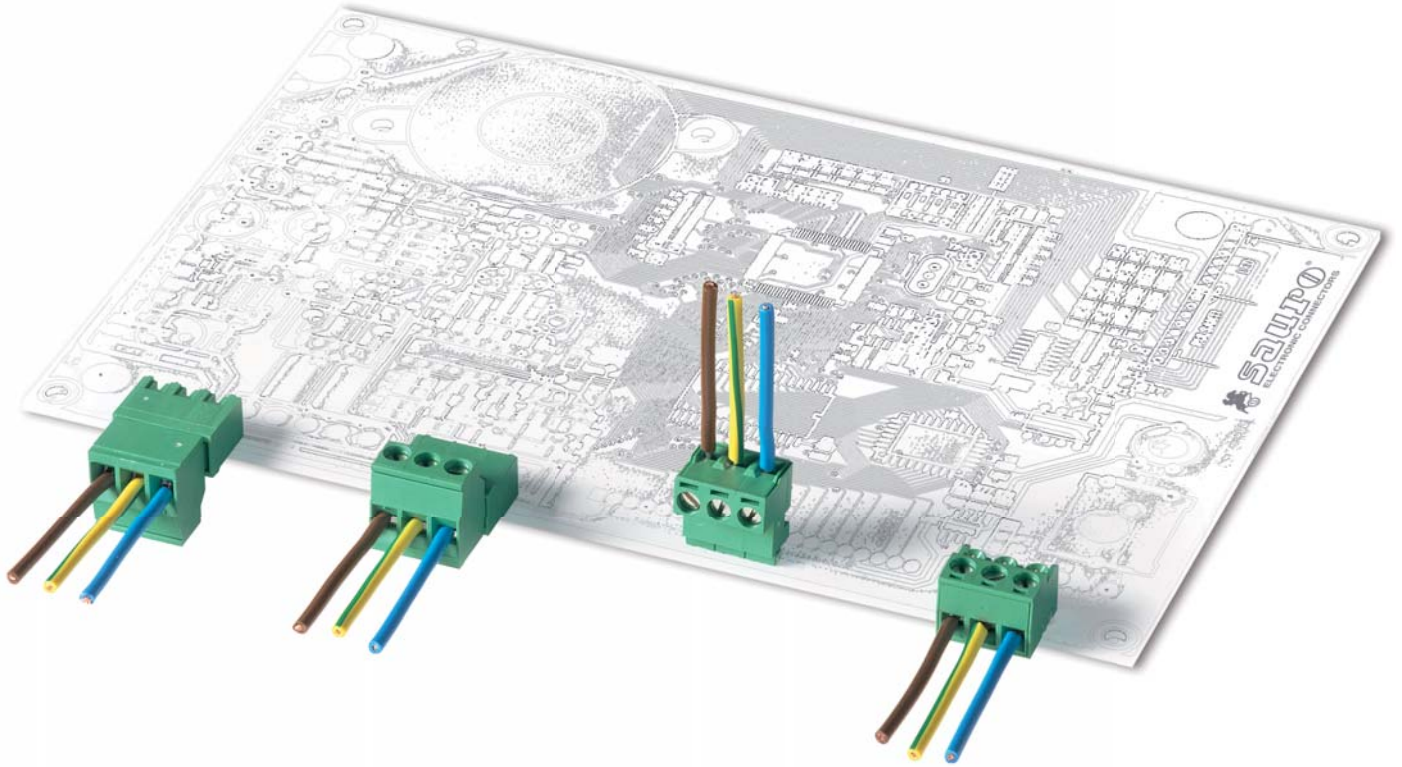
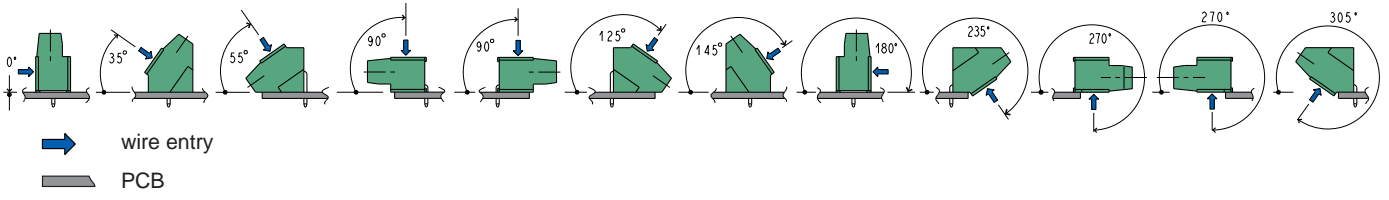

Round Angle

