

CABINAS
VESTUARIO

TOILET
CUBICLE

CABINES
COLLECTIVES

Tiberfusta

LIBERFUSTA fabrica una amplia gama de cabinas sanitarias diseñadas a medida para permitir una instalación sencilla y adaptable a cualquier espacio. Su sistema de modulación facilita un mayor aprovechamiento del habitáculo para todos los entornos incluyendo industrial, educativa, ocio, etc.

Cabinas Sanitarias perfil superior de Aluminio

Descripción:

Altura total de las cabinas de 2050mm., incluidos pies y barras.
 Tablero compacto espesor 13 mm, altura para frentes 184,5cm, altura puertas y divisorias 176,5

Herraje para puertas abatibles:

Soporte Pie Regulable en Acero Inox AISI 316
 Pernio Plano 75x80 Inox AISI 304
 Condena Inox
 Juego Doble Pomo Ø 25 mm.
 Perfil en U 1830 de Aluminio
 Perfil en U 1735 de Aluminio
 Perfil superior Aluminio

Herraje para puertas correderas:

Soporte Pie Regulable en Acero Inox AISI 316
 Guía superior puerta corredera Koblenz 500/10 anonizada
 Juego ruedas puerta corredera ref. 1050 1
 Asa diametro 19 con roseta
 Condena Inox especiales pico
 Perfil en U 1830 de Aluminio
 Perfil en U 1735 de Aluminio
 Perfil superior Aluminio

LIBERFUSTA makes a wide range of toilet cubicles designed and manufactured to measure for easy installation and a perfect fit into any space. A modular system makes it easy to get the most out of the space in all types of setting, including industrial, educational, leisure and other environments.

Toilet cubicles with aluminium top profile

Description:

Overall cubicle height 2050mm, including legs and bars.
 13mm thick compact board, fronts 184.5cm high, doors and partitions 176.5cm.

Hardware for hinged doors:

AISI 316 stainless steel adjustable leg bracket
 75x80 AISI 304 stainless steel flat hinge
 Stainless steel lock
 Pair of Ø 25mm handles
 1830 aluminium U-shaped profile
 1735 aluminium U-shaped profile
 Aluminium top profile

Hardware for sliding doors:

AISI 316 stainless steel adjustable leg bracket
 Koblenz 500/10 anodised sliding door top rail
 Ref. 1050 1 sliding door wheel set
 Ø 19 handle with rosette
 Special stainless steel lock with catch
 1830 aluminium U-shaped profile
 1735 aluminium U-shaped profile
 Aluminium top profile

LIBERFUSTA fabrique une large gamme de cabinas sanitaires sur mesure faciles : installer et adaptables à n'importe quel espace. Leur système modulaire permet une meilleure utilisation l'habitable dans tous les environnements : industriel, scolaire, loisirs, etc.

Cabinas Sanitarias perfil superior en Aluminium

Description :

Hauteur totale des cabinas : 2050 mm, y compris les pieds et les barres.
 Panneau en Compact de 13 mm d'épaisseur, 184,5 cm de hauteur pour les parois latérales, 176,5 mm de hauteur pour les portes et les cloisons.

Quincaillerie des portes rabattables :

Support de pied réglable en acier inoxydable AISI 316
 Pommelles plates 75x80 acier inoxydable AISI 304
 Verrou acier inoxydable
 Jeu double bouton Ø 25 mm.
 Profilé en U-1830 en aluminium
 Profilé en U- 1735 en aluminium
 Profilé supérieur en aluminium

Quincaillerie des portes coulissantes :

Support de pied réglable en acier inoxydable AISI 316
 Guide supérieur porte coulissante Koblenz 500/10 anodisé
 Jeu de roues porte coulissante réf. 1050 1
 Poignée diamètre 19 avec rosette
 Verrou acier inoxydable spécial en bec
 Profilé en U-1830 en aluminium
 Profilé en U-1735 en aluminium
 Profilé supérieur en aluminium

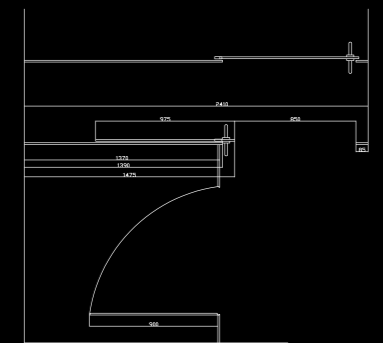
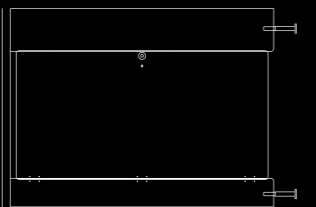
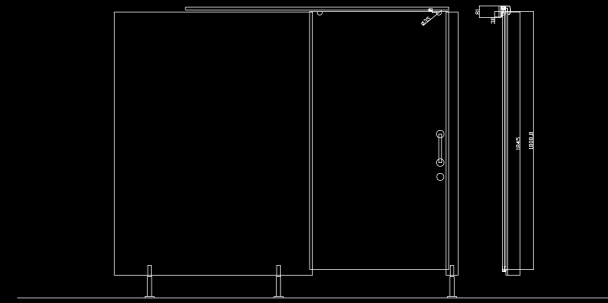
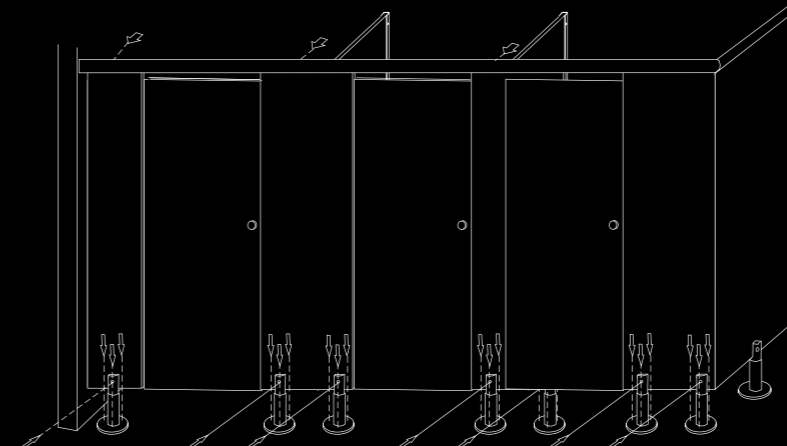

LIBERFUSTA fabrica una amplia gama de cabinas sanitarias diseñadas a medida para permitir una instalación sencilla y adaptable a cualquier espacio. Su sistema de modulación facilita un mayor aprovechamiento del habitáculo para todos los entornos incluyendo industrial, educativa, ocio, etc.

Cabinas con perfil superior de Inox.

Descripción:

Altura total de las cabinas de 2050mm., incluidos pies y barras.
Tablero compacto espesor 13 mm, altura 180 cm.

Herraje para puertas abatibles:

Soporte Pie Regulable en Acero Inox AISI 316
Pernio Plano 75x80 Inox AISI 304
Condensa Inox
Juego Doble Pomo Ø 25 mm.
Nudo Esquina Ø 45 x 45 para Tubo Ø 25 Inox Aisi 304.
Pinza Tubo Plana Inox 304
Soporte para Tubo
Perfil Angulo 30x30 mm en Aluminio
Perfil Angulo 20x20 mm en Aluminio
Perfil en U 1800 de Aluminio.
Tubo Ø 25

Herraje para puertas correderas:

Soporte Pie Regulable en Acero Inox AISI 316
Kit especial para puerta corredera.
Condensa Inox especiales pico
Juego de ruedas
Guía inferior
Tope
Asa diametro 19 con roseta
Nudo Esquina Ø 45 x 45 para Tubo Ø 25 Inox Aisi 304.
Pinza Tubo Plana Inox 304
Soporte para Tubo
Perfil Angulo 30x30 mm en Aluminio
Perfil Angulo 20x20 mm en Aluminio
Perfil en U 1800 de Aluminio.
Tubo Ø 25

LIBERFUSTA makes a wide range of toilet cubicles designed and manufactured to measure for easy installation and a perfect fit into any space. A modular system makes it easy to get the most out of the space in all types of setting, including industrial, educational, leisure and other environments.

Toilet cubicles with stainless steel top profile

Description:

Overall cubicle height 2050mm, including legs and bars.
13mm thick compact board, 180cm high.

Hardware for hinged doors:

AISI 316 stainless steel adjustable leg bracket
75x80 AISI 304 stainless steel flat hinge
Stainless steel lock
Pair of Ø 25mm handles
Ø 45 x 45 corner fitting for AISI 304 stainless steel Ø 25 tube
AISI 304 stainless steel flat tube clamp
Bracket for tube
Aluminium 30 x 30mm angle profile
Aluminium 20 x 20mm angle profile
1800 aluminium U-shaped profile
Ø 25 tube

Hardware for sliding doors:

AISI 316 stainless steel adjustable leg bracket
Special kit for sliding door
Special stainless steel lock with catch
Set of wheels
Bottom guide rail
End stop
Ø 19 handle with rosette
Ø 45 x 45 corner fitting for AISI 304 stainless steel Ø 25 tube
AISI 304 stainless steel flat tube clamp
Bracket for tube
Aluminium 30 x 30mm angle profile
Aluminium 20 x 20mm angle profile
1800 aluminium U-shaped profile
Ø 25 tube

LIBERFUSTA fabrique une large gamme de cabinas sanitaires sur mesure faciles à installer et adaptables à n'importe quel espace. Leur système modulaire permet une meilleure utilisation l'habitable dans tous les environnements : industriel, scolaire, loisirs, etc.

Cabinas à profilé supérieur en acier inoxydable.

Description :

Hauteur totale des cabinas : 2050 mm, y compris les pieds et les barres.
Panneau en Compact de 13 mm d'épaisseur, 180 cm de hauteur.

Quincaillerie des portes rabattables :

Support de pied réglable en acier inoxydable AISI 316
Pommelles plates 75x80 acier inoxydable AISI 304
Verrou acier inoxydable
Jeu double bouton Ø 25 mm.
Coin angle Ø 45 x 45 pour tube de Ø 25 acier inoxydable Aisi 304.
Pince-tube plat acier inoxydable 304
Support pour tube
Profilé angle 30x30 mm en aluminium
Profilé angle 20x20 mm en aluminium
Profilé en U 1800 en aluminium.
Tubo Ø 25

Quincaillerie des portes coulissantes :

Support de pied réglable en acier inoxydable AISI 316
Kit spécial portes coulissantes.
Verrou acier inoxydable spécial en bec
Jeu de roues
Guide inférieur
Butée

Poignée diamètre 19 avec rosette
Coin angle Ø 45 x 45 pour tube de Ø 25 Acier inoxydable Aisi 304.
Pince-tube plat acier inoxydable 304
Support pour tube
Profilé angle 30x30 mm en aluminium
Profilé angle 20x20 mm en aluminium
Profilé en U 1800 en aluminium.
Tubo Ø 25

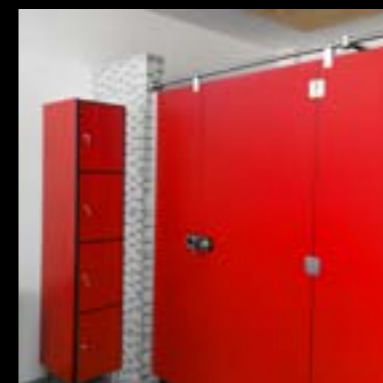
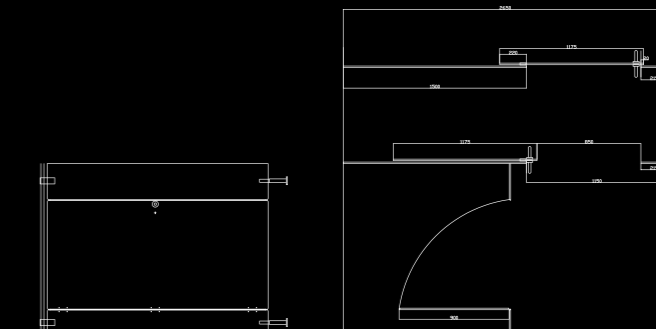
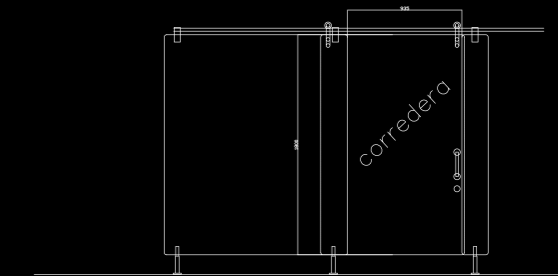
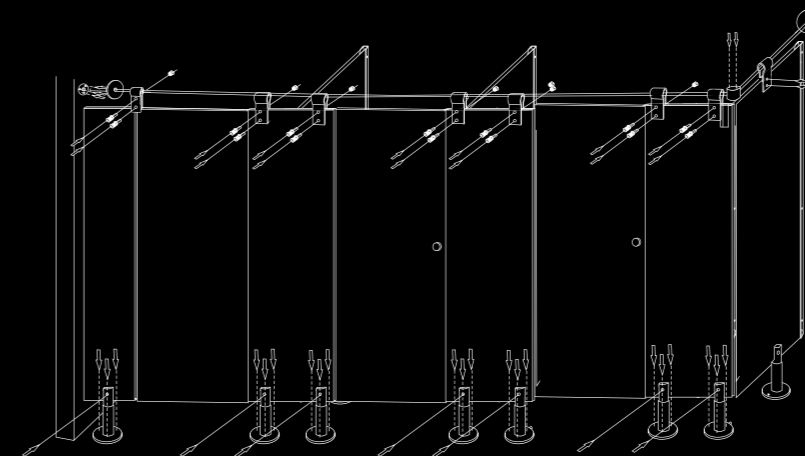

LIBERFUSTA makes a wide range of toilet cubicles designed and manufactured to measure for easy installation and a perfect fit into any space. A modular system makes it easy to get the most out of the space in all types of setting, including industrial, educational, leisure and other environments.

Sandwich panel cubicles

Cubicles in an innovative design to give a special touch to any changing room.

Description:

The front panels, doors and partitions are made using a sandwich-type construction made up of a high-density expanded polystyrene core, a compact board structure surfaced with 2.5mm thick high-pressure laminate in colours in the CUBLIC series (in stock), or in sheet aluminium or stainless steel.

Doors can be fitted with handles.

The front panels have polyamide levellers to compensate for unevenness in the floor, as they reach up to the ceiling.

Fully damp-proof benches, useful for swimming pools, spa centres and resorts, and also for changing rooms.

Wall-mounted benches, benches with shoe rack, hangers for clothes and bags, single and double units.

Benches in standard sizes and with the option of manufacturing in any size on request by the customer.

Description:
Changing room benches made with 13mm thick phenolic stratified resin board.

30 x 30mm AISI 304 stainless steel tubular structure, finished off with black feet and legs which are adjustable in height.

Compact board and aluminium hangers.

LIBERFUSTA fabrique une large gamme de cabines sanitaires sur mesure faciles à installer et adaptables à n'importe quel espace. Leur système modulaire permet une meilleure utilisation l'habitacle dans tous les environnements : industriel, scolaire, loisirs, etc.

Cabines à panneau sandwich.

Des cabines à la conception novatrice qui donnent une touche particulière au vestiaire.

Description :

Les panneaux latéraux, les panneaux des portes et des cloisons sont réalisés selon le procédé sandwich composé d'une âme de polystyrène expansé haute densité, d'un châssis de panneau en Compact, recouvert des deux côtés de stratifié haute pression de 2,5 mm d'épaisseur, coloris série CUBLIC EN STOCK, ou d'une feuille d'aluminium ou d'acier inoxydable.

Les portes peuvent être équipées de poignées.

Le bas des panneaux latéraux est équipé de régulateurs de niveau en polyamide qui permettent de compenser les imperfections du sol, étant donné qu'ils vont jusqu'au toit.

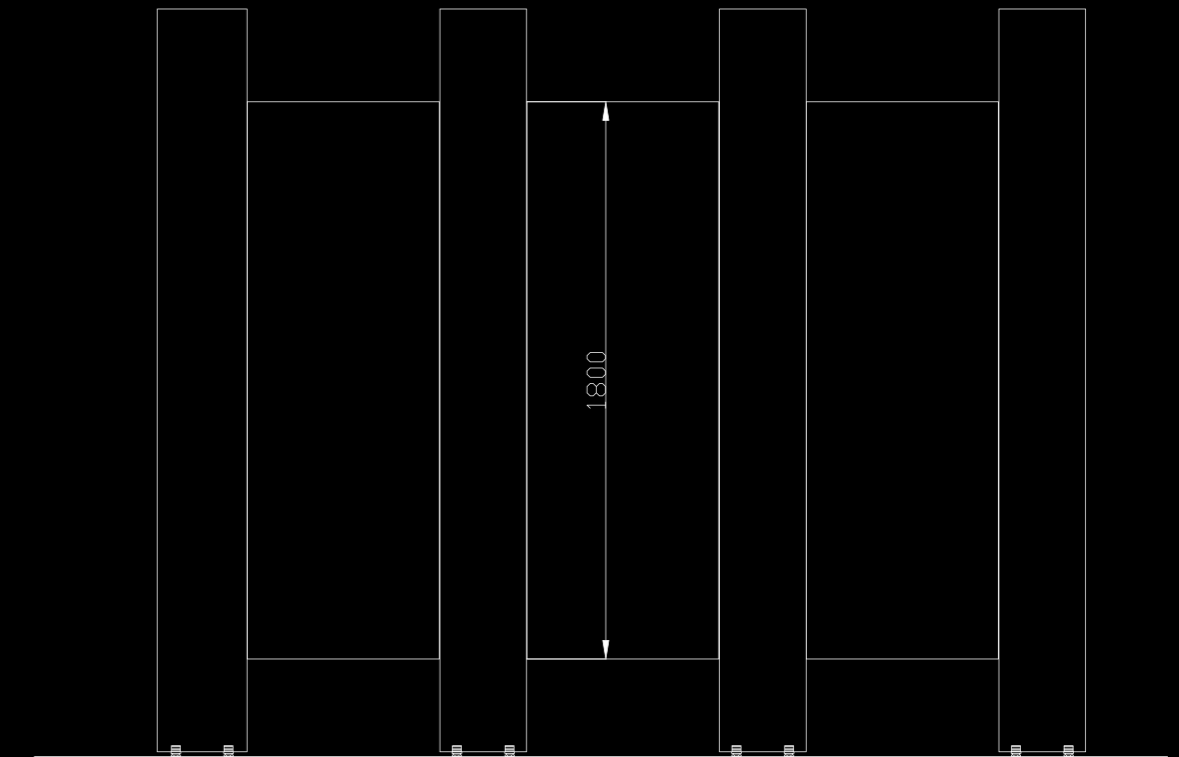

Polígono Industrial El Carrascot
Calle Els Fusters s/n
46850 / l'Olleria / Valencia
Spain - Espagne - España

T. +34 962 208 456
F. +34 962 208 097
liberfusta@liberfusta.com
www.liberfusta.com

