



SYSKOR

aluminium systems



www.syskor.es



SYSKOR

air program

soluciones para puertas de paso

carril a pared y carril a techo

rooms divisions solutions

top track to wall and top track to ceiling

carril a pared top track to wall

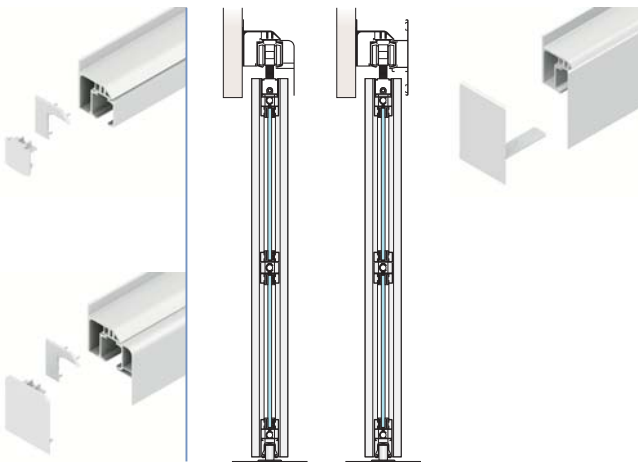

1 puerta - carril individual a pared
1 door - single track to wall

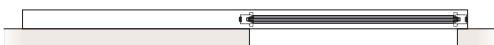

2 puertas - carril individual a pared
2 doors - single track to wall

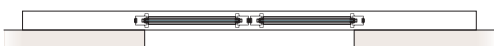

carril a techo top track to ceiling

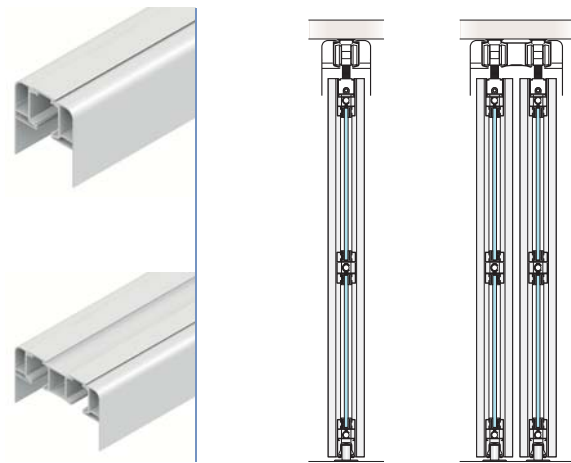

1 puerta - carril individual a techo
1 door - single track to ceiling

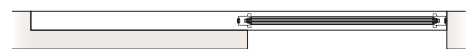

2 puertas - carril doble a techo
2 doors - double track to ceiling

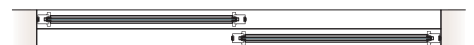

3 puertas - carril doble a techo
3 doors - double track to ceiling

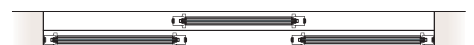

4 puertas - carril doble a techo
4 doors - double track to ceiling

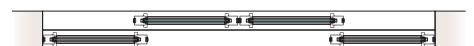

puertas de aluminio en acabado **plata mate**
para tablero de 10 mm y cristal de 3/4 y 5/6 mm

silver matt aluminium doors

10 mm board and 3/4 and 5/6 mm glass

air
program

RODADURAS / WHEELS



rodadura / wheel **C-130-RA**
retenedor autocierre
soft closing retainer



rodadura / wheel **C-130-R**



rodadura / wheel **C-60-R**



tirador PCT
perfil vertical
vertical profile

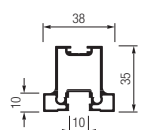

embellecedor
superior inferior
perfil horizontal "U"
"U" horizontal profile

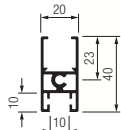

embellecedor
japonesa
perfil horizontal "H"
"H" horizontal profile

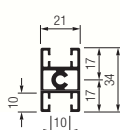

altura máxima 2,9 metros
max. height 2,9 meters

Un programa de fácil montaje y con un novedoso **sistema patentado de regulación lateral**, para un ajuste preciso y un funcionamiento óptimo. Varias versiones para **puertas de aluminio y madera hasta 60 y 130 Kgs** y cierre automático.

*This easy to fit program includes a new **patented side regulation system** for optimal adjustment and smooth functioning.*

*For **doors up to 60 and 130 Kgs** and with or without soft close damping mechanism.*



SYSKOR



SYSKOR

terra program
serie max 60
max 60 series

S75 · carril alto de 75 mm · tablero de 10 mm

S85 · carril alto de 85 mm · tablero de 16 mm

S75 · 75 mm top track · 10 mm panels

S85 · 85 mm top track · 16 mm panels

tiradores
vertical profiles

TR10-MAX60



TR16-MAX60



perfiles "H"
"H" profiles

PRH10-MAX60



PRH16-MAX60

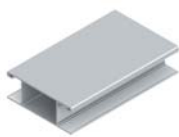

perfil lateral uñero
side profile

PLU15



Perfiles anchos de estilo contemporáneo con acabados en **anodizado, melamina, alto brillo y chapa natural**.

Sistema de rodadura con ruedas de 60 mm de diámetro y de un funcionamiento suave y silencioso, incluso en puertas de 70 Kg de peso.

Wide contemporary linear style profiles for bedrooms, living rooms and kitchens. Heavy duty oversized rollers for an smooth and silent operation even on heavy doors up to 70 Kgs.



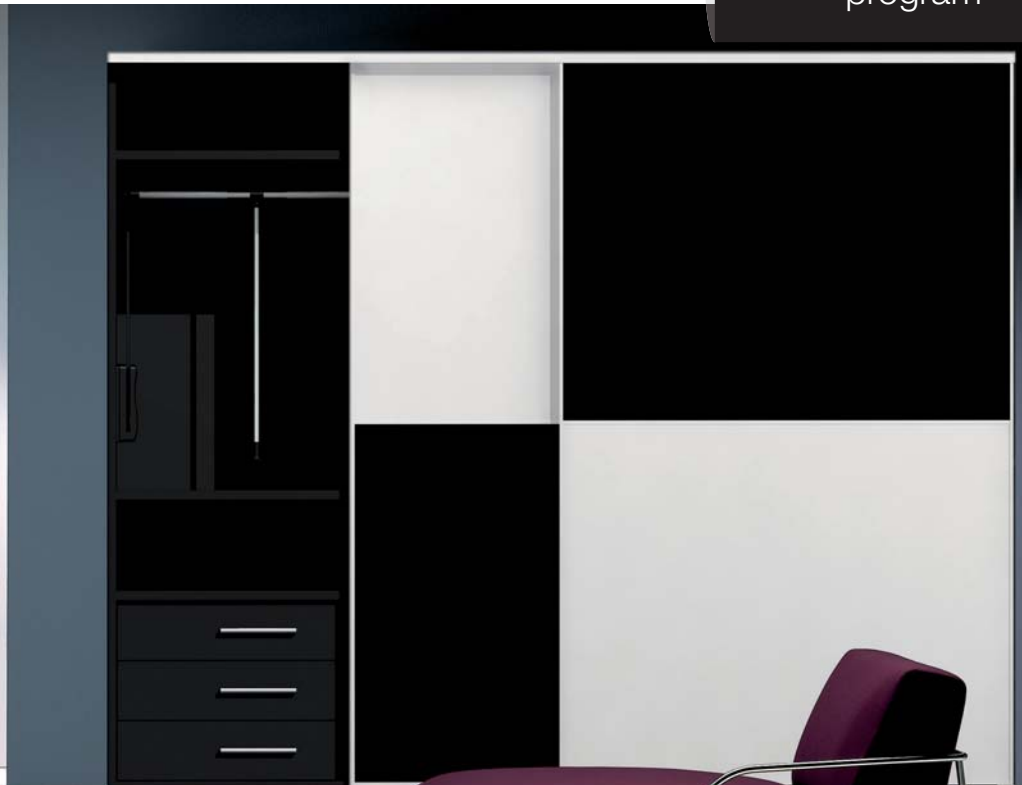



SYSKOR

terra program
 serie minimal
 minimal series

- S75** · carril alto de 75 mm · tablero de 10 mm
- S85** · carril alto de 85 mm · tablero de 16 mm
- S75** · 75 mm top track · 10 mm panels
- S85** · 85 mm top track · 16 mm panels

Perfiles de estilo minimalista para dormitorios, salones y cocinas. Una completa gama de acabados en anodizados, lacados, revestimientos en alto brillo, melaminas y chapa natural.

Minimalist style profiles for modern designs and combinations. More than 20 different finishes in high gloss wrapping, veneer or anodizes for a brilliant look.

tiradores vertical profiles TR10V1  TR16V1-S85 	tiradores vertical profiles TR10V2  TR16V2-S85 	tiradores vertical profiles TR10V7  TR16V7-S85 	tiradores vertical profiles TR16V4-S85  TR16V4-S85 	perfiles "U" "U" profiles PRU10V  PRU16V-S85 	perfiles "H" "H" profiles PRH10V  PRH16V-S85 
---	---	---	---	---	---

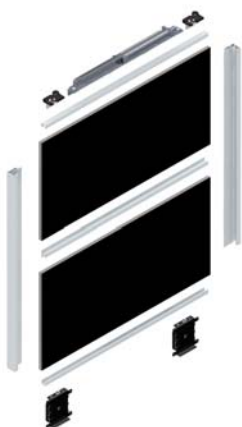

perfil c vertical c vertical profile TR10V3  TR10V3-S85 
--

Diseños únicos y gran número de combinaciones con el nuevo perfil central vertical V3 perfil refuerzo support profile PRZ-50 

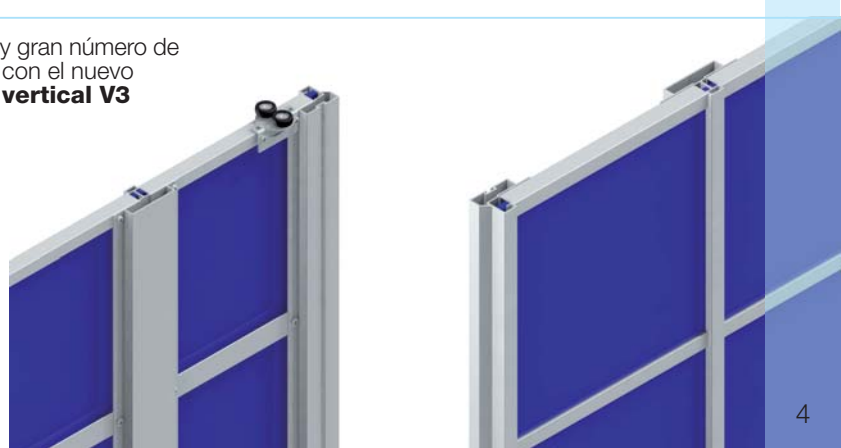



SYSKOR

terra program
serie classic
classic series

S75 · carril alto de 75 mm · tablero de 10 mm
S85 · carril alto de 85 mm · tablero de 16 mm
S75 · 75 mm top track · 10 mm panels
S85 · 85 mm top track · 16 mm panels

tiradores
vertical profiles

TR10
TR16
TR16-S85



tirador
vertical profile

TR10CS



tirador
vertical profile

TR10KB



tiradores
vertical profiles

TR10ML
TR16ML
TR16ML-S85



tiradores
vertical profiles

TR10RD
TR16RD
TR16RD-S85



tirador
vertical profile

TR10DC



tirador
vertical profile

TR10ND



perfil "U"
"U" profile

PRU10
PRU16



perfil "H"
"H" profile

PRH10
PRH16



perfil "H"
"H" profile

PRH10-1025



perfil faldón
"H" profile

PRF10
PRF16



Una línea completa de **perfiles clásicos y contemporáneos**, en 26 diferentes acabados (anodizado, pintura, melamina y chapa natural). Para tableros de 10 y 16 mm.

A complete line of **classic and contemporary designs** in 26 finishes for 10 and 16 mm board.

TR19-S85 · carril alto de 85 mm · **tablero de 19 mm**
TR19-S85 · 85 mm top track · **19 mm panels**

terra
program



Nueva familia de perfiles que complementa el programa **terra S-85** para la confección de puertas con **tablero de 19 mm**, de estética adecuada a las actuales tendencias, disponible en acabado aluminio plata mate.

This new modern looking profile is specifically designed for 18/19 mm board and is compatible with the current 85 mm top and bottom tracks and wheels.

tirador
vertical profile

TR19-S85

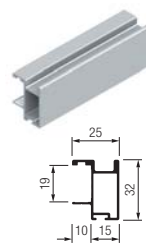

perfil "U"
"U" profile

PRU19-S85

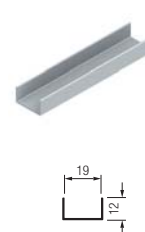

perfil "H"
"H" profile

PRH19-S85

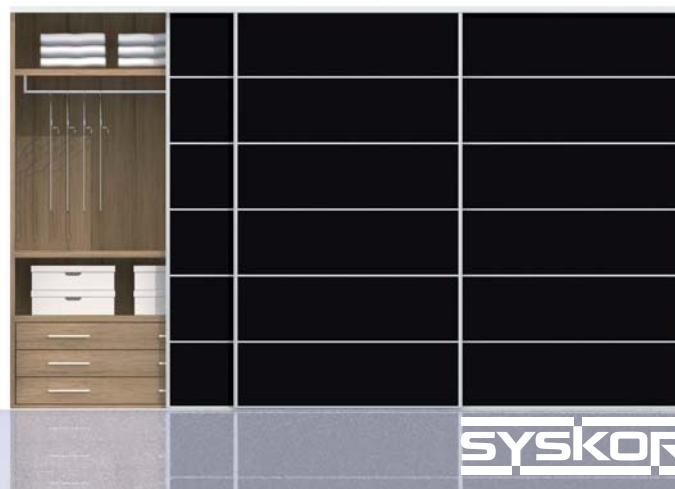

terra program

carriles, ruedas y retenedores autocierre
wheels, tracks and soft closing dampers



Gama variada de carriles para todo tipo de configuraciones y necesidades.
Single, double and triple tracks for all needs.

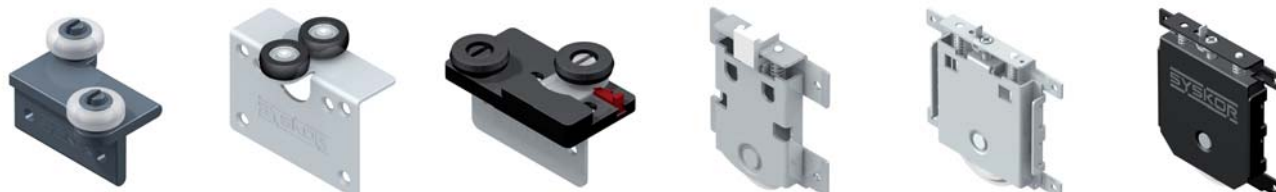

Rodaduras con ruedas de 60 mm de diámetro, de funcionamiento suave y silencioso, incluso en puertas de 60 Kg de peso.
 Rodamientos **sellados de alta precisión**. Mecanismo **antidescarrilamiento de doble muelle**.
Heavy duty top and bottom wheels with sealed ball bearings.



Sistemas de retenedores autocierre para diferentes pesos de puerta que garantizan un cierre suave y de larga duración.
Soft closing dampers for all kind of doors weights for a smooth and reliable functioning.



base program

S80 · carril alto de 80 mm · tablero de 10 mm
S80 · 80 mm top track · 10 mm panels

carril alto
top track
CA-BASE



carril bajo
bottom track
CB-BASE



tirador
vertical
profile
TR-BASE25



tirador
vertical
profile
TR-BASE55



perfil inferior
bottom profile
RI-BASE



perfil superior
upper profile
RS-BASE



perfil central
central profile
RC-BASE



Un único sistema válido tanto para **puertas de armarios como para pasos de puerta**. Dos modernos perfiles (minimalista y "maximal") para puertas con paneles en madera o cristal.

A unique modern looking program with a **maximun frame rigidity** to be used in wardrobes, walk in closets and **room divisions**.



CONJUNTO DE RUEDAS / ROLLERS COMPLETE SET

rueda superior
rodamiento
upper roller
ballbearings



rueda inferior Ø40
bottom roller Ø40



tornillos M6x30
bolts M6x30



**CONJ. RETENEDORES
SOFT CLOSING
RETAINER SET**

izquierdo left derecho right



ACCESORIOS / ACCESSORIES

perfil PVC lateral
PVC side profile

goma "U" para
cristal de 4 mm
"U" fitting for 4
mm glass

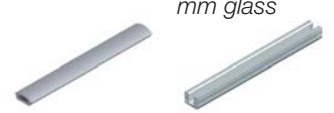

molduras MDF para frentes de armario

MDF moldings for wardrobes doors

molduras
program

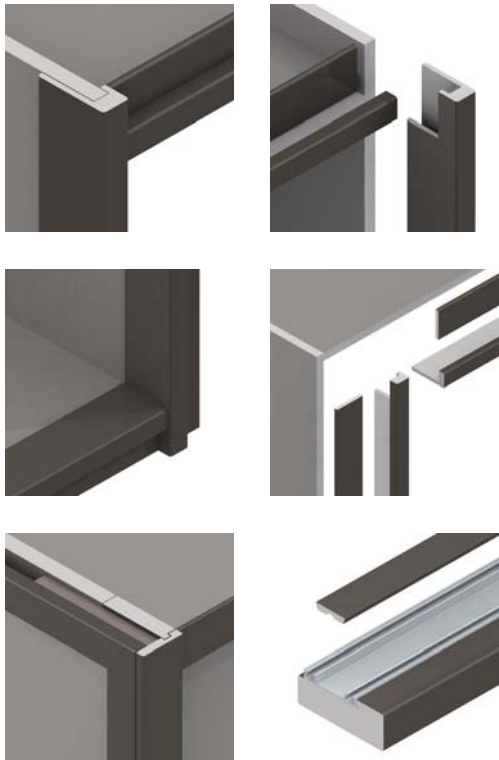

Remates para frentes de armarios a través de una **variada y funcional gama de molduras** en MDF, disponibles en una amplia gama de acabados.

A complete **MDF line of moldings in all wrappings** for a perfect finish of the wardrobe front.

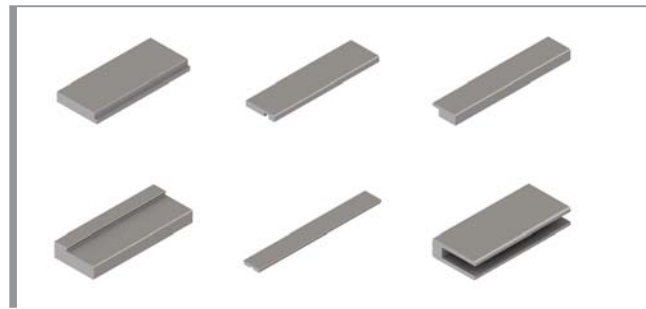

acabados finishes

acabado aluminio

A01 lacado blanco white lacquer	A02 plata mate matt silver	A03 oro mate repulido matt gold polished	A04 bronce mate repulido matt bronze polished	A10 oro brillo repulido sheen gold polished	A11 lacado inox lacqued stainless steel	A31 plata brillo químico brilliant silver
--	---	---	--	--	--	--

lacqued & anodized finish

chapa sin barnizar

C01 roble s/h oak s/b	C02 sapelly s/h sapelly s/b	C03 fresno s/h ash s/b	C04 cerezo s/h cherry tree s/b	C05 haya s/h beech s/b	C06 pino s/h pine s/b	C07 haya vaporizada s/h steamed beech s/b
------------------------------------	--	-------------------------------------	---	-------------------------------------	------------------------------------	--

veneer wrappings (not varnished)

papel melamina

P02 roble claro A-412 clear oak A-412	P03 sapelly D-468 sapelly D-468	P04 pino C-419 pine C-419	P05 cerezo H-450 cherry tree H-450	P06 haya vaporizada H-428 stem beech H-428	P07 roble oscuro A-725 dark oak A-725	P08 cerezo tajo H-2428 cherry tree tajo H-2428
--	--	--	---	---	--	---

melamine wrappings

P09 wengue congo D-0427 wengue congo D-0427	P84 blanco W-402 white W-402	P92 plata LY-2609 silver LY-2609
--	---	---

acabados especiales

special high gloss wrappings

R01 blanco alto brillo high gloss white	R02 negro alto brillo high gloss black
--	---

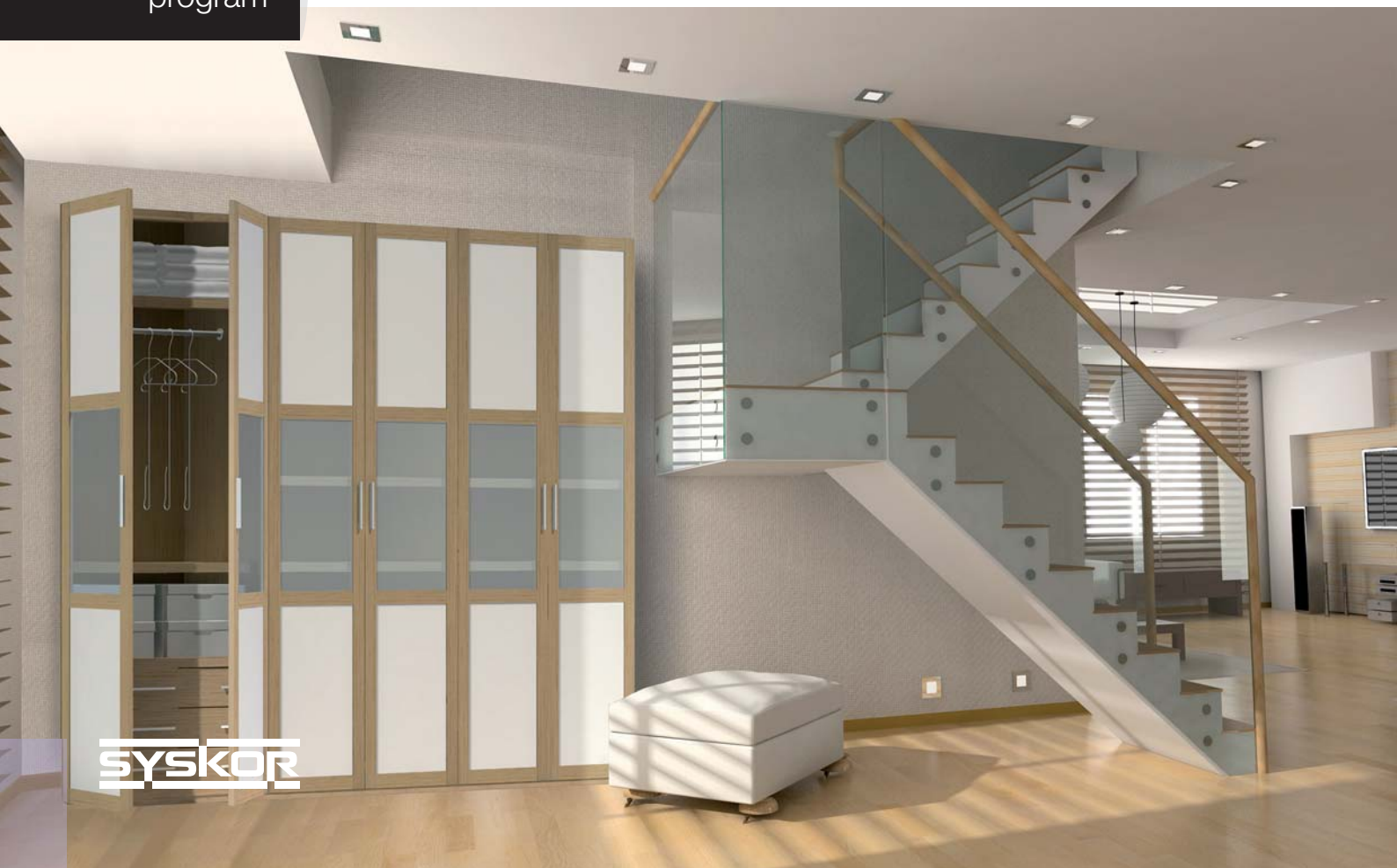

axis program
serie max 60
max 60 series

perfiles de aluminio para tablero de 10 mm
aluminium profiles for 10 mm board

Un programa de **perfiles anchos** que permiten el montaje de puertas batientes con paneles de madera o cristal y **gran variedad de diseños y estilos.**

Montaje fácil y rápido, tanto en corte recto como en inglete.

Wide contemporary profiles allowing the assembly of aluminium hinged doors with wood and glass panels.

This easy to assemble system can be cutted in 90° or miter cut.

tirador vertical profile
TB60



perfil "H"
"H" profile
PHB60



ESCUADRA para corte recto
90° fixing bracket



ESCUADRA para corte en inglete
miter joint fitting



GOMA para cristal 4 mm transparente
transparent fitting for 4 mm glass



corte en inglete
miter cut



corte recto
90° cut





axis program
 serie minimal
minimal series

perfiles de aluminio para tablero de 10 mm
***aluminium profiles** for 10 mm board*

Línea de **perfiles de corte minimalista** que permite el montaje de puertas batientes con paneles de madera o cristal y **gran variedad de diseños y estilos.**

Montaje fácil y rápido, tanto en corte recto como en inglete.

Minimalist modern looking profiles allowing the assembly of aluminium hinged doors with wood and glass panels.

This easy to assemble system can be cutted in 90° or miter cut.

tirador vertical profile TBMV1 	perfil "U" "U" profile PRU10V 	perfil "H" "H" profile PRH10V 	ASA 150 mm handle profile 150 mm 	ASA 2,6 m handle profile 2,6 m 
---	---	--	--	--

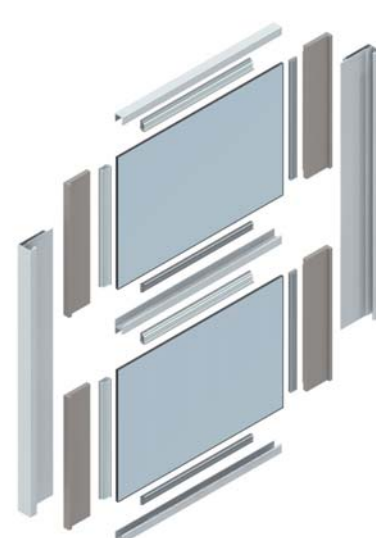

ESCUADRA para corte en inglete miter joint fitting 	MIN10 moldura para cristal 4 mm molding for 4 mm glass 	GOMA para cristal 4 mm transparente transparent fitting for 4 mm glass 
--	---	---

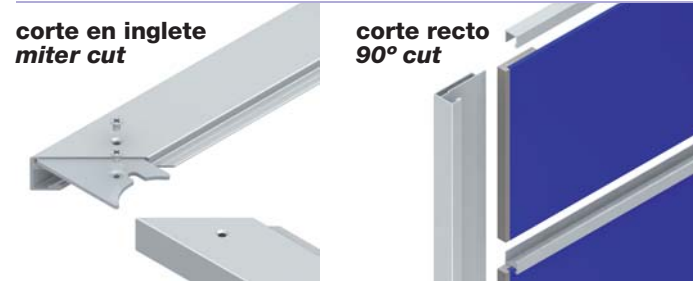



SYSKOR



comfort program

soluciones para interiores de armario
storage solutions for wardrobes



Una completa línea de **pantaloneros, zapateros, elevadores, corbateros,...** con los máximos estándares de calidad y funcionalidad.

A complete line of trouser racks, tie racks, hangers and shoes racks,... up to the highest quality standards.



conecta program

spot & quadro profile

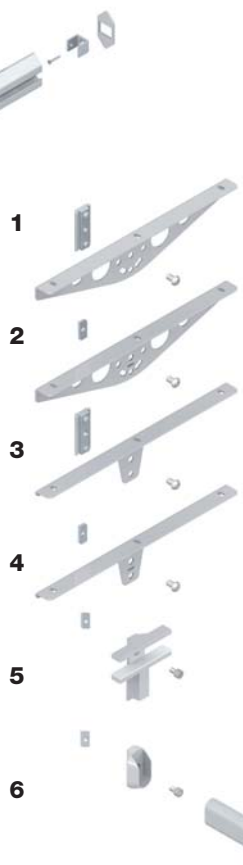

1 soporte balda "classic" inclinable
adjustable shelf support "classic"

2 soporte balda "classic" fija (fijación frontal directa)
non adjustable shelf support "classic" (add on direct fixing)

3 soporte balda "mini" fija
non adjustable shelf support "mini"

4 soporte balda "mini" fija (fijación frontal directa)
non adjustable shelf support "mini" (add on direct fixing)

5 soporte balda mordaza (fijación frontal directa)
horizontal shelf support for glass (add on direct fixing)

6 soporte lateral para barra (fijación frontal directa)
hanging bar support (add on direct fixing)

spot profile

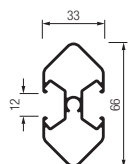

quadro profile

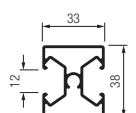

Syskor presenta su **programa modular de estanterías**, de estética contemporánea, muy versátil y de fácil colocación (altura máxima 2,7 metros).

Syskor presents the most **versatile aluminium storage program** very functional and easy to assemble (max. height 2,7 meters).



SYSKOR

silence program

perfiles de aluminio para cabeceros de cama
tablero de 10 mm

aluminium profiles for beds headboards
10 mm panels

perfil
profile

SL55



perfil "H"
"H" profile

PRH10V



perfil "H"
"H" profile

PRH10-1020



ESCUADRA
45x45
fixing plate
45x45



CB5019
moldura regleta
fijación a pared
molding for wall
fixing



MIN10
moldura para
cristal 4 mm
molding for 4
mm glass



GOMA para cristal
4 mm transparente
transparent fitting
for 4 mm glass

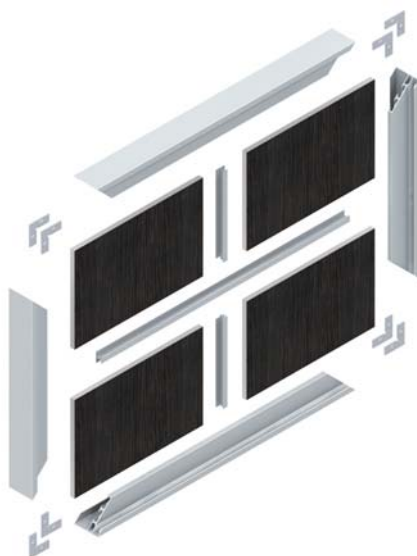

Línea de **perfiles de aluminio de estilo minimalista**
para el montaje de cabeceros de cama con paneles de
madera y cristal.

Minimalist style aluminium profiles for bed
headboards with panels of wood or glass.

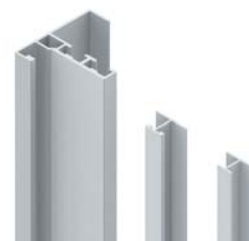

air program

puertas correderas colgantes de paso *top hung sliding doors*

carril a pared *top track to wall*
carril a techo *top track to ceiling*



terra program

puertas correderas apoyadas *floor supported sliding doors*

S75 carril alto 75 mm *top track* · tablero 10 mm *panels*
S85 carril alto 85 mm *top track* · tablero 16 mm *panels*

serie max-60
serie minimal
serie classic
TR19-S85



base program

sistema de puerta corredera con rueda oculta *bottom hidden wheels system*

S80 carril alto 80 mm *top track* · tablero 10 mm *panels*



molduras program

molduras MDF para frentes de armario *MDF moldings for wardrobes doors*

axis program

puertas batientes *hinged doors*

tablero de 10 mm
10 mm *panels*

serie max-60
serie minimal



comfort program

accesorios para el interior de armario *accessories for wardrobes*



conecta program

programa modular de estanterías *storage system*

spot profile
quadro profile



silence program

cabeceros de cama *beds headboards*

tablero de 10 mm
10 mm *panels*



international shows



Valencia
Spain



Köln
Germany



Bad Salzuffen
Germany



SYSKOR
aluminium systems



SYSKOR
is certified
ISO 9001

Syskor Sistemas de Perfiles S.L. es una de las compañías líderes en España en la fabricación y comercialización de **sistemas integrales de aluminio**.

Con un conocimiento profundo del producto, dedica la máxima atención a garantizar el mejor servicio a sus clientes, apostando por el **diseño y la innovación como estrategia permanente**.

Nuestras instalaciones de 7.000 metros cuadrados están localizadas en las proximidades de Vitoria, con excelentes comunicaciones a toda la península.

Syskor Sistemas de Perfiles S.L. is one of the leading spanish companies for the design, manufacture and distribution of **aluminium sliding door systems for wardrobes**.

Our new 7.000 square meters headquarters are located near the city of Vitoria at the north of Spain with excellent communications to Spain and all Europe.



SYSKOR SISTEMAS DE PERFILES S.L.

Polígono Industrial Goiaín

Calle San Blas, 6A

01170 · Legutiano · Álava · SPAIN

T +34 945 466 311 · F +34 945 465 77

e-mail: syskor@syskor.es

www.syskor.es

