

TARIFA PREFABRICADOS PVP 2.017

CODIGO	FAMILIA	SUBFAMILIA	PRODUCTO	CC	PVP 2017
--------	---------	------------	----------	----	----------

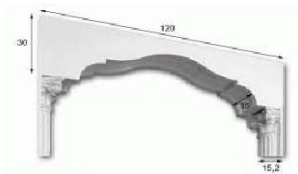

*Prefabricados
y decoración
de escayola*



EN VIGO.-
Camiño da Feira nº 3 - Nave 2-A
Bembrive (en frente Tanatorio Vigo Memorial)
986 40 61 84
vigo@galuso.gal

Galuso
Almacéns de Solucións Constructivas
www.galuso.gal

EN OURENSE.-
Carretera de Vigo nº 30
Quintela de Canedo
988 21 26 83
ourense@galuso.gal

TARIFAS 2017
PREFABRICADOS Y DECORACION
DE ESCAYOLA

www.galuso.gal

TARIFA PREFABRICADOS PVP 2.017

CODIGO	FAMILIA	SUBFAMILIA	PRODUCTO	CC	PVP 2017
--------	---------	------------	----------	----	----------

PLACAS DE TECHO FIJO

UD

11001001	1000	1001	PLACA LISA RASEADA EL PINAR - 100X60 - Ud.-	1	2,46
11002001	1000	1001	PLACA LISA RASEADA PREF. VALERIO - 100X60 - Ud.-	1	2,70

ESPARTOS

UD

10101010	1000	1010	RUEDA ESPARTO MEZCLA	1	23,70
10101020	1000	1010	RUEDA ESPARTO BLANCO (SISAL)	1	29,00

TABIQUES DE ESCAYOLA

M2

13001206	1000	1030	TABIQUE 6 CM. - M2.-	0,333	22,54
13001207	1000	1030	TABIQUE 7 CM. - M2.-	0,333	25,01
13001208	1000	1030	TABIQUE 8 CM. - M2.-	0,333	29,77
13002208	1000	1030	TABIQUE 8 CM. - PERFORADO - M2.-	0,25	29,18

TABIQUES CERAYESO



M2

11005006	1000	1100	TABIQUE CERAYESO 6 CM - 95x36 - M2 - PALET 14 M2	0,35	25,31
11005008	1000	1100	TABIQUE CERAYESO 8 CM - 95x36 - M2 - PALET 14,36 M2	0,35	29,82
11005010	1000	1100	TABIQUE CERAYESO 10 CM - 95x33 - M2 - PALET 10,34 M2	0,32	35,70

FOSAS DE ESCAYOLA

ML

12120001	1000	1060	CANAL OSCURO 4X4X10 (FOSA) - 1,20 M	1,2	3,20
12120200	1000	1060	CANAL OSCURO 4X4 - 1,20 M	1,2	2,64
12120201	1000	1060	CANAL OSCURO 3X5 - 1,10 M	1,1	2,48
12120202	1000	1060	CANAL OSCURO 4X4X4 - 1,20 M	1,2	3,26
12120204	1000	1060	CANAL OSCURO 4X4X30 - 1,20 M	1,2	4,30

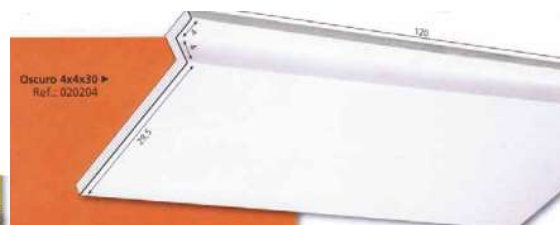

TARIFA PREFABRICADOS PVP 2.017

CODIGO	FAMILIA	SUBFAMILIA A	PRODUCTO	CC	PVP 2017
<u>CORTINEROS</u>					<u>ML</u>
12132010	1000	1060	CORTINERO Nº 2 - 10 X 10		6,73
12132015	1000	1060	CORTINERO Nº 1 - 10 X 15		7,21
12132020	1000	1060	CORTINERO Nº 0 - 10 X 20		7,74



BANDEJAS

CODIGO	FAMILIA	SUBFAMILIA A	PRODUCTO	CC	PVP 2017
<u>BANDEJAS</u>					<u>ML</u>
12130120	1000	1060	BANDEJA 20 X 4 - 1,20 M		9,39
12130130	1000	1060	BANDEJA 30 X 4 - 1,20 M		9,58
12130140	1000	1060	BANDEJA 40 X 4 - 1,20 M		9,74



TARIFA PREFABRICADOS PVP 2.017

CODIGO	FAMILIA	SUBFAMILIA	PRODUCTO	CC	PVP 2017
--------	---------	------------	----------	----	----------

MOLDURAS DE ESCAYOLA















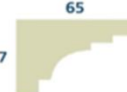









ML

12003001	1000	1020	MOLDURA Nº 1 - (Nº 3-B VALERIO) - 1,25 M		1,32
12003002	1000	1020	MOLDURA Nº 2 - (Nº 16 VALERIO) - 1,25 M		1,52
12003003	1000	1020	MOLDURA Nº 3 - (Nº 3 VALERIO) - 1,25 M		1,32
12003004	1000	1020	MOLDURA TACO - (Nº 14 VALERIO) - 1,25 M		1,32
12003005	1000	1020	MOLDURA DOBLE TACO - (Nº 6 VALERIO) - 1,25 M		1,32
12003006	1000	1020	MOLDURA Nº 6 - (Nº 8 VALERIO) - 1,20 M		1,32
12003009	1000	1020	MOLDURA Nº 9 - (Nº 9 VALERIO) - 1,25 M		1,32
12003010	1000	1020	MOLDURA Nº 10 - (Nº 5 VALERIO) - 1,25 M		1,32
12003013	1000	1020	MOLDURA Nº 13 - 1,25 M (TRES CANTOS EL PINAR) - 1,25 M		1,32
12003015	1000	1020	MOLDURA Nº 15 - (Nº 7 VALERIO) - 1,20 M		1,32
12003016	1000	1020	MOLDURA Nº 16 - (Nº 13 VALERIO) - 1,25 M		1,32
12003007	1000	1020	MOLDURA Nº 103-B - (Nº 5-B VALERIO) - 1,25 M		1,32
12003011	1000	1020	MOLDURA Nº 17-P - (Nº 17-B VALERIO) - 1,25 M		1,76
12003012	1000	1020	MOLDURA Nº 17-G - (Nº 17 VALERIO) - 1,25 M		1,76
12003014	1000	1020	MOLDURA R (MOLDURA Nº 32 EL PINAR) - 1,05		1,98
12003008	1000	1020	MOLDURA M-A - (Nº 18-D EL PINAR) - 1,25 M		1,76
12003019	1000	1020	MOLDURA Nº 19 - (Nº 24-B VALERIO) - 1,25 M		2,55
12003020	1000	1020	MOLDURA Nº ESC. PEQUEÑA - (Nº 21 VALERIO) - 1,25 M		1,32
12003021	1000	1020	MOLDURA Nº ESC. MEDIANA - (Nº 22 VALERIO) - 1,25 M		1,32
12003022	1000	1020	MOLDURA Nº ESC. GRANDE - (Nº 23 VALERIO) - 1,25 M		1,76

12003001	MOLDURA Nº 1 - (Nº 3-B VALERIO) - 1,25 M		1,32
12003002	MOLDURA Nº 2 - (Nº 16 VALERIO) - 1,25 M		1,52
12003003	MOLDURA Nº 3 - (Nº 3 VALERIO) - 1,25 M		1,32
12003004	MOLDURA TACO - (Nº 14 VALERIO) - 1,25 M		1,32
12003005	MOLDURA DOBLE TACO - (Nº 6 VALERIO) - 1,25 M		1,32
12003006	MOLDURA Nº 6 - (Nº 8 VALERIO) - 1,20 M		1,32
12003009	MOLDURA Nº 9 - (Nº 9 VALERIO) - 1,25 M		1,32

Página

TARIFA PREFABRICADOS PVP 2.017

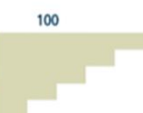
CODIGO	FAMILIA	SUBFAMILIA	PRODUCTO	CC	PVP 2017
12003010		A	MOLDURA Nº 10 - (Nº 5 VALERIO) - 1,25 M  	48 58	<u>1,32</u>
12003013			MOLDURA Nº 13 - (Nº 20 VALERIO) - 1,25 M  	47 65	<u>1,32</u>
				MOLDURA Nº 18 - PLACO	
12003015			MOLDURA Nº 15 - (Nº 7 VALERIO) - 1,20 M  	33 46	<u>1,32</u>
				MOLDURA Nº 7 - PLACO	
12003016			MOLDURA Nº 16 - (Nº 13 VALERIO) - 1,25 M  	42 45	<u>1,32</u>
12003007			MOLDURA Nº 103-B - (Nº 5-B VALERIO) - 1,25 M  	43 67	<u>1,32</u>
				MOLDURA Nº 103-B - PLACO	
12003011			MOLDURA Nº 17-P - (Nº 17-B VALERIO) - 1,25 M  	48 80	<u>1,76</u>
12003012			MOLDURA Nº 17-G - (Nº 17 VALERIO) - 1,25 M  	60 100	<u>1,76</u>
				MOLDURA Nº 17-G - PLACO	
12003014			MOLDURA R (MOLDURA Nº 32 EL PINAR) - 1,05  	65 56	<u>1,98</u>
12003008			MOLDURA M-A - (Nº 12 VALERIO) - 1,25 M  	60 80	<u>1,76</u>
				MOLDURA Nº 18-D - PLACO	
12003020			MOLDURA Nº ESC. PEQUEÑA - (Nº 21 VALERIO) - 1,25 M  	30 45	<u>1,32</u>
12003021			MOLDURA Nº ESC. MEDIANA - (Nº 22 VALERIO) - 1,25 M  	40 60	<u>1,32</u>
12003022			MOLDURA Nº ESC. GRANDE - (Nº 23 VALERIO) - 1,25 M  	50 100	<u>1,76</u>

Página

TARIFA PREFABRICADOS PVP 2.017

CODIGO	FAMILIA	SUBFAMILIA A	PRODUCTO	CC	PVP 2017
MOLDURAS EL ALTERON					ML
12020101	1000	1060	MOLDURA Nº 1 - 1,20 M		1,88
12020102	1000	1060	MOLDURA Nº 2 - 1,20 M		1,88
12020103	1000	1060	MOLDURA Nº 3 - 1,20 M		1,88
12020104	1000	1060	MOLDURA Nº 4 - 1,20 M		2,24
12020105	1000	1060	MOLDURA Nº 5 - 1,20 M		2,36
12020106	1000	1060	MOLDURA Nº 6 - 1,20 M		2,75
12020107	1000	1060	MOLDURA Nº 7 - ONDAS - 1,20 M		2,24
12020108	1000	1060	MOLDURA Nº 8 - 1,20 M		1,72
12020109	1000	1060	MOLDURA Nº 9 - 1,20 M		2,35
12020110	1000	1060	MOLDURA Nº 10 - 1,20 M		2,35
12020111	1000	1060	MOLDURA Nº 11 - 1,20 M		2,24
12020112	1000	1060	MOLDURA Nº 12 - 1,20 M		2,64
12020113	1000	1060	MOLDURA Nº 13 - 1,20 M		2,86
12020116	1000	1060	MOLDURA Nº 16 - 1,20 M		1,52
12020117	1000	1060	MOLDURA Nº 17 - 1,20 M		2,36
12020118	1000	1060	MOLDURA Nº 18 - 1,20 M		2,36
12020119	1000	1060	MOLDURA Nº 19 - 1,20 M		2,24
12020120	1000	1060	MOLDURA Nº 20 - 1,20 M		2,36
12020121	1000	1060	MOLDURA Nº 21 - 1,20 M		1,76
12020122	1000	1060	MOLDURA Nº 22 - 1,20 M		1,76
12020123	1000	1060	MOLDURA Nº 23 - 1,20 M		1,88
12020124	1000	1060	MOLDURA Nº 24 LAUREL - 1 M		2,24
12020125	1000	1060	MOLDURA Nº 25 - 1,20 M		2,36
12020126	1000	1060	MOLDURA Nº 26 - 1,20 M		2,64
12020127	1000	1060	MOLDURA Nº 27 - 1,20 M		2,35
12020128	1000	1060	MOLDURA Nº 28 - 1,20 M		3,50
12020161	1000	1060	MOLDURA RAMITOS - 1,20 M		2,36
12020162	1000	1060	MOLDURA HOJITAS - 1,20 M		2,36
12020163	1000	1060	MOLDURA FRISO VEGETAL - 1 M		2,36
12020211	1000	1060	TIRA LISA Nº 1 - 7.8 X 1,5 X 1,23		2,75
12020212	1000	1060	TIRA LISA Nº 2 - 5 X 2 X 1,205		2,75
					
12020701	1000	1060	MOLDURA ESCALÓN MÚLTIPLE 3X4 - 1,20 M		2,27
12020702	1000	1060	MOLDURA ESCALÓN MÚLTIPLE 6X4 - 1,20 M		2,35
12020703	1000	1060	MOLDURA ESCALÓN MÚLTIPLE 10X5 - 1,20 M		2,64

TARIFA PREFABRICADOS PVP 2.017

CODIGO	FAMILIA	SUBFAMILIA	PRODUCTO	CC	PVP 2017
--------	---------	------------	----------	----	----------

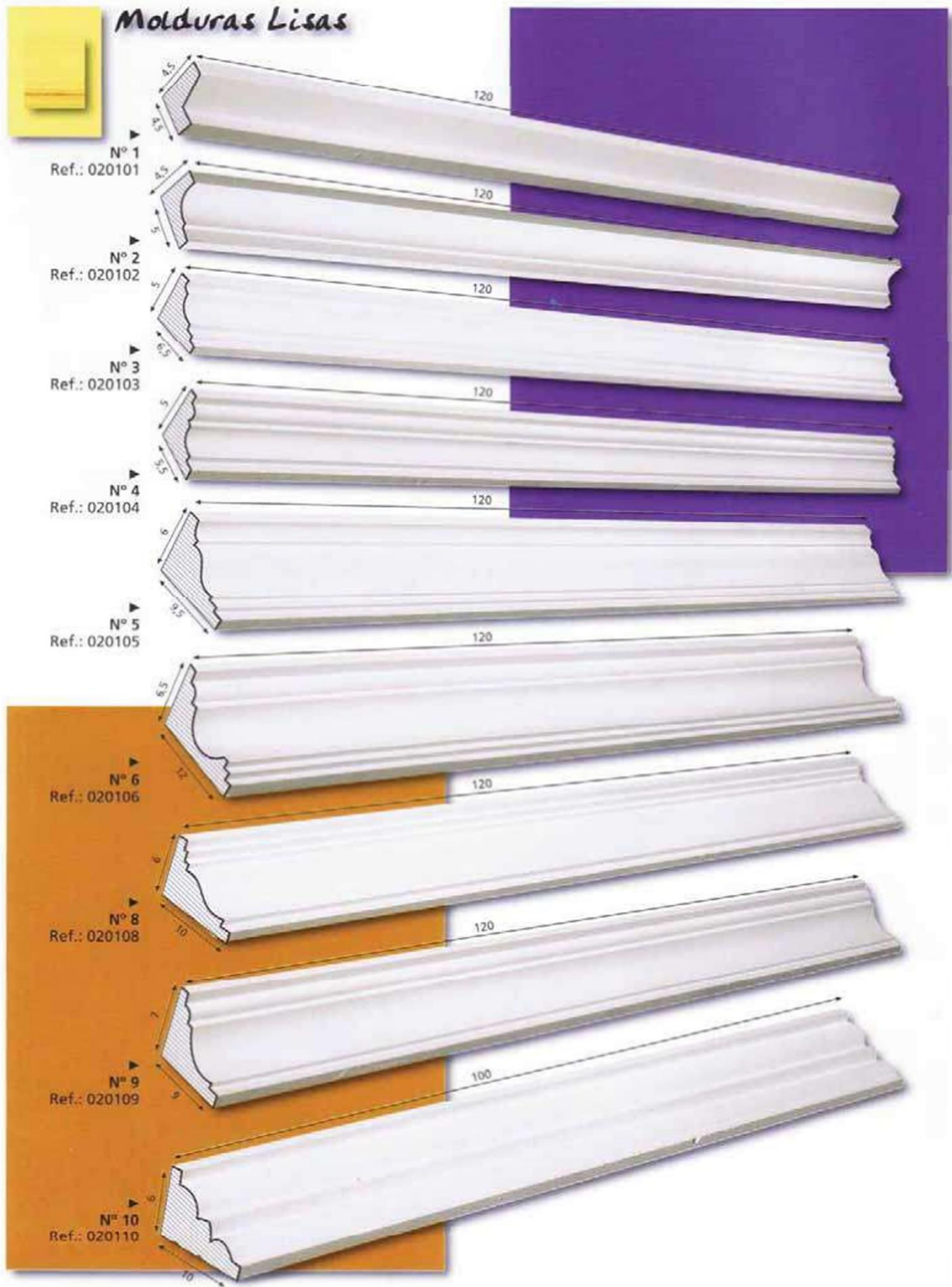

TARIFA PREFABRICADOS PVP 2.017

CODIGO	FAMILIA	SUBFAMILIA A	PRODUCTO	CC	PVP 2017
--------	---------	-----------------	----------	----	----------



TARIFA PREFABRICADOS PVP 2.017

CODIGO	FAMILIA	SUBFAMILIA	PRODUCTO	CC	PVP 2017
BOVEDAS Y VIGAS DE ESCAYOLA					UD
16070703	1000	1060	BÓVEDA - 57,5 X 7,5 X 104		25,12
16080107	1000	1060	VIGA Nº 1 - 13,5 X 5 X 100		15,00
16080108	1000	1060	VIGA Nº 2 - 13 X 6,5 X 100		15,00
16080110	1000	1060	VIGA Nº 3 - 13 X 7 X 109		14,96
16080109	1000	1060	VIGA Nº 2 - 13 X 6,5 X 126		14,96



REJILLAS Y TAPAS DE REGISTRO

16070701	1000	1060	REJILLA VENTILACIÓN Nº 2 - 28,5 X 28,5		19,58
16070702	1000	1060	REJILLA VENTILACIÓN Nº 1 - 59 X 59		45,83
16070030	1000	1060	TAPA REGISTRO Nº 1 - 63,5 X 64		55,75
16070031	1000	1060	TAPA REGISTRO Nº 2 - 35 X 35		46,78
16070306	1000	1060	REGISTRO VENTILACIÓN Nº 2 - 35 X 35		50,70
16070702	1000	1060	NICHO CEMENTERIO 72X70X1,02X74		33,42

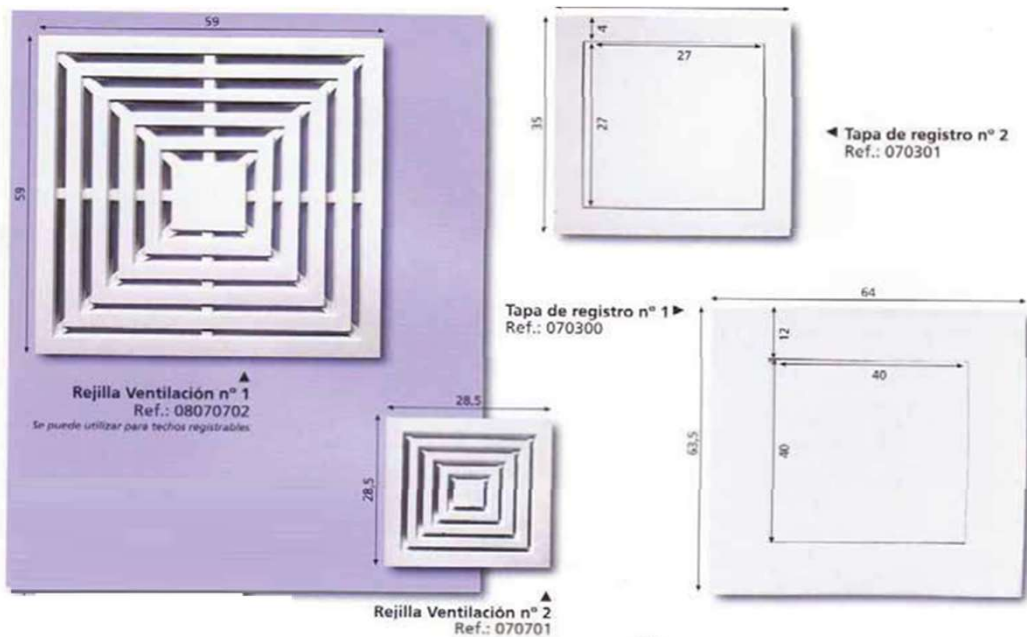

TARIFA PREFABRICADOS PVP 2.017

CODIGO	FAMILIA	SUBFAMILIA	PRODUCTO	CC	PVP 2017
CORNISAS YESIFORMA					ML
14104018	1000	1021	CORNISA CR-1 (CR-204) - 1,50 M		6,52
14104015	1000	1021	CORNISA CR-2 (CR-201) - 1,50 M		7,43
14104016	1000	1021	CORNISA CR-3 (CR-202) - 1,51 M		8,45
14104027	1000	1021	CORNISA CR-4 (CR-207) - 1,46 M		10,47
14104017	1000	1021	CORNISA CR-5 (CR-203) - 1,51 M		8,46
14104506	1000	1021	CORNISA CR-6 - 1,45 M		15,80
14104507	1000	1021	CORNISA CR-7 - 1,52 M		8,45
14104019	1000	1021	CORNISA CR-8 (CR-205) - 1,52 M		10,31
14104010	1000	1021	CORNISA CR-31 (CR-GR) - 1,30 M		16,26
14104020	1000	1021	CORNISA CR-25 (CR-206) - 1,52 M		10,47
14104512	1000	1021	CORNISA CR-A 1 - 1,45 M		19,29
14104513	1000	1021	CORNISA CR-A 2 - 1,45 M		12,93
14104514	1000	1021	CORNISA CR-A 3 - 1,52 M		11,48
14104007	1000	1021	CORNISA CR-201 (CR-P) - 1,51 M		12,21
14114017	1000	1021	CORNISA CR-202 - 1,51 M		13,75
14114018	1000	1021	CORNISA CR-203 - 1,51 M		13,08
14114019	1000	1021	CORNISA CR-204 - 1,30		21,32
14114525	1000	1021	CORNISA CR-205 (CR-C) - 1,50 M		17,45
14104001	1000	1021	CORNISA CR-22 I (CR-A) - 1,52 M		9,01
14104002	1000	1021	CORNISA CR-20 I (CR-B) - 1,51 M		9,01
14104025	1000	1021	CORNISA CR-25 I (CR-F) - 1,50 M		9,01
14104003	1000	1021	CORNISA CR-23 I (CR-G) - 1,50 M		9,01
14104004	1000	1021	CORNISA CR-21 I (CR-H) - 1,52 M		9,01
14104005	1000	1021	CORNISA CR-26 I (CR-E) - 1,52 M		9,01
14104008	1000	1021	CORNISA CR-24 I (CR-L) - 1,50 M		6,52
14114027	1000	1021	CORNISA CR-27 I - 1,50 M		9,01
14104006	1000	1021	CORNISA CR-28 I (CR-O) - 1,50 M		9,01
14114039	1000	1021	CORNISA CR - 29-I - 1,50 M		9,01
14114040	1000	1021	CORNISA CR - 30-I - 1,50 M		9,01
14114041	1000	1021	CORNISA CR - 31-I - 1,50 M		9,01
14104532	1000	1021	CORNISA CR - 32-I - 1,50 M		9,01
14104533	1000	1021	CORNISA CR - 33-I TRENZA - 1,50 M		9,94
14104534	1000	1021	CORNISA CR - 34-I HOJAS - 1,50 M		9,94
14104535	1000	1021	CORNISA CR - 35-I PICOS - 1,50 M		9,94
14104536	1000	1021	CORNISA CR - 36-I ESTRELLAS - 1,50 M		9,94
14104537	1000	1021	CORNISA CR - 37-I ROMBOS - 1,50 M		9,94
14114038	1000	1021	CORNISA CR - 110 - 1,50 M		9,01
14104511	1000	1021	CORNISA CR-111 - 1,50 M		10,02

TARIFA PREFABRICADOS PVP 2.017

CODIGO	FAMILIA	SUBFAMILIA	PRODUCTO	CC	PVP 2017
--------	---------	------------	----------	----	----------

Cornisas

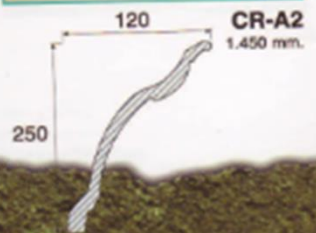
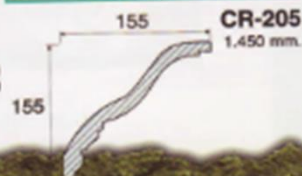
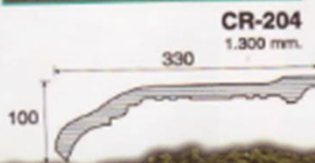
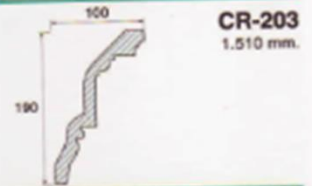
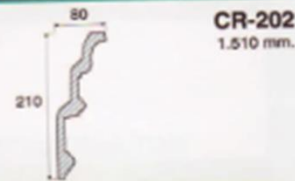
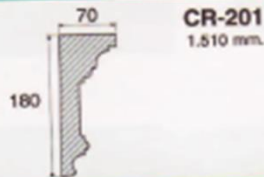
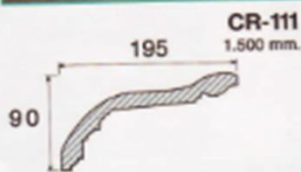
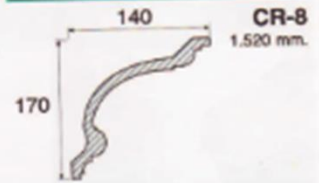
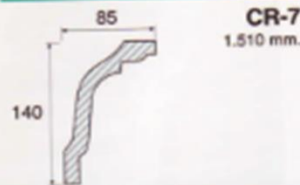
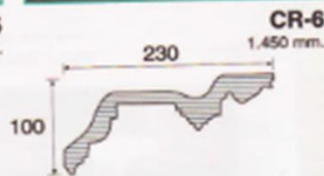
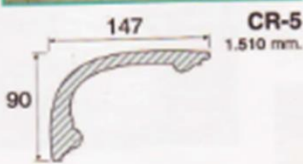
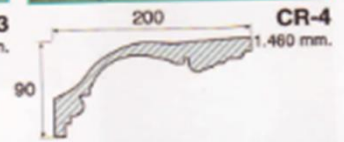
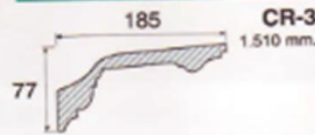
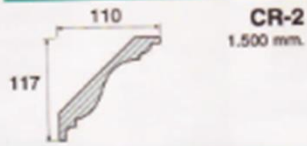
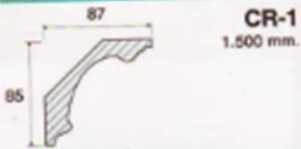

TARIFA PREFABRICADOS PVP 2.017

CODIGO	FAMILIA	SUBFAMILIA A	PRODUCTO	CC	PVP 2017
--------	---------	-----------------	----------	----	----------

Cornisas

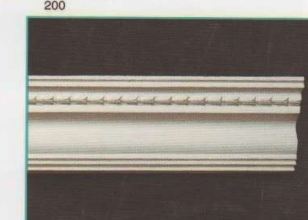
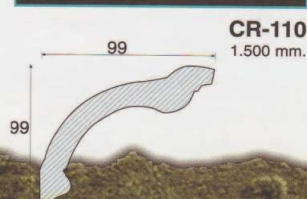
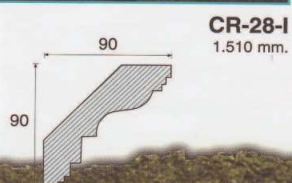
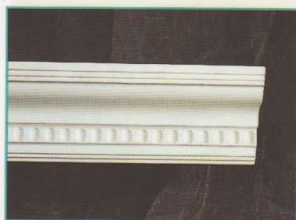
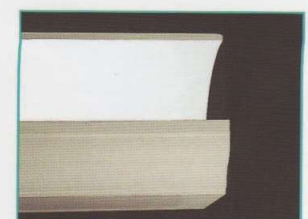
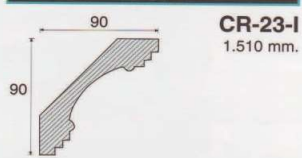
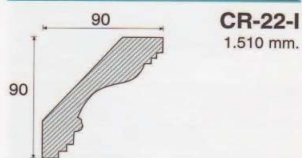
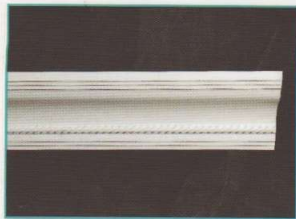
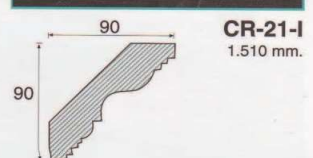
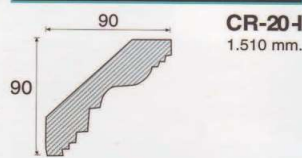
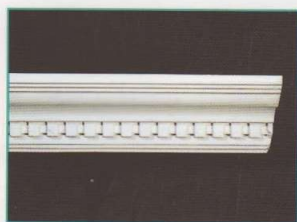
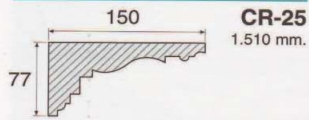
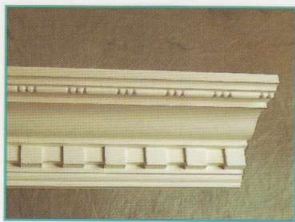
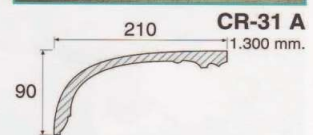
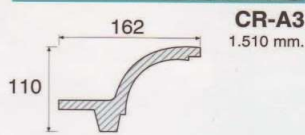
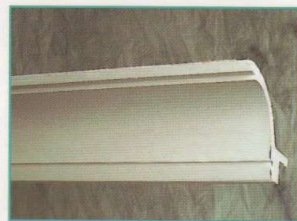
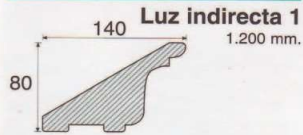

TARIFA PREFABRICADOS PVP 2.017

CODIGO	FAMILIA	SUBFAMILIA	PRODUCTO	CC	PVP 2017
--------	---------	------------	----------	----	----------

Cornisas

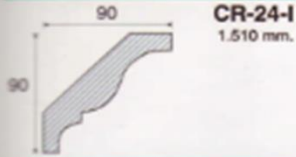

CR-24-I
1.510 mm.

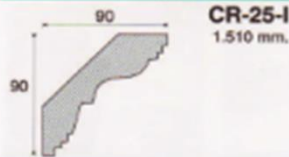

CR-25-I
1.510 mm.

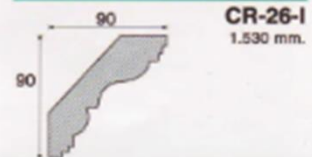

CR-26-I
1.530 mm.

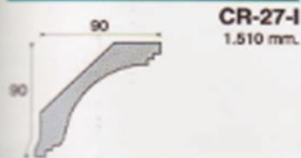

CR-27-I
1.510 mm.

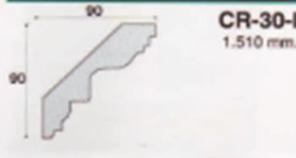

CR-30-I
1.510 mm.

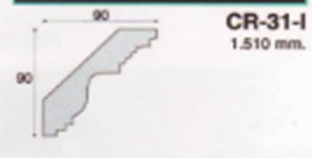

CR-31-I
1.510 mm.

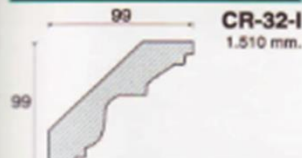

CR-32-I
1.510 mm.

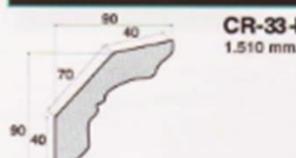

CR-33-I
1.510 mm.

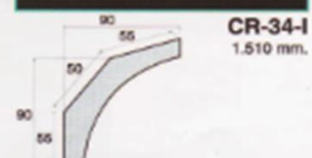

CR-34-I
1.510 mm.

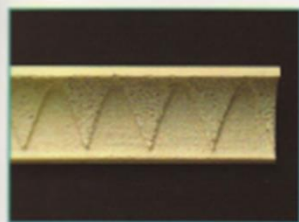

CR-35-I
1.510 mm.

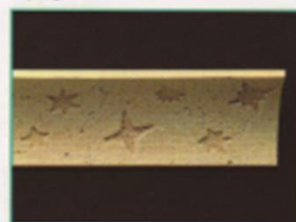

CR-36-I
1.510 mm.

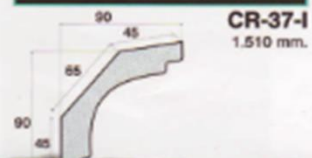

CR-37-I
1.510 mm.

TARIFA PREFABRICADOS PVP 2.017

CODIGO	FAMILIA	SUBFAMILIA	PRODUCTO	CC	PVP 2017
CORNISAS VARIAS					ML
14104101	1000	1021	CORNISA CR-M - 1,58 M		14,82
14104102	1000	1021	CORNISA CR-MP - 1,50 M		14,06
14104103	1000	1021	CORNISA CR-N - 1,50 M		12,35
14104104	1000	1021	CORNISA CR-R - 1,48 M		13,49
14104105	1000	1021	CORNISA CR-RE - 1,60 M		13,49
14104106	1000	1021	CORNISA CR-PG - 1,50 M		12,54
140703031	1000	1021	CORNISA CR. E4X4 - 4 ESCALÓN 4X4 - 1,50 M		12,16
14114021	1000	1021	CORNISA LUZ INDIRECTA N° 1 - 1,20 M		11,25
14114022	1000	1021	CORNISA LUZ INDIRECTA G - 1,20 M		10,69
14114033	1000	1021	ESCOCIA LUZ IND. (1/2 CAÑA L.I.) - 1,20 M		10,69

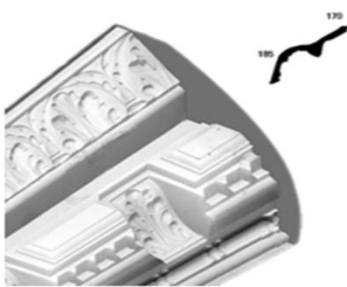

CR.M
185 x 170 x 1580mm



CR.MP
95 x 95 x 1500mm

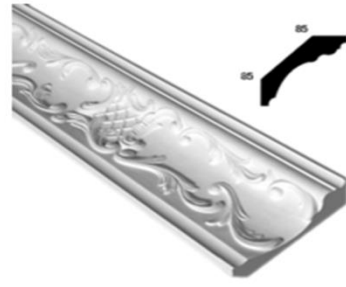

CR.N
85 x 85 x 1500mm

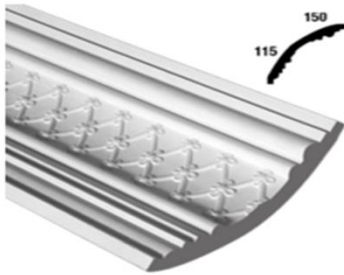

CR.R
115 x 150 x 1480mm

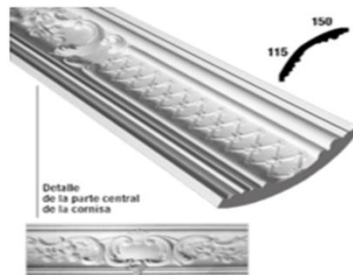

CR.RE
115 x 150 x 1600mm

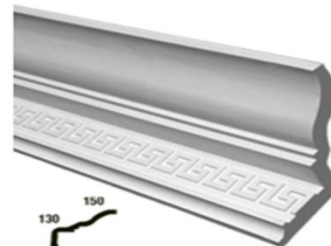

CR.PG
130 x 150 x 1500mm

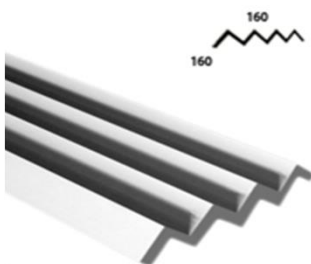

CR.4 x 4
160 x 160 x 1500mm



TARIFA PREFABRICADOS PVP 2.017

CODIGO	FAMILIA	SUBFAMILIA	PRODUCTO	CC	PVP 2017
FRISOS YESIFORMA					ML
14205001	1000	1021	FRISO FR-34 (FR-1) - 1,25 M		9,47
14205002	1000	1021	FRISO FR-6 (FR-2) - 1,50 M		5,09
14205003	1000	1021	FRISO FR-33 (FR-3) - 1,52 M		13,30
14205004	1000	1021	FRISO FR-37 (FR-4) - 1,58 M		11,12
14205005	1000	1021	FRISO FR-38 (FR-5) - 1,59 M		10,26
14205036	1000	1021	FRISO FR-35 - 1,14 M		9,47
14205039	1000	1021	FRISO FR-36 - 1,5 M		12,64
14205039	1000	1021	FRISO FR-39 - 1,50 M		15,67
14205040	1000	1021	FRISO FR-40 - 1,50 M		9,47

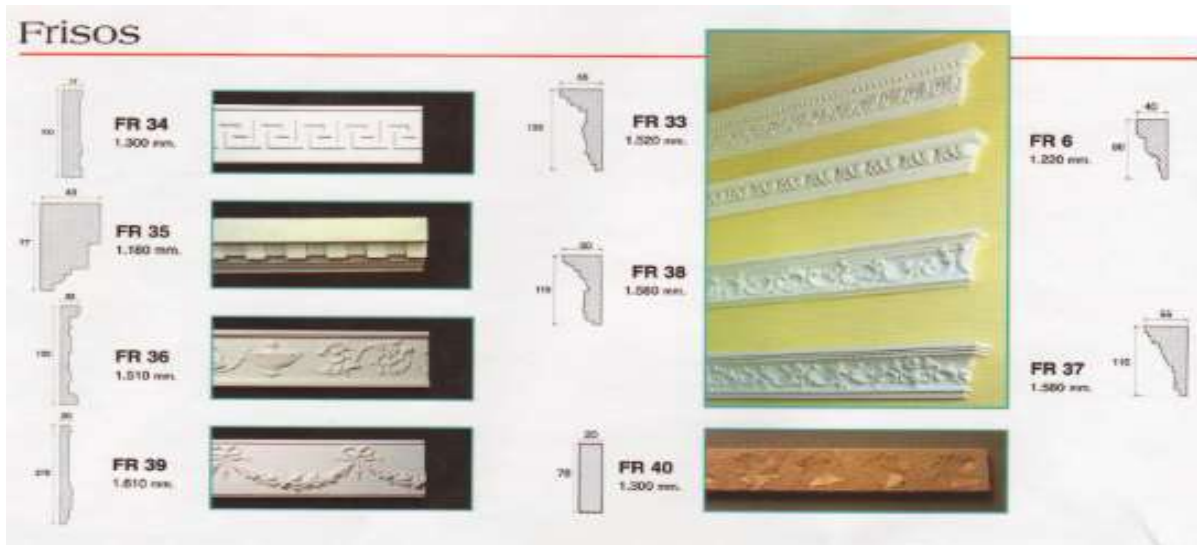

FRISOS EL ALTERÓN

CODIGO	FAMILIA	SUBFAMILIA	PRODUCTO	CC	PVP 2017
FRISOS EL ALTERÓN					ML
14280159	1000	1021	FRISO Nº 1 - 1,12 M		17,64
14280160	1000	1021	FRISO Nº 2 - 1,12 M		17,70
14280161	1000	1021	FRISO Nº 3 - 1,13 M		17,70
14280168	1000	1021	FRISO Nº 8 - 1,20 M		17,70
14280169	1000	1021	FRISO Nº 9 - 1,20 M		17,70
14280210	1000	1021	FRISO Nº 10 - 1,20 M		17,70

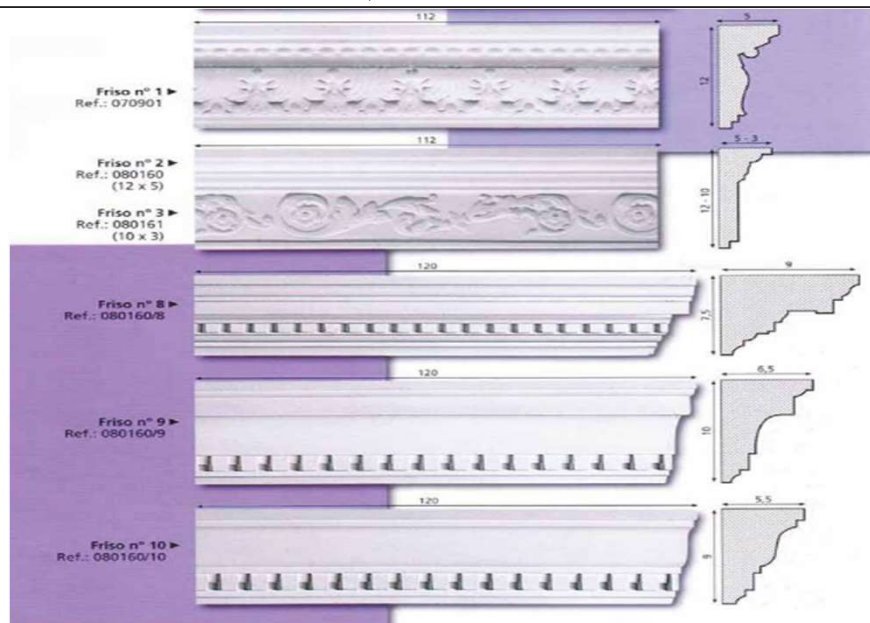

TARIFA PREFABRICADOS PVP 2.017

CODIGO	FAMILIA	SUBFAMILIA	PRODUCTO	CC	PVP 2017
PIEZAS ESPECIALES EL ALTERÓN					ML
14070303	1000	1021	ESCALÓN MÚLTIPLE 5X5X5X5 - 1,20 M		26,92
14070304	1000	1021	ANGULO CONCAVO ESCALÓN MÚLTIPLE		44,93
14070305	1000	1021	ANGULO CONVEXO ESCALÓN MÚLTIPLE		44,93
14070450	1000	1021	BANDEJA LUZ INDIRECTA (CR C.V.) - 1,5 M		21,31
14070452	1000	1021	MEDIA CAÑA LUZ INDIRECTA - 1,20 M		21,31
14080101	1000	1021	ANGULO CONCAVO MEDIA CAÑA LUZ IND.		47,58
14080102	1000	1021	ANGULO CONVEXO MEDIA CAÑA LUZ IND.		47,58
14080103	1000	1021	ANGULO CONCAVO BANDEJA LUZ IND.		47,58
14080104	1000	1021	ANGULO CONVEXO BANDEJA LUZ IND.		47,58

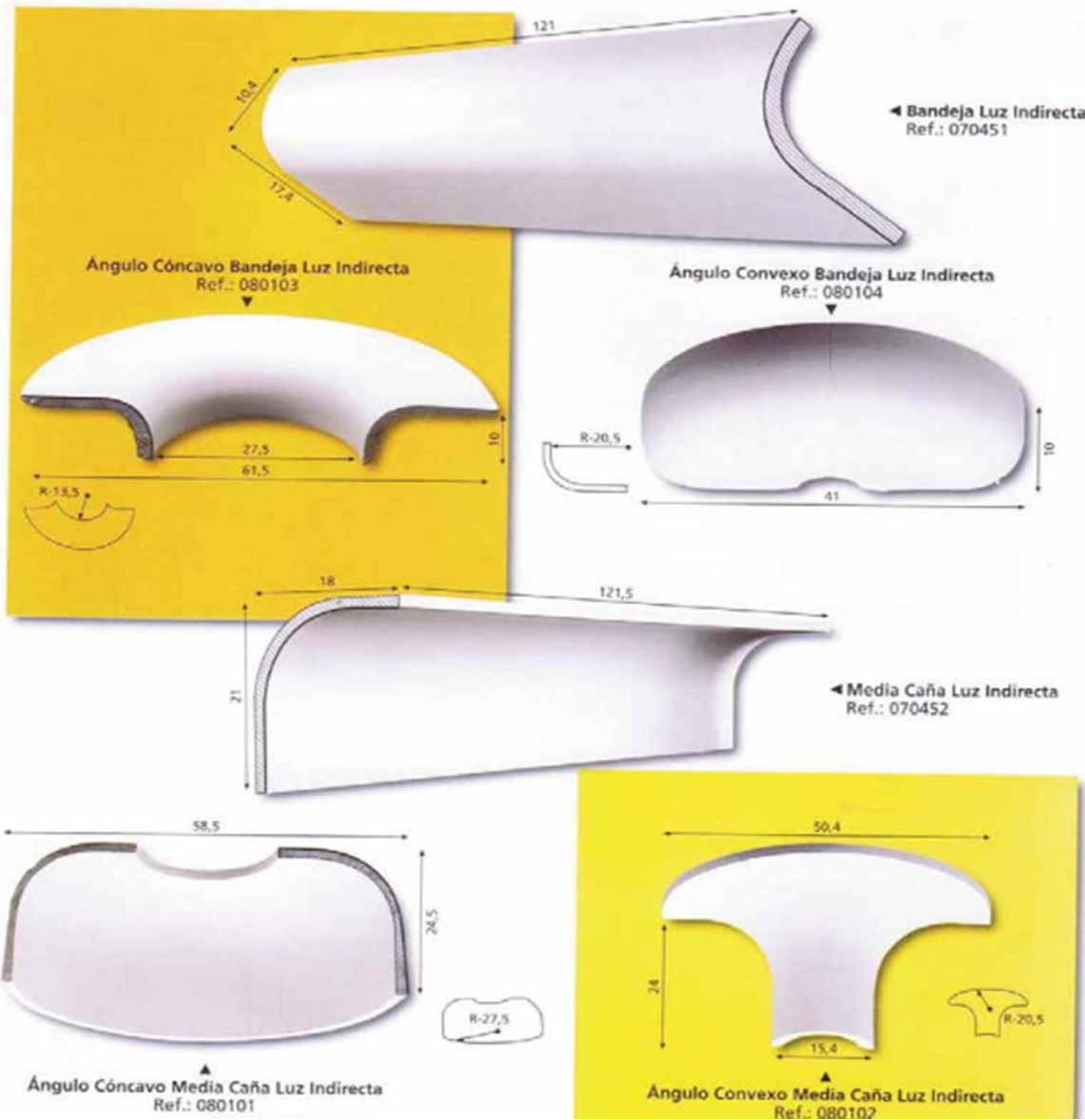

TARIFA PREFABRICADOS PVP 2.017

CODIGO	FAMILIA	SUBFAMILIA	PRODUCTO	CC	PVP 2017
ESCOCIAS EL ALTERON					ML
14020401	1000	1021	ESCOCIA LISA Nº 1 - 9 X 9 - 1.50 M		10,51
14020402	1000	1021	ESCOCIA LISA Nº 2 - 14 X 7 - 1.50 M		9,69
14020403	1000	1021	ESCOCIA LISA Nº 3 - 9,5 X 11,5 - 1 M		6,18
14020404	1000	1021	ESCOCIA LISA Nº 4 - 13,5 X 12,5 - 1 M		6,18
14020405	1000	1021	ESCOCIA LISA Nº 5 - 17 X 13 - 1.27 M		13,84
14020406	1000	1021	ESCOCIA LISA Nº 6 - 15 X 13 - 1.27 M		6,18
14020409	1000	1021	ESCOCIA LISA Nº 9 - 15 X 13,5 - 1.20 M		6,18



TARIFA PREFABRICADOS PVP 2.017

CODIGO	FAMILIA	SUBFAMILIA	PRODUCTO	CC	PVP 2017
14070406	1000	1021	ESCOCIA DECORADA Nº 6 - 1,27 M		9,50
14070407	1000	1021	ESCOCIA Nº 7 - 1,15 M		22,72
14070408	1000	1021	ESCOCIA Nº 8 - 1,26 M		25,19
14070410	1000	1021	ESCOCIA Nº 10 - 1,23 M		30,36
14070411	1000	1021	ESCOCIA Nº 11 - 1,19 M		26,66

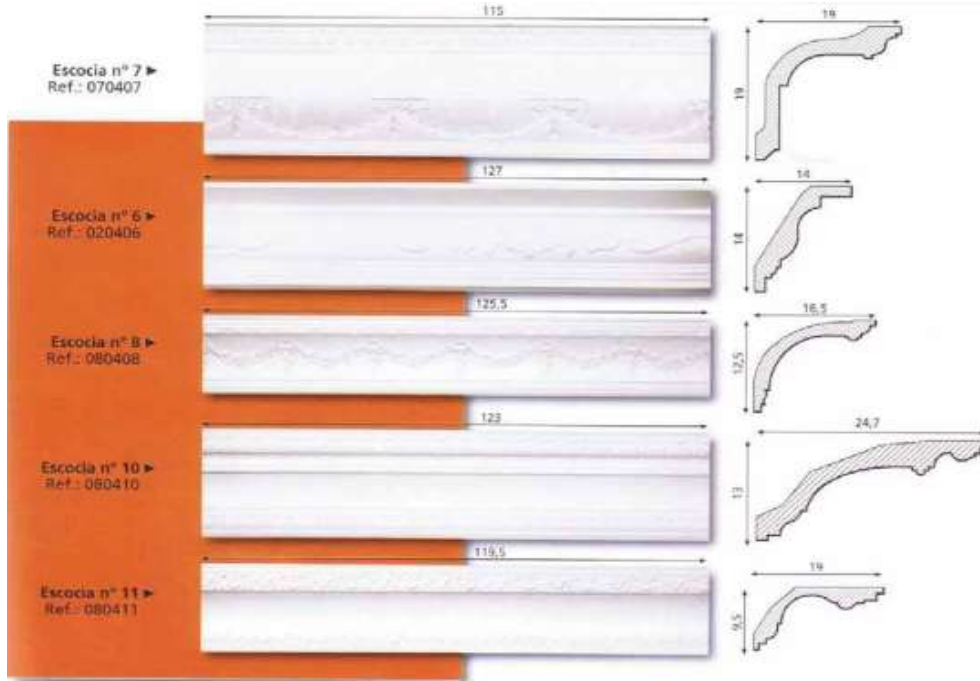

14070412	1000	1021	ESCOCIA Nº 12 - 1,26 M		30,18
14070413	1000	1021	ESCOCIA Nº 13 - 1,25 M		30,36
14070414	1000	1021	ESCOCIA Nº 14 - 1,20 M		21,09
14070415	1000	1021	ESCOCIA Nº 15 - 1,25 M		24,73
14070416	1000	1021	ESCOCIA Nº 16 - 1,05 M		20,46



TARIFA PREFABRICADOS PVP 2.017

CODIGO	FAMILIA	SUBFAMILIA	PRODUCTO	CC	PVP 2017
14070417	1000	1021	ESCOCIA Nº 17 - 1,20 M		24,68
14070418	1000	1021	ESCOCIA DECORADA Nº 18 - 1,50 M		24,68
14070419	1000	1021	ESCOCIA Nº 19 - 1,15 M		7,70
14070420	1000	1021	ESCOCIA Nº 20 - 1,21 M		26,27

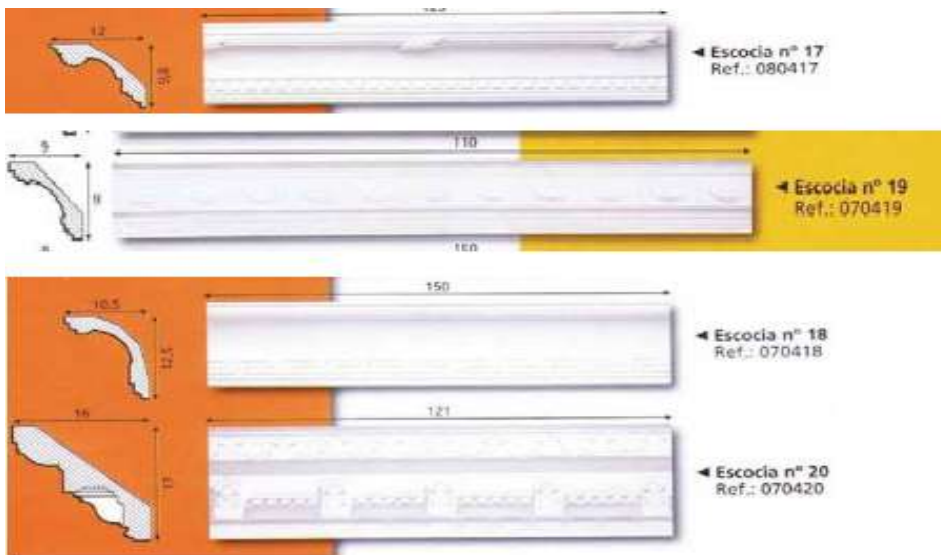

14070421	1000	1021	ESCOCIA Nº 21 - 1,10 M		17,40
14070422	1000	1021	ESCOCIA Nº 22 - 1,08 M		17,40
14070423	1000	1021	ESCOCIA Nº 23 - 1,10 M		17,40

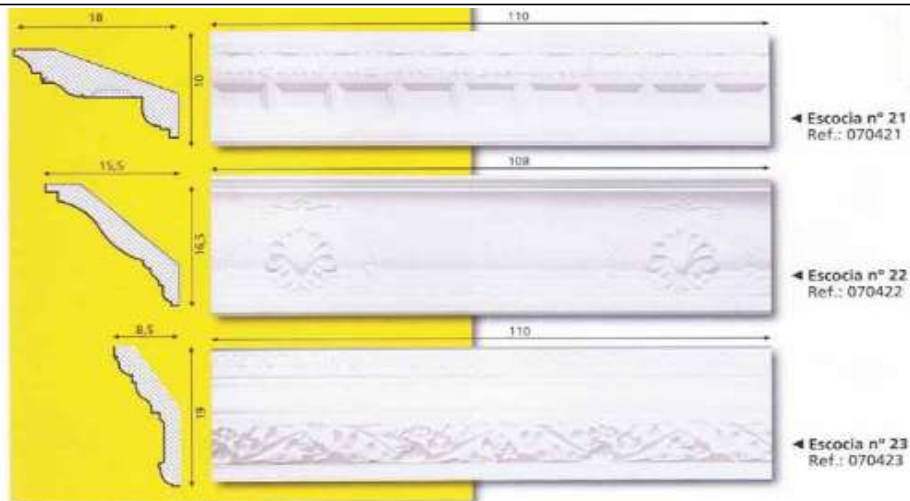

14070424	1000	1021	ESCOCIA Nº 24 - 1,17 M		7,70
14070425	1000	1021	ESCOCIA Nº 25 - 1,17 M		7,70



TARIFA PREFABRICADOS PVP 2.017

CODIGO	FAMILIA	SUBFAMILIA	PRODUCTO	CC	PVP 2017
14070426	1000	1021	ESCOCIA LISA Nº 26 - 10 X 12 - 1.26 M		20,33
14070427	1000	1021	ESCOCIA Nº 27 - 1,25 M		19,21
14070428	1000	1021	ESCOCIA Nº 28 - 1,25 M		19,21
14070429	1000	1021	ESCOCIA Nº 29 - 1,21 M		7,70
14070430	1000	1021	ESCOCIA Nº 30 - 1,09 M		26,27

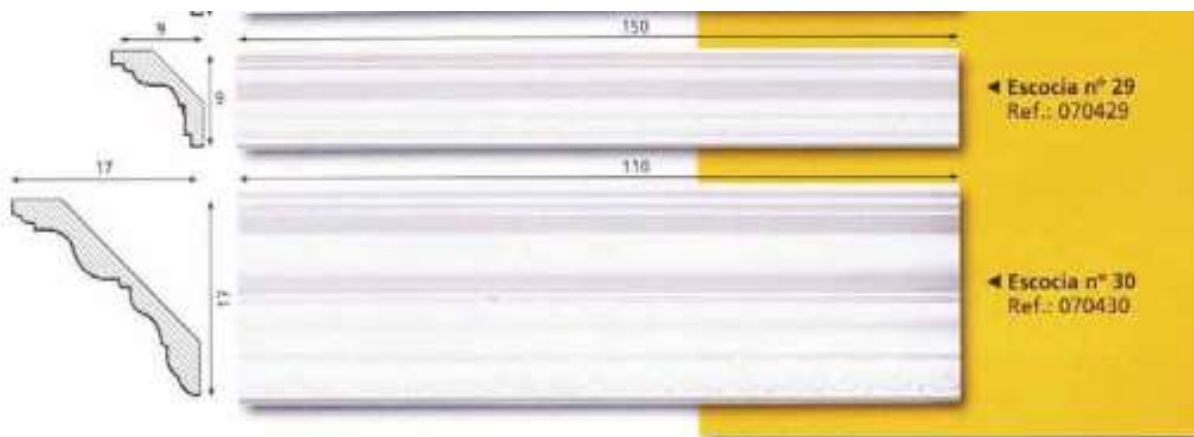

14020502	1000	1021	LUZ INDIRECTA Nº 2 - 1,20 M		8,44
----------	------	------	-----------------------------	--	------



TARIFA PREFABRICADOS PVP 2.017

CODIGO	FAMILIA	SUBFAMILIA	PRODUCTO	CC	PVP 2017
		A			

BAQUETONES

ML

14512001	1000	1022	BAQUETON BL-01 - 1,25 M		3,51
14512002	1000	1022	BAQUETON BQT-OO (BL-00) - 1,25 M		3,51
14512003	1000	1022	BAQUETON BL-03 - 1,25 M		3,51
14512004	1000	1022	BAQUETON BL-04 - 1,25 M		3,51
14512005	1000	1022	BAQUETON BL-05 - 1,25 M		3,60

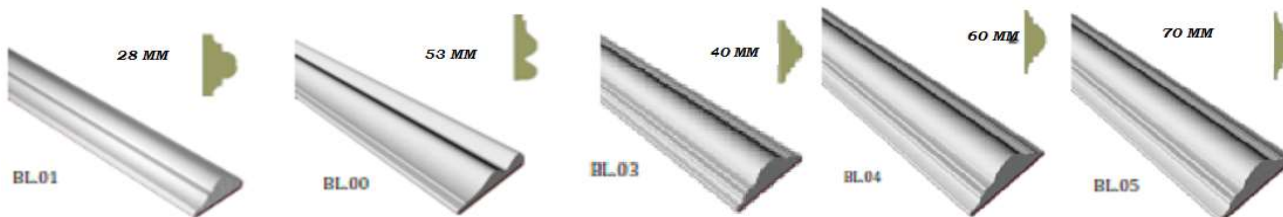

14512006	1000	1022	BAQUETON BQT-6-B (BL-6)		3,51
14512007	1000	1022	BAQUETON BQT-65-BE (BL-7) - 1,25 M		3,51
14512008	1000	1022	BAQUETON BL-08 - 1,25 M		3,51
14512009	1000	1022	BAQUETON BL-09 (GORDO) - 1,25 M		3,51
14512010	1000	1022	BAQUETON BQT-64-BE (BL-10) - 1,25 M		3,60

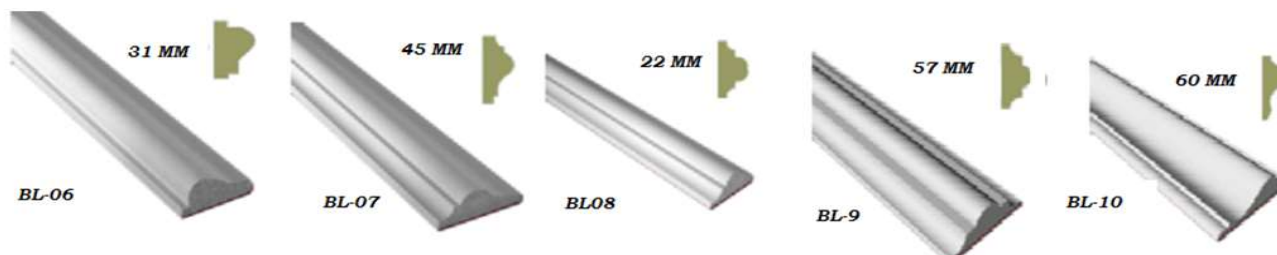

14512012	1000	1022	BAQUETON BQT-255 (BD-255) - 1,20 M		3,51
14512013	1000	1022	BAQUETON BD-01 - 1,57 M		3,59
14512014	1000	1022	BAQUETON BQT-C 1 (BD-02) - 1,19 M		3,51
14512015	1000	1022	BAQUETON BQT-63 B (BD-04) - 1,19 M		3,82



14512016	1000	1022	BAQUETON BD-06 - 1,55 M		3,82
14512101	1000	1022	BAQUETON BD-01 F - 1,25 M		3,51
14512052	1000	1022	BAQUETON BQT-52 B (BD-07) - 1,20 M		3,51
14520231	1000	1035	BAQUETON BQT-231 (BD-05) - 1,15 M		3,51
14520254	1000	1022	BAQUETON BD.254 (CORDÓN) - 1.25 M		3,51

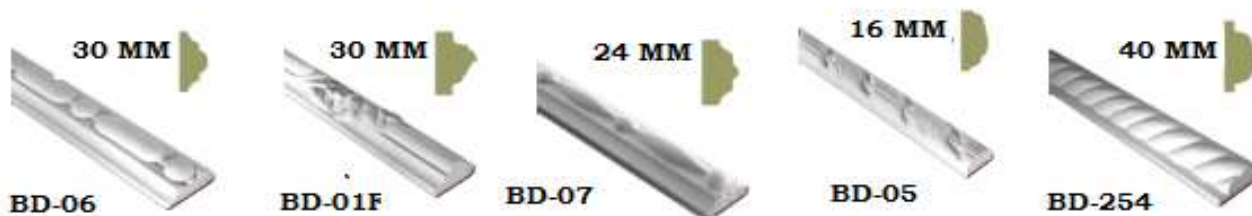

TARIFA PREFABRICADOS PVP 2.017

CODIGO	FAMILIA	SUBFAMILIA	PRODUCTO	CC	PVP 2017
14512003	1000	1022	BAQUETON BQT-3S-A - 1,20 M		3,43
14512004	1000	1022	BAQUETON BQT-4S-A - 1,20 M		3,89
14512005	1000	1022	BAQUETON BQT-5S-A - 1,20 M		3,89
14520101	1000	1022	BAQUETON BQT-O1-A - 1 M		3,42
14520105	1000	1022	BAQUETON BQT-6S-A - 1,20 M		3,89
14520106	1000	1022	BAQUETON BQT-06		3,89
14520066	1000	1022	BAQUETON BQT-66-BE - 1,25 M		4,44
14520067	1000	1022	BAQUETON BQT-67-BE - 1,25 M		4,44
14520068	1000	1022	BAQUETON BQT-68-BE - 1,25 M		4,44
14520107	1000	1022	BAQUETON BQT-7-T - 4 CM - 1,20 M		3,89
14520108	1000	1022	BAQUETON BQT-7 T - 5 CM - 1,20 M		3,89
14020253	1000	1022	BAQUETON BQT-253-B - 1,11 M		3,89
14520384	1000	1022	BAQUETON BQT-384 - 1,20 M		3,89

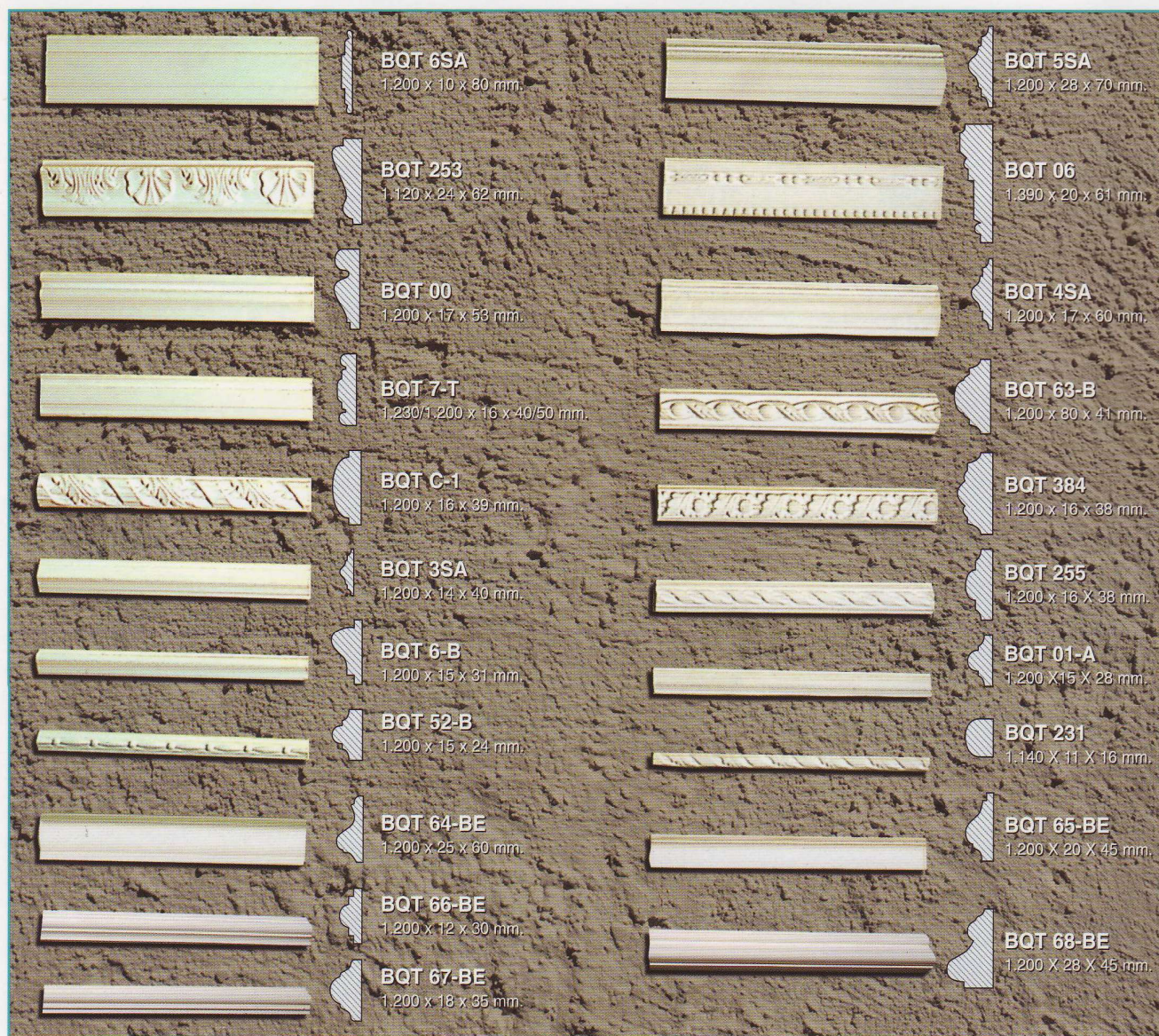

TARIFA PREFABRICADOS PVP 2.017

CODIGO	FAMILIA	SUBFAMILIA	PRODUCTO	CC	PVP 2017
ANGULARES					UD
14614001	1000	1022	ANGULAR A-01		5,28
14614002	1000	1022	ANGULAR E-01		5,28
14614007	1000	1022	ANGULAR A-08		5,28
14614008	1000	1022	ANGULAR E-08		5,28
					
14614012	1000	1022	ANGULAR ED-01		5,28
14614006	1000	1022	ANGULAR AD-06		5,28
14614016	1000	1022	ANGULAR ED-06		5,28
					
14605001	1000	1022	ANGULAR AGL-01		7,03
14605003	1000	1022	ANGULAR AGL-02 (E-B-00)		5,47
14605004	1000	1022	ANGULAR AGL-03		5,71
14605002	1000	1022	ANGULAR AGL-01-AB		5,71
14605008	1000	1022	ANGULAR AGL-C1-A (A-BD-02)		5,71
14605009	1000	1022	ANGULAR AGL-C1-AB (E-BD-02)		5,71
14605035	1000	1022	ANGULAR AGL-3 SA		6,38
14605045	1000	1022	ANGULAR AGL-4 SA		7,13
14605055	1000	1022	ANGULAR AGL-5 SA		7,81
14605063	1000	1022	ANGULAR AGL-H-63 AB (E-BD-04)		7,37
14605074/75/76	1000	1022	ANGULAR AGL-7-TL / 7-TT / 7-TX - 4 CM		4,34
14605077/78/79	1000	1022	ANGULAR AGL-7-TL / 7-TT / 7-TX - 5 CM		4,34
14605255	1000	1022	ANGULAR AGL-255-A (A-BD-255)		6,28
14605256	1000	1022	ANGULAR AGL-H-255-AB		7,02
14605521	1000	1022	ANGULAR AGL-H-521		7,02
14605530	1000	1022	ANGULAR AGL-H-530		7,02
14605005	1000	1022	ANGULAR AGL-06-A		6,22
14605006	1000	1022	ANGULAR AGL-6-AB		6,22

TARIFA PREFABRICADOS PVP 2.017

CODIGO	FAMILIA	SUBFAMILIA	PRODUCTO	CC	PVP 2017
14605013	1000	1022	ANGULAR AGL-52 A (A-BD-07)		5,28
14605014	1000	1022	ANGULAR AGL-52 AB (E-BD-07)		5,28
14605015	1000	1022	ANGULAR AGL-231-A (A-BD-05)		5,28
14605016	1000	1022	ANGULAR AGL-231-AB (E-BD-05)		5,28
14605030	1000	1022	ANGULAR AGL-64-BEC		7,02
14605031	1000	1022	ANGULAR AGL-64-BEG		7,68
14605032	1000	1022	ANGULAR AGL-64-BEP		7,30
14605033	1000	1022	ANGULAR AGL-64-BE-1		7,30
14605034	1000	1022	ANGULAR AGL-64-BE-2		8,81
14605040	1000	1022	ANGULAR AGL - 40		7,64
14605067	1000	1022	ANGULAR AGL - 66-BE		7,30
14605068	1000	1022	ANGULAR AGL - 67-BE		7,30

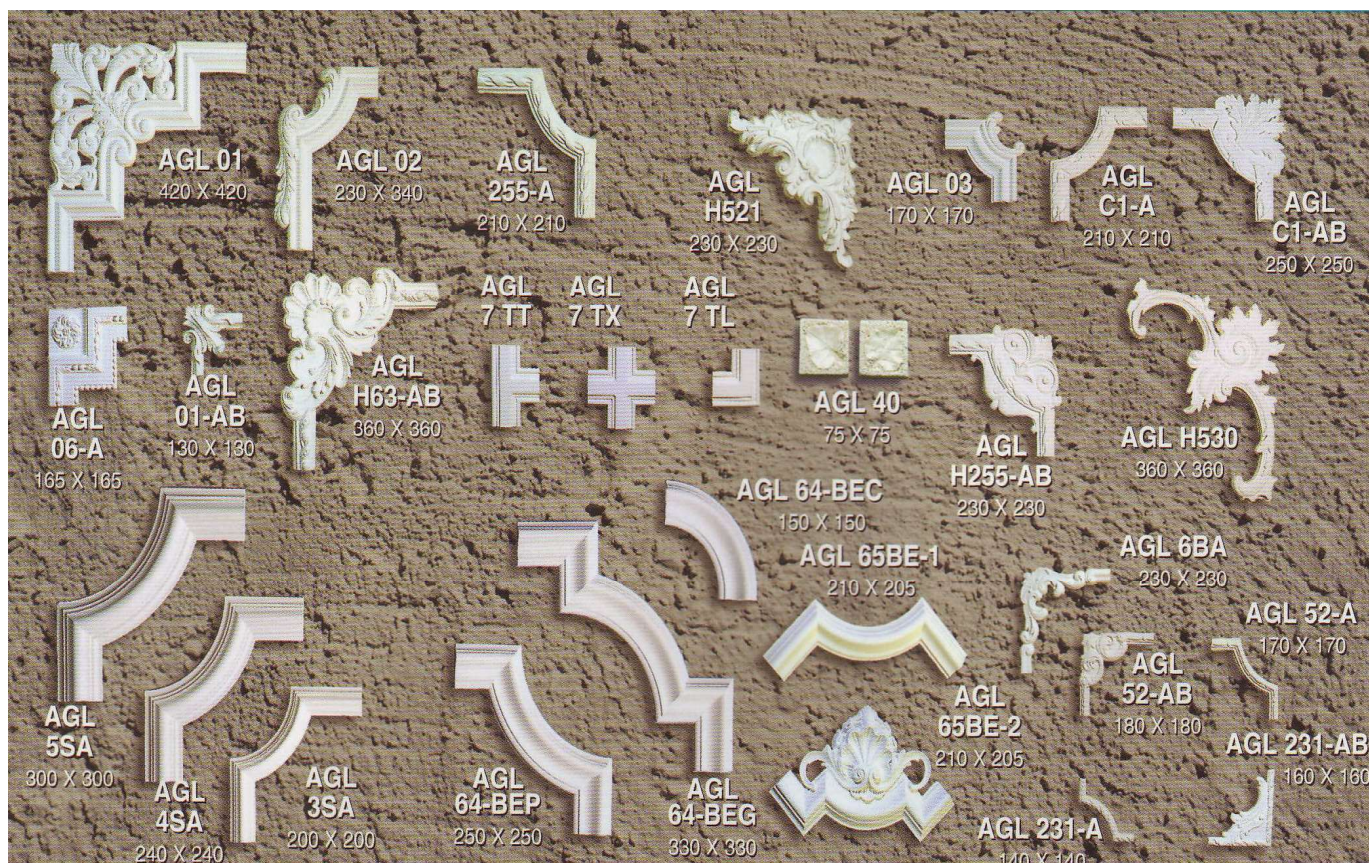

TARIFA PREFABRICADOS PVP 2.017

CODIGO	FAMILIA	SUBFAMILIA	PRODUCTO	CC	PVP 2017
MOLDURAS DE TECHO DE EL ALTERON					ML
14520200	1000	1022	MOLDURA TECHO Nº 0 - 1.20 M		4,99
14520151	1000	1022	MOLDURA TECHO Nº 1 - 1.05 M		3,96
14520152	1000	1022	MOLDURA TECHO Nº 2 - 1.05 M		3,96
14580150/3	1000	1022	MOLDURA TECHO Nº 3 - 1.00 M		5,40
14580150/4	1000	1022	MOLDURA TECHO Nº 4 - 1.00 M		5,40
14570205	1000	1022	MOLDURA TECHO Nº 5 - 1.15 M		4,99
14570206	1000	1022	MOLDURA TECHO Nº 6 - 1.15 M		4,99
14570207	1000	1022	MOLDURA TECHO Nº 7 - 1.20 M		4,99
14570208	1000	1022	MOLDURA TECHO Nº 8 - 1.20 M		5,10
14570209	1000	1022	MOLDURA TECHO Nº 9 - 1.03 M		5,10
14570210	1000	1022	MOLDURA TECHO Nº 10 - 1.20 M		5,10
14580150/11	1000	1022	MOLDURA TECHO Nº 11 - 1.20 M		5,10
1458150/12	1000	1022	MOLDURA TECHO Nº 12 - 1.20 M		5,10
14580150/13	1000	1022	MOLDURA TECHO Nº 13 - 1.20 M		5,10
14580150/14	1000	1022	MOLDURA TECHO Nº 14 - 1 M		5,10
14580150/15	1000	1022	MOLDURA TECHO Nº 15 - 1 M		5,10
14580150/16	1000	1022	MOLDURA TECHO Nº 16 - 1.25 M		5,10
14570817	1000	1022	MOLDURA TECHO Nº 17 - 1.05 M		5,10
ESCUADRAS Y AROS DE EL ALTERÓN					UD
14670601	1000	1022	ESCUADRA Nº 1 - M. TECHO Nº 2		14,15
14670602	1000	1022	ESCUADRA Nº 2 - M. TECHO Nº 3		14,15
14670603	1000	1022	ESCUADRA Nº 3 - M. TECHO Nº 3		14,15
14670604	1000	1022	ESCUADRA Nº 4 - M. TECHO Nº 1		14,15
14670605	1000	1022	ESCUADRA Nº 5 - M. TECHO Nº 1		14,15
1468070606	1000	1022	ESCUADRA Nº 6 - M. TECHO Nº 3		14,15
1468070607	1000	1022	ESCUADRA Nº 7 - M. TECHO Nº 4		14,15
1468070608	1000	1022	ESCUADRA Nº 8 - M. TECHO Nº 3		14,15
1460870609	1000	1022	ESCUADRA Nº 9 - M. TECHO Nº 3		14,15
1468070610	1000	1022	ESCUADRA Nº 10 - M. TECHO Nº 4		14,15
14670611	1000	1022	ESCUADRA Nº 11 - M. TECHO Nº 7		12,11
14670612	1000	1022	ESCUADRA Nº 12 - M. TECHO Nº 6		12,11
14670613	1000	1022	ESCUADRA Nº 13 - M. TECHO Nº 6		11,89
14670614	1000	1022	ESCUADRA Nº 14 - M. TECHO Nº 9		12,11
14670615	1000	1022	ESCUADRA Nº 15 - M. TECHO Nº 14		14,15
14670616	1000	1022	ESCUADRA Nº 16 - M. TECHO Nº 14		14,15
14670651/30	1000	1022	ARO TECHO Nº 1 - 30 CM.		14,38
14670651/51	1000	1022	ARO TECHO Nº 1 - 51 CM.		18,99
1468070651/25	1000	1022	ARO TECHO Nº 1 - 25 CM.		14,38
1468070651/36	1000	1022	ARO TECHO Nº 1 - 36 CM.		14,38
1468070652/35	1000	1022	ARO TECHO Nº 2 - 35 CM.		14,38
1468070652/51	1000	1022	ARO TECHO Nº 2 - 51 CM.		19,04
1468070653/23	1000	1022	ARO TECHO Nº 3 - 23 CM.		14,38
1468070653/31	1000	1022	ARO TECHO Nº 3 - 31 CM.		14,38
1468070653/40	1000	1022	ARO TECHO Nº 3 - 40 CM.		14,92

TARIFA PREFABRICADOS PVP 2.017

CODIGO	FAMILIA	SUBFAMILIA	PRODUCTO	CC	PVP 2017
--------	---------	------------	----------	----	----------

Molduras Techo-Pared y Complementos

Moldura Techo nº 0
Ref.: 070200

Q 51 cm.

Q 36,5 cm.

Q 30 cm.

Q 25,5 cm.

Ref.:08070651/25
Ref.:070651/30
Ref.:08070651/36
Ref.:070651/51

Aro Techo nº 1

Q 52,5 cm.

Q 35 cm.

Ref.:08070652/35
Ref.:08070652/51

Aro Techo nº 2

Q 40,5 cm.

Q 31,7 cm.

Q 22,5 cm.

Ref.:08070653/23
Ref.:08070653/31
Ref.:08070653/40

Aro Techo nº 3

Escuadra nº 4 ▼
Ref.: 070604

Escuadra nº 5
Ref.: 070605

Moldura Techo nº 1 ▲
Ref.: 020151

Escuadra nº 3
Ref.: 070603

Escuadra nº 2 izquierda y derecha
Ref.: 070602

Moldura Techo nº 2
Ref.: 020152

Moldura Techo nº 3
Ref.: 080150/3

Escuadra nº 9
Ref.: 08070609

Escuadra nº 6 ▼
Ref.: 08070606

Escuadra nº 8
Ref.: 08070608

TARIFA PREFABRICADOS PVP 2.017

CODIGO	FAMILIA	SUBFAMILIA	PRODUCTO	CC	PVP 2017
CUPULAS					UD
1608081	1000	1060	CÚPULA CON ARO 45 CM		113,98
1608082	1000	1060	CÚPULA CON ARO 65 CM		121,60
1608083	1000	1060	CÚPULA CON ARO 100 CM		209,00
1608084	1000	1060	CÚPULA CON LUZ INDIRECTA 120 CM		284,99
1608085	1000	1060	CÚPULA ESTRIADA 60X60		98,79

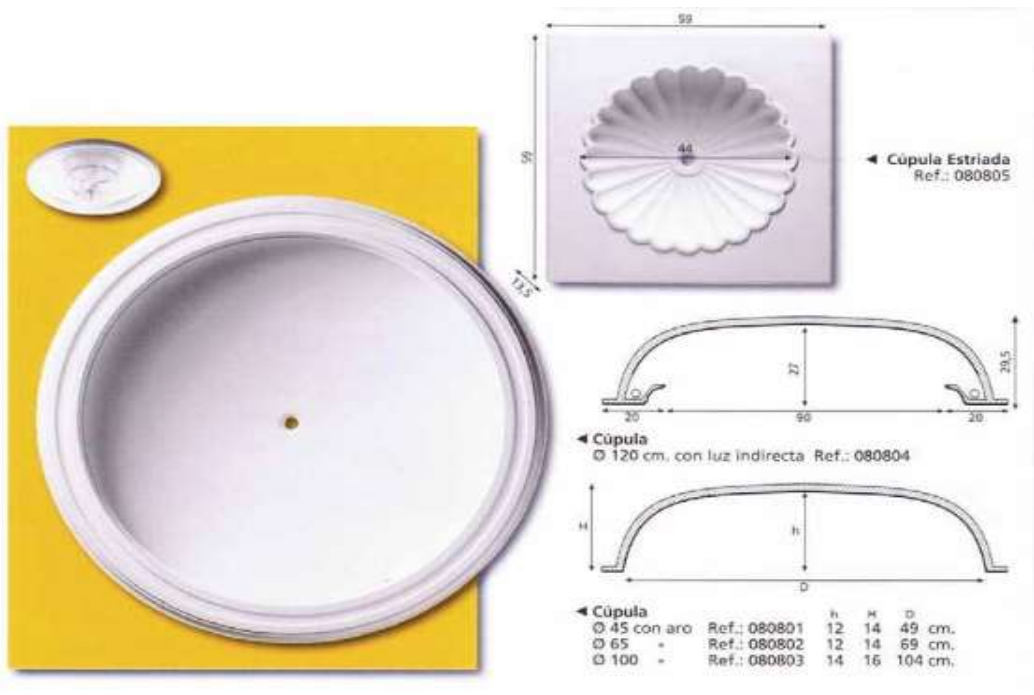

16176041	1000	1024	CÚPULA ESTRIADA 60X60		38,18
----------	------	------	-----------------------	--	-------



AROS

					UD
17026101	1000	1024	ARO PEQUEÑO 31 CM DIAMETRO		8,12
17026102	1000	1024	ARO MEDIANO 41 CM DIAMETRO		8,98
17026103	1000	1024	ARO GRANDE 51 CM DIAMETRO		9,62
17026104	1000	1024	ARO GRANDE 61 CM DIAMETRO		10,69



TARIFA PREFABRICADOS PVP 2.017

CODIGO	FAMILIA	SUBFAMILIA	PRODUCTO	CC	PVP 2017
FLORONES YESIFORMA					UD
17026001	1000	1024	PLAFÓN PR-59 (FL-1)		10,58
17026002	1000	1024	PLAFÓN PR-54 (FL-2)		10,58
17026003	1000	1024	PLAFÓN PR-52 (FL-3)		10,58
17026004	1000	1024	PLAFÓN PR-53 (FL-4)		10,58
17026005	1000	1024	PLAFÓN PR-51 (FL-5)		10,58



FL1-280mm



FL2-290mm



FL3-330mm



FL4-330mm



FL5-340mm

17026006	1000	1024	PLAFÓN PR-140 (FL-6)		10,58
17026007	1000	1024	PLAFÓN YF-10 (FL-7)		22,93
17026008	1000	1024	PLAFÓN YF-11 (FL-8)		22,93
17026064	1000	1024	PLAFÓN YF-14 (FL-9)		22,93
17026010	1000	1024	PLAFÓN PF-3 (FL-10)		22,93



FL6-360mm



FL8-390mm



FL9-390mm



FL10-400mm

17026011	1000	1024	PLAFÓN YF-8 (FL-11)		22,93
17026013	1000	1024	PLAFÓN YF-13 (FL-13)		22,93
17026014	1000	1024	PLAFÓN PF-4 (FL-14)		22,93
17026015	1000	1024	PLAFÓN YF-6 (FL-15)		22,93



FL11-400mm



FL13-410mm



FL14-440mm



FL15-440mm

TARIFA PREFABRICADOS PVP 2.017

CODIGO	FAMILIA	SUBFAMILIA	PRODUCTO	CC	PVP 2017
17026016	1000	1024	PLAFÓN PF-5 (FL-16)		22,93
17026017	1000	1024	PLAFÓN PR-88 (FL-17)		24,95
17026018	1000	1024	PLAFÓN PF-7 (FL-18)		22,93
17026019	1000	1024	PLAFÓN PF-6 (FL-19)		22,93



FL16-470mm



FL17-490mm



FL18-500mm



FL19-530mm

17026020	1000	1024	PLAFÓN YF-20 I (FL-20)		22,93
17026021	1000	1024	PLAFÓN YF-21 I (FL-21)		22,93
17026022	1000	1024	PLAFÓN YF-22 I (FL-22)		22,93
17026023	1000	1024	PLAFÓN YF-23 I (FL-23)		22,93



FL20-540mm



FL21-540mm



FL22-540mm



FL23-540mm

17026025	1000	1024	PLAFÓN PF-9 (FL-25)		22,93
17026026	1000	1024	PLAFÓN PR-156 (FL-26)		24,93
17026027	1000	1024	PLAFÓN PF-8 (FL-27)		22,93
17026031	1000	1024	PLAFÓN PF-1 (FL-31)		23,40



FL25-620mm



FL26-640mm



FL27-660mm



FL31-490x680

TARIFA PREFABRICADOS PVP 2.017

CODIGO	FAMILIA	SUBFAMILIA	PRODUCTO	CC	PVP 2017
17026032	1000	1024	PLAFÓN PF-2 (FL-32)		22,93
17026033	1000	1024	PLAFÓN PR-100 (FL-33)		34,63
17026034	1000	1024	PLAFÓN PR-104 (FL-34)		14,45
17026035	1000	1024	PLAFÓN PR-181 (FL-35)		34,63



FL32-350x480



FL33-630x780



FL34-310x430



FL35-675x880

17026060	1000	1024	PLAFÓN PF-10		22,93
17026061	1000	1024	PLAFÓN PF-11		22,93



PF-10 Ø 500mm.

PF-11 Ø 610 mm.

17026062	1000	1024	PLAFÓN PF-12		58,73
17026063	1000	1024	PLAFÓN PF-13 (FL-30)		58,73
17026064	1000	1024	PLAFÓN PF-14		58,73



PF-12 Ø 890 mm.

PF-13 Ø 960 mm.

PF-14 Ø 860 mm.

TARIFA PREFABRICADOS PVP 2.017

CODIGO	FAMILIA	SUBFAMILIA	PRODUCTO	CC	PVP 2017
17026065	1000	1024	PLAFÓN PF-15 (FL-29)		58,73
17026066	1000	1024	PLAFÓN PF-16		58,73
17026068	1000	1024	PLAFÓN PR-88 AB (FL-28)		34,63

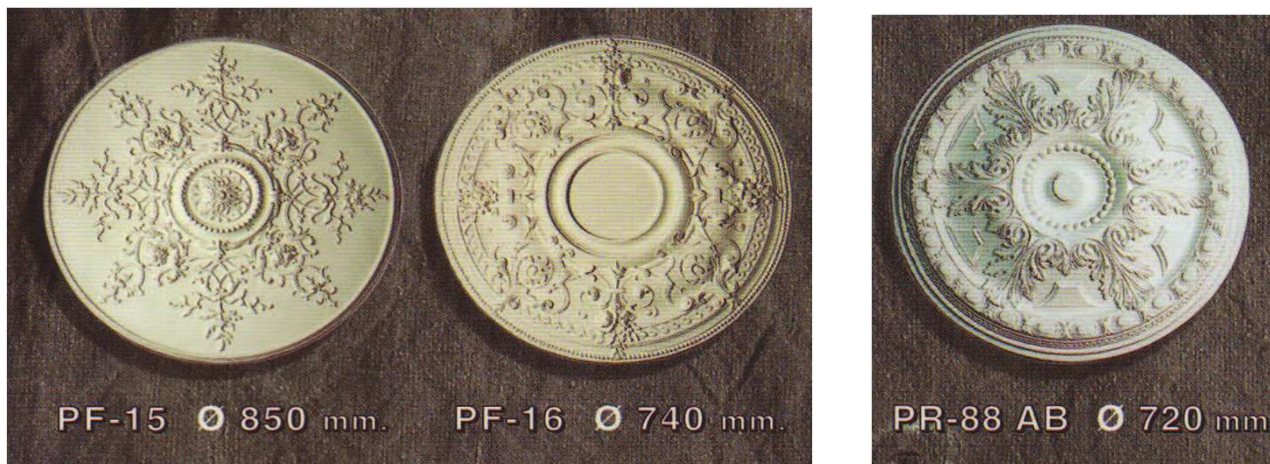

17026071	1000	1024	PLAFÓN YF-1		47,00
17026082	1000	1024	PLAFÓN YF-12		22,93
17026089	1000	1024	PLAFÓN PR-207		34,63



1000	1024	PLAFÓN LISO P-1	8,91
1000	1024	PLAFÓN LISO P-2 - 35 CM	6,52
1000	1024	PLAFÓN LISO P-3 - 32 CM	6,52
1000	1024	PLAFÓN LISO P-4 - 26 CM	6,52
1000	1024	PLAFÓN LISO 60 CM	9,99



TARIFA PREFABRICADOS PVP 2.017

CODIGO	FAMILIA	SUBFAMILIA	PRODUCTO	CC	PVP 2017
17027401/2/3/4	1000	1024	FLOR Nº 1, 2, 3 Y 4 - ARNAIZ		3,10
17027405/6/7/8	1000	1024	FLOR Nº 5, 6, 7 Y 8 - ARNAIZ		3,10
17027409/10	1000	1024	FLOR Nº 9 Y 10 - ARNAIZ		2,50
17027411/12	1000	1024	FLOR Nº 11 Y 12 - ARNAIZ		2,50
17027413/14	1000	1024	FLOR Nº 13 Y 14 - ARNAIZ		2,50

FLORES Y ROSETONES PEQUEÑOS

UD



17081701	1000	1024	ROSETÓN Nº 1 - 11,5 CM		9,24
17081702	1000	1024	ROSETÓN Nº 2 - 13 X 7,5 CM		9,24
17081703	1000	1024	ROSETÓN Nº 3 - 4,5 CM		9,24
17081704	1000	1024	ROSETÓN Nº 4 - 4,5 CM		9,24



TARIFA PREFABRICADOS PVP 2.017

CODIGO	FAMILIA	SUBFAMILIA	PRODUCTO	CC	PVP 2017
17070501	1000	1024	FLORÓN Nº 1		8,80
17070502	1000	1024	FLORÓN Nº 2		8,80
17070503	1000	1024	FLORÓN Nº 3		8,80
17070504	1000	1024	FLORÓN Nº 4		8,80

FLORONES ALTERÓN

UD



17070505	1000	1024	FLORÓN Nº 5		8,80
17070506	1000	1024	FLORÓN Nº 6		8,80
17070507	1000	1024	FLORÓN Nº 7		21,78
17070508	1000	1024	FLORÓN Nº 8		8,80



17070509	1000	1024	FLORÓN Nº 9		19,76
17070510	1000	1024	FLORÓN Nº 10		28,71
17070511	1000	1024	FLORÓN Nº 11		28,71
17070512	1000	1024	FLORÓN Nº 12		19,76



TARIFA PREFABRICADOS PVP 2.017

CODIGO	FAMILIA	SUBFAMILIA	PRODUCTO	CC	PVP 2017
17070513	1000	1024	FLORÓN Nº 13		19,76
17070515	1000	1024	FLORÓN Nº 15		19,76
17070516	1000	1024	FLORÓN Nº 16		19,76



17070517	1000	1024	FLORÓN Nº 17		72,90
17070518	1000	1024	FLORÓN Nº 18		89,63
17070519	1000	1024	FLORÓN Nº 19		17,29



17070520	1000	1024	FLORÓN Nº 20		26,66
17070521	1000	1024	FLORÓN Nº 21		26,66
17070522	1000	1024	FLORÓN Nº 22		26,66



TARIFA PREFABRICADOS PVP 2.017

CODIGO	FAMILIA	SUBFAMILIA	PRODUCTO	CC	PVP 2017
17070523	1000	1024	FLORÓN Nº 23		26,66
17070524	1000	1024	FLORÓN Nº 24		17,29
17070525	1000	1024	FLORÓN Nº 25		17,29



17070526	1000	1024	FLORÓN Nº 26		26,66
17070527	1000	1024	FLORÓN Nº 27		26,66
17070528	1000	1024	FLORÓN Nº 28		26,66



17081801	1000	1024	IMPRONTA Nº 1 - 61 CM		52,94
17081802	1000	1024	IMPRONTA Nº 2 - 69 CM		52,94



TARIFA PREFABRICADOS PVP 2.017

CODIGO	FAMILIA	SUBFAMILIA	PRODUCTO	CC	PVP 2017
--------	---------	------------	----------	----	----------

ESTANTERIAS



Librerías



◀ Librería estilo 1
Construida con estanterías de 30 y 40 x 4 x 120 cm.

UD

15050151	1000	1025	ZOCALO 50	28,07
----------	------	------	-----------	-------



15050120	1000	1025	ESTANTERIA 20 X 4	9,67
15050125	1000	1025	ESTANTERIA 25 X 4	12,36
15050130	1000	1025	ESTANTERIA 30 X 4	13,77
15050135	1000	1025	ESTANTERIA 35 X 4	15,84
15050140	1000	1025	ESTANTERIA 40 X 4	18,20
15050145	1000	1025	ESTANTERIA 45 X 4	20,37
15050150	1000	1025	ESTANTERIA 50 X 4	22,59

Estantería ▶	
Ref.: 050120	20
Ref.: 050125	25
Ref.: 050130	30
Ref.: 050135	35
Ref.: 050140	40
Ref.: 050145	45
Ref.: 050150	50

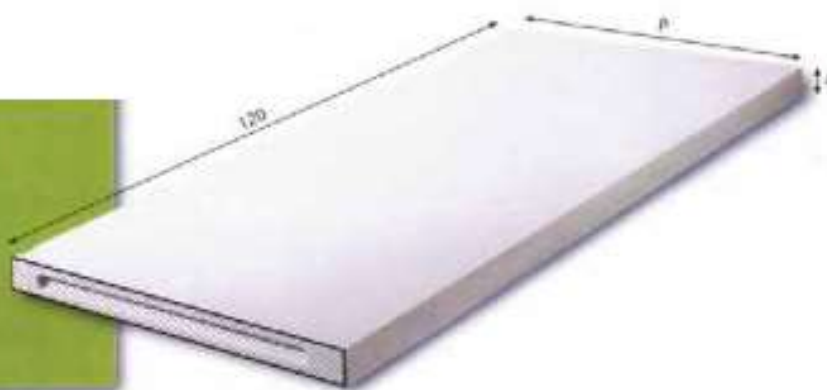

www.galuso.gal

TARIFA PREFABRICADOS PVP 2.017

CODIGO	FAMILIA	SUBFAMILIA	PRODUCTO	CC	PVP 2017
		A			
ARCOS Y COMPLEMENTOS					UD
19071003	1000	1060	ARCO Nº 3 - 20X20		7,74
19071004	1000	1060	ARCO Nº 4 - 25X25		9,83
19071006	1000	1060	ARCO Nº 6 - 35X35		11,75

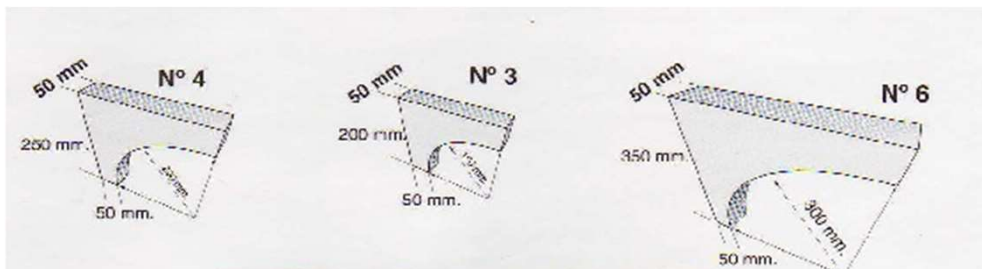

17080323	1000	1060	ARCO VITRINA 80 - 86X48		48,92
17080324	1000	1060	ARCO VITRINA 60 - 66X38		47,38



19080307	1000	1060	ARCO ESTANTERÍA MOLDURADO 100 CM		93,65
19080308	1000	1060	ARCO ESTANTERÍA MOLDURADO 80 CM		86,72



19080301	1000	1060	CAPITEL CORNISA		10,02
19080302	1000	1060	CORNISA ESTANTERÍA		15,31



TARIFA PREFABRICADOS PVP 2.017

CODIGO	FAMILIA	SUBFAMILIA A	PRODUCTO	CC	PVP 2017
19080303	1000	1060	PILAstra CAPITEL 4 X 80		14,17
19080305	1000	1060	PILAstra BASE 4 X 80		14,17
19080304	1000	1060	PILAstra CAPITEL 8 X 80		17,00
19080306	1000	1060	PILAstra BASE 8 X 80		17,00
19080309	1000	1060	PILAstra ALARGADERA 4 X 80		10,76
19080310	1000	1060	PILAstra ALARGADERA 8 X 80		12,09

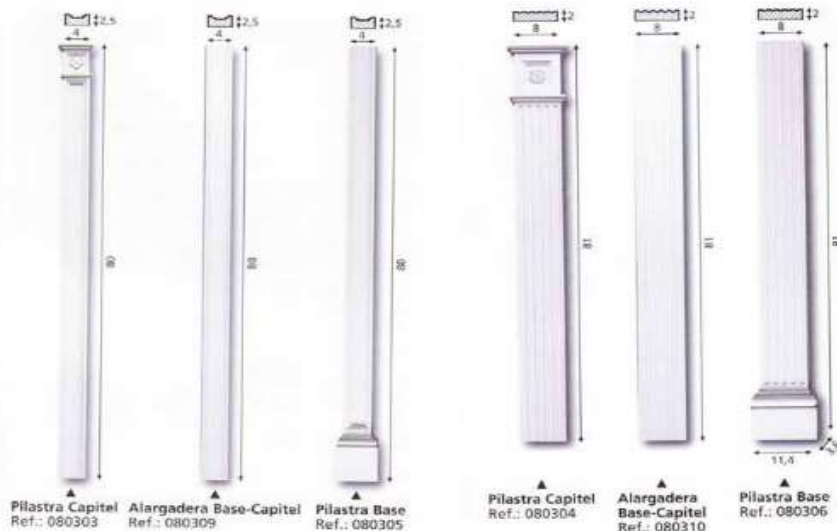

19080311	1000	1060	ARCO LIBRERÍA DECORADO Nº 1 - 116 CM		61,86
19080312	1000	1060	ARCO LIBRERÍA DECORADO Nº 2 - 96 CM		61,86
19080314	1000	1060	PILAstra ARCO DECORADO		14,93



TARIFA PREFABRICADOS PVP 2.017

CODIGO	FAMILIA	SUBFAMILIA	PRODUCTO	CC	PVP 2017
<u>CAPITELES YESIFORMA</u>					<u>UD</u>
19077001	1000	1060	CAPITEL C1-P		7,96
19077003	1000	1060	CAPITEL C2-P		7,96
19077002	1000	1060	CAPITEL C1-G		7,96
19077004	1000	1060	CAPITEL C2-G		7,96
19077010	1000	1060	CAPITEL DE REMATE C-700 A		8,53
19077011	1000	1060	CAPITEL DE REMATE C-800 A		8,53

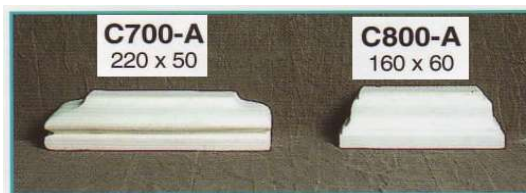
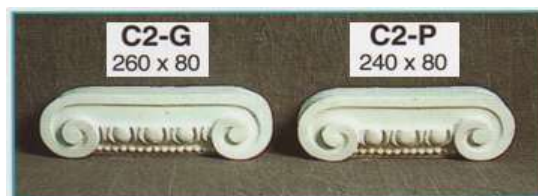

PILASTRAS YESIFORMA

UD

19072001	1000	1060	PILASTRA PL-P - ML		10,48
19072002	1000	1060	PILASTRA PL-G . ML		10,75
19072007	1000	1060	PILASTRA PL-700 A - ML		10,48
19072008	1000	1060	PILASTRA PL-800 A - ML		10,48

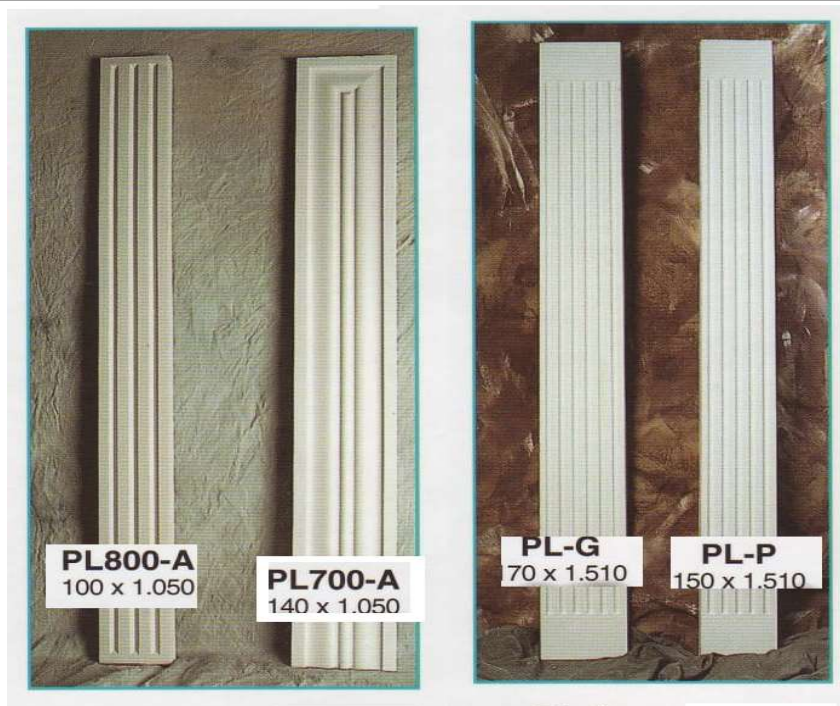

TARIFA PREFABRICADOS PVP 2.017

CODIGO	FAMILIA	SUBFAMILIA	PRODUCTO	CC	PVP 2017
MENSULAS YESIFORMA					UD
19070001	1000	1060	MENSULA ESPEJO (ME-1)		11,15
19070900	1000	1060	MENSULA MK-900 (ME-2)		9,98
19070800	1000	1060	MENSULA MK-800		7,14
19070239	1000	1060	MENSULA MK-239 (ME-6)		11,02



Ménsula Espejo
160 x 240 mm.

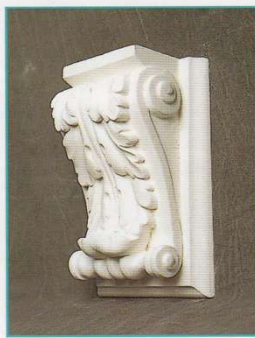

K-900
140 x 240 mm.



K-800
100 x 130 mm.

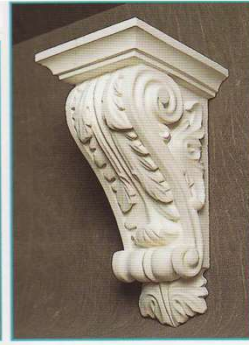

K-239
130 x 300 mm.

19070600	1000	1060	MENSULA MK-600 (ME-5)		19,47
19070043	1000	1060	MENSULA MK-43		11,15
19070044	1000	1060	MENSULA MK-44		11,15
19070100	1000	1060	MENSULA MK-1000 AB		7,93



K-600
225 x 410 mm.



K-43
140 x 210 mm.



K-44
110 x 170 mm.



K-1000 AB
95 x 140 mm.

19070700	1000	1060	MENSULA MK-700 A (ME-8)		19,52
19070801	1000	1060	MENSULA MK-800 A (ME-9)		19,52



K800-A
530 x 300 x 100 mm.



K700-A
400 x 300 x 140 mm.

TARIFA PREFABRICADOS PVP 2.017

CODIGO	FAMILIA	SUBFAMILIA	PRODUCTO	CC	PVP 2017
ARCOS ALTERON					UD
19080201	1000	1060	ARCO Nº 1 - 100 X 50 X 6,5		62,60
19080202	1000	1060	ARCO Nº 2 - 100 X 30 X 6,5		62,60
19080500	1000	1060	PILAISTRA Nº 1 - 100X6,5		6,64
19080906	1000	1060	CANET Nº 6 - 17X6,5		9,37

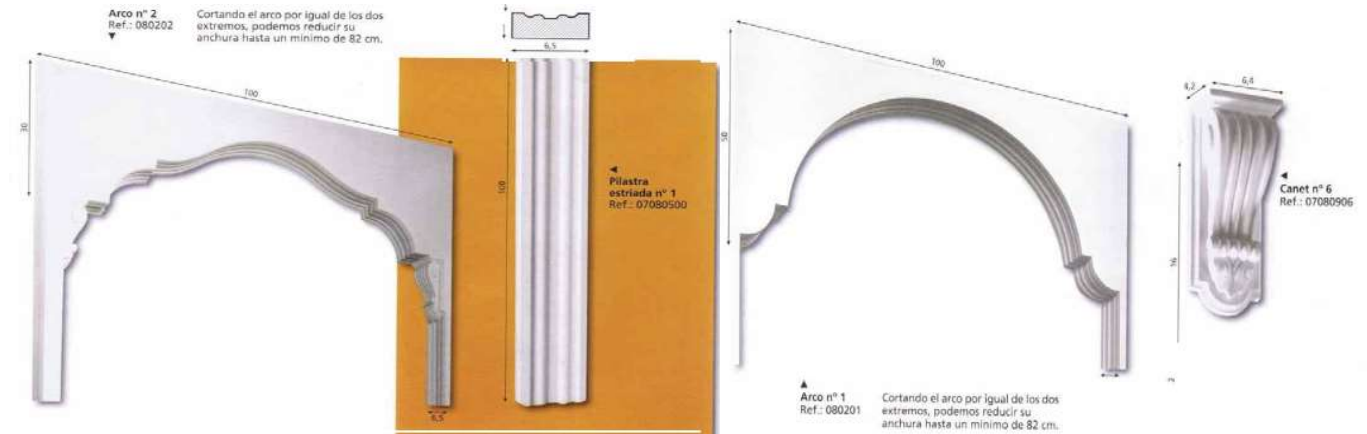

19080203	1000	1060	ARCO Nº 3 - 120 X 30 X 1 5		90,01
19080501	1000	1060	PILAISTRA CON FLOR Nº 1 - 110X15		17,44
19080502	1000	1060	PILAISTRA CON FLOR Nº 2 - 110X15		17,44
19080503	1000	1060	PILAISTRA Nº 3 - 110X15		16,91
19080506	1000	1060	PILAISTRA Nº 6 - 110X14		15,31
19080546	1000	1060	PILAISTRA BASE Nº 6 - 100X14		25,82
19080547	1000	1060	PILAISTRA CAPITEL Nº 6 - 100X14		33,67
19080607	1000	1060	PILAISTRA ALARGADERA Nº 7 - 100X15		41,41
19080507	1000	1060	PILAISTRA COLUMNA Nº 7 - 100X15		66,23
19080901	1000	1060	CANET Nº 1 - 50X24X15		19,97
19080902	1000	1060	CANET Nº 2 - 24X15		18,73

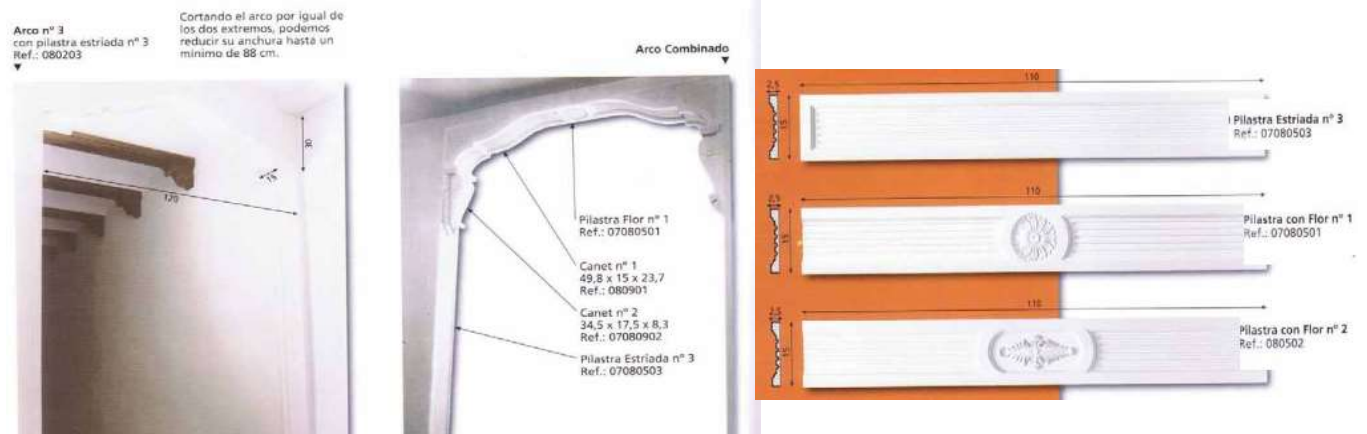

TARIFA PREFABRICADOS PVP 2.017

CODIGO	FAMILIA	SUBFAMILIA	PRODUCTO	CC	PVP 2017
19080204	1000	1060	ARCO N° 4 - 270 X 65 X 25		273,94
19080504	1000	1060	PILASTRA LISA N° 4 - 100X25		21,51
19080954	1000	1060	DOBLE CANET N° 4 - 40X25		38,91
19081054	1000	1060	BASE ARCO N° 4		16,04

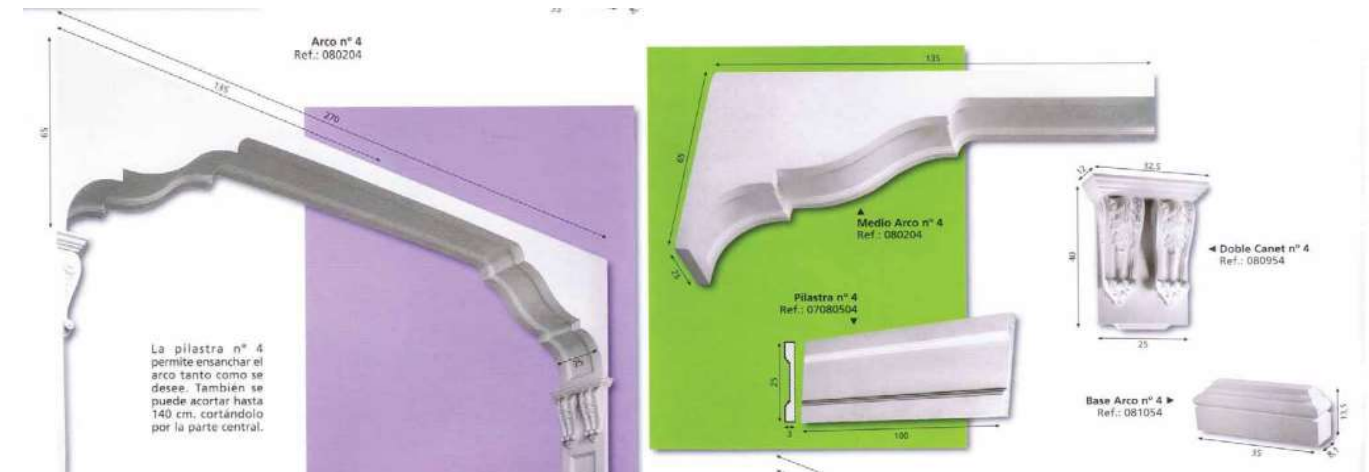

19080205	1000	1060	ARCO N° 5 - 240 X 80 X 35		450,07
19080555	1000	1060	DOBLE PILASTRA N° 5 - 100X40		56,53
19080605	1000	1060	ALARGADERA N° 5 - 100X35		41,41
19080955	1000	1060	DOBLE CANET N° 5 - 40X35		42,71
19081055	1000	1060	BASE ARCO N° 5		18,73



TARIFA PREFABRICADOS PVP 2.017

CODIGO	FAMILIA	SUBFAMILIA	PRODUCTO	CC	PVP 2017
19080206	1000	1060	ARCO Nº 6 - 220 X 70 X 35		430,48
19080207	1000	1060	ARCO Nº 7 - CON PLAFÓN		469,61
19080606	1000	1060	ALARGADERA Nº 6 - 100X35		41,41

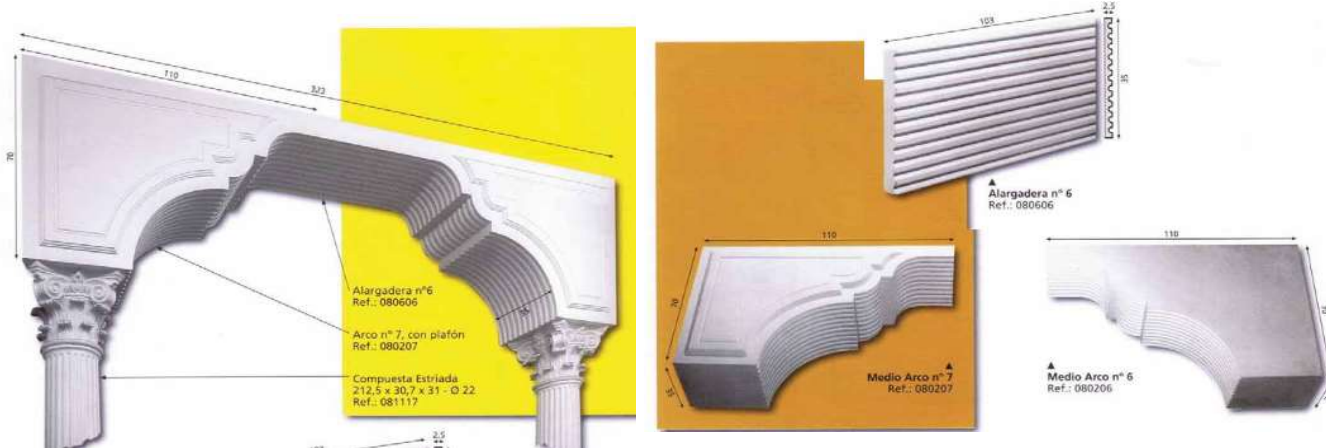

19080208	1000	1060	ARCO Nº 8 - 160 X 45 X 20		219,14
19080508	1000	1060	PILASTRA Nº 8 - 100X20		18,76
19080910	1000	1060	CANET Nº 10 - 42X17X10		18,71

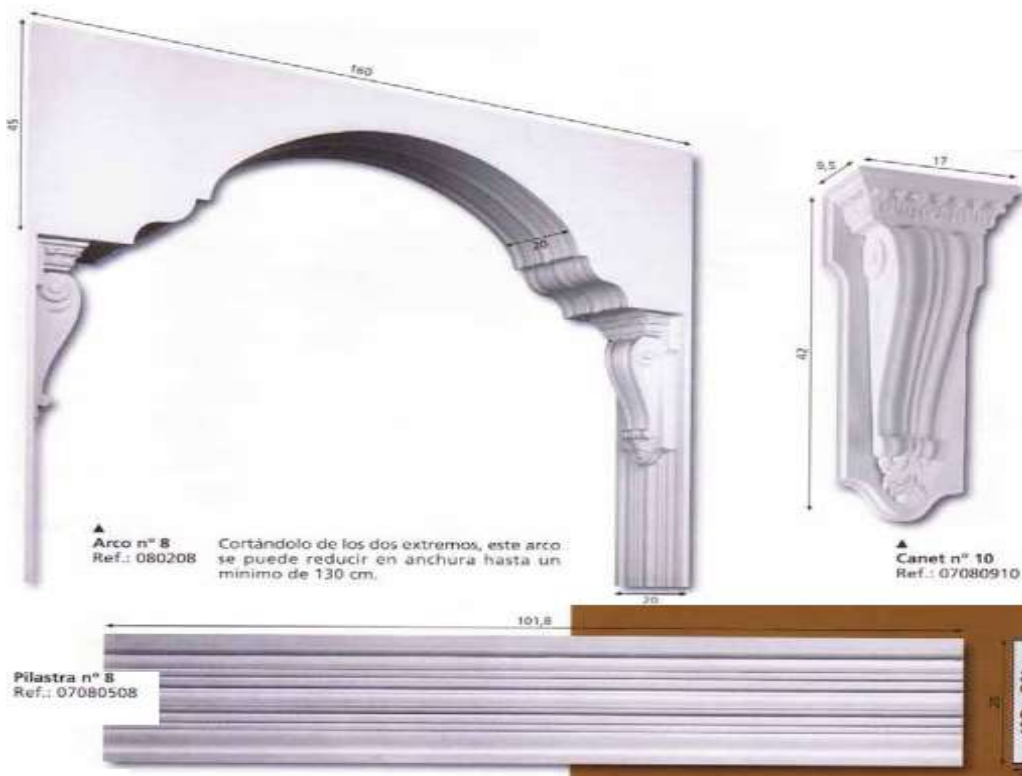

www.galuso.gal

TARIFA PREFABRICADOS PVP 2.017

CODIGO	FAMILIA	SUBFAMILIA	PRODUCTO	CC	PVP 2017
19080209	1000	1060	ARCO N° 9 - 140 X 50 X 20		219,14
19080509	1000	1060	PILAstra BASE N° 9 - 100X20		60,61
19080559	1000	1060	PILAstra CAPITEL N° 9 - 100X20		60,61
19080609	1000	1060	PILAstra ALARGADERA N° 9 - 100X20		31,45

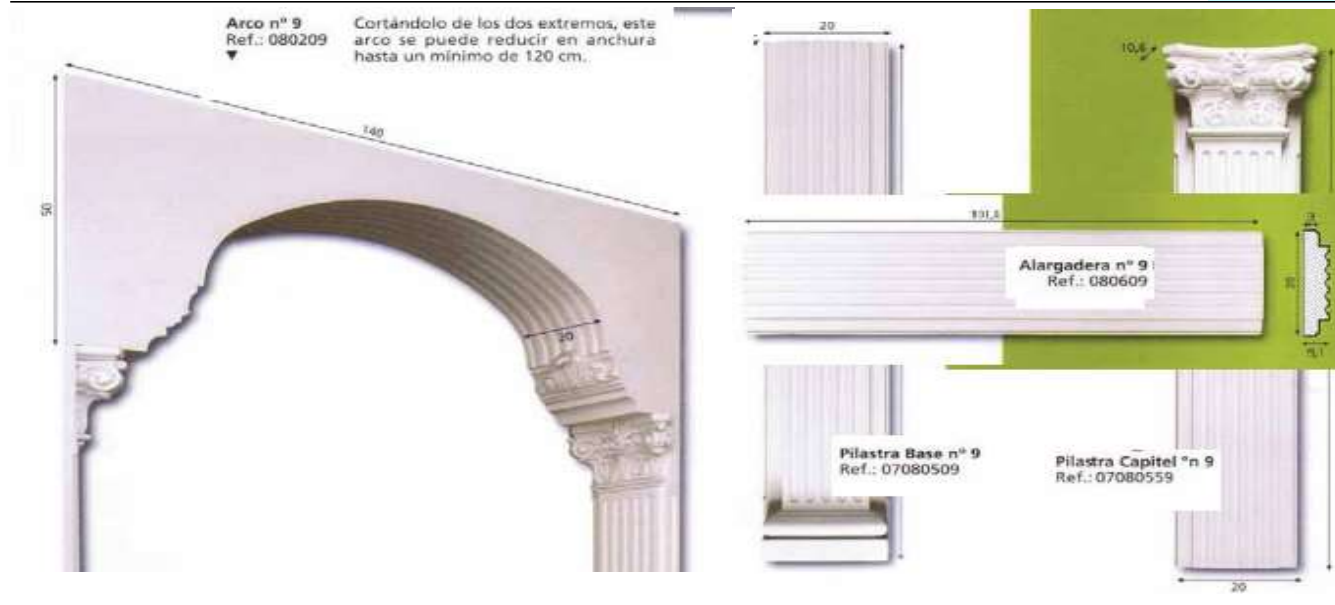

19080210	1000	1060	ARCO N° 10 - 10 X 35 X 120		93,89
19080211	1000	1060	ARCO N° 11 - 10 X 35 X 120		93,89
19080510	1000	1060	PILAstra N° 10 - 3X10X100		15,31
19080511	1000	1060	PILAstra N° 11 - 3X10X100		15,31
19080929	1000	1060	CANET N° 29 - 23 X 11 X 11		18,69
19080931	1000	1060	CANET N° 31 - 17 X 10 X 7		17,28

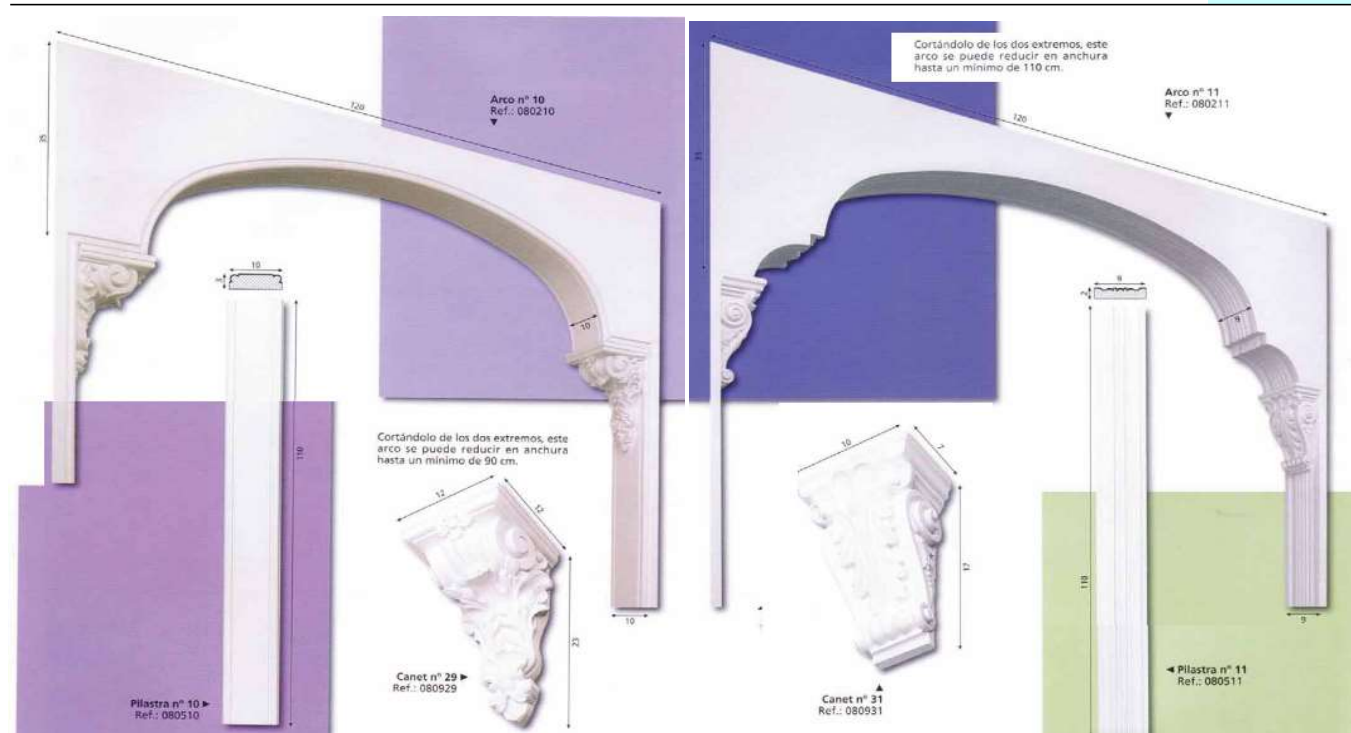

TARIFA PREFABRICADOS PVP 2.017

CODIGO	FAMILIA	SUBFAMILIA	PRODUCTO	CC	PVP 2017
19080212	1000	1060	ARCO N° 12 - 9 X 22.5 X 100 cm		78,28
19080918	1000	1060	CANET N° 18 - 4X8X8X4		9,37



19080213	1000	1060	ARCO N° 13 - 25 X 45 X 220 cm		254,39
19080512	1000	1060	PILASTRA N° 12 - 3 X 25 X 101		21,51
19080513	1000	1060	PILASTRA N° 13 - 3 X 25 X 101		21,51
19080514	1000	1060	PILASTRA N° 14 - 3 X 25 X 101		21,51
19080515	1000	1060	PILASTRA N° 15 - 3 X 25 X 101		21,51

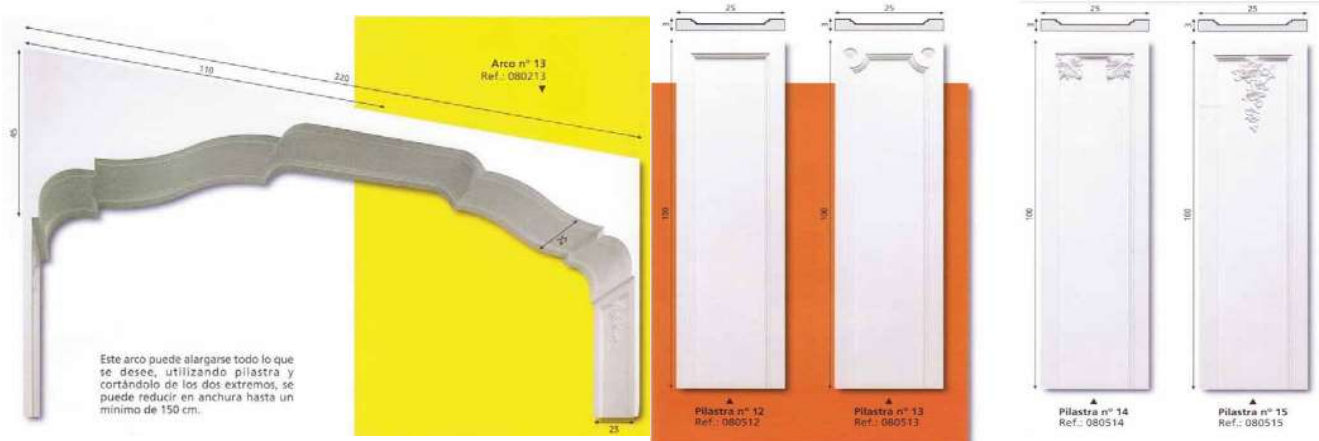

19080214	1000	1060	ARCO N° 14 - 15 X 30 X 120 cm		97,85
19080516	1000	1060	PILASTRA N° 16 - 3 X 15 X 111		16,91
19080517	1000	1060	PILASTRA N° 17 - 3 X 15 X 111		16,91



TARIFA PREFABRICADOS PVP 2.017

CODIGO	FAMILIA	SUBFAMILIA	PRODUCTO	CC	PVP 2017
19080215	1000	1060	ARCO N° 15 - 20 X 50 X 140 cm		219,14
19080518	1000	1060	PILASTRA N° 18 - 3 X 20 X 111		18,97
19080519	1000	1060	PILASTRA N° 19 - 3 X 20 X 111		18,16
19080520	1000	1060	PILASTRA N° 20 - 3 X 20 X 100		18,96



ARCOS COMBINADO LISO 7,5 CM

UD

19080927	1000	1060	CANET N° 27 - 50.5 X 7.5 X 50.5		43,25
19080521	1000	1060	PILASTRA N° 21 - 4 X 7.5 X 110		14,04

ARCOS COMBINADO LISO 10 CM

UD

19080928	1000	1060	CANET N° 28 - 50.5 X 10.5 X 50.5		18,69
19080522	1000	1060	PILASTRA N° 22 - 4 X 10.5 X 110		14,04

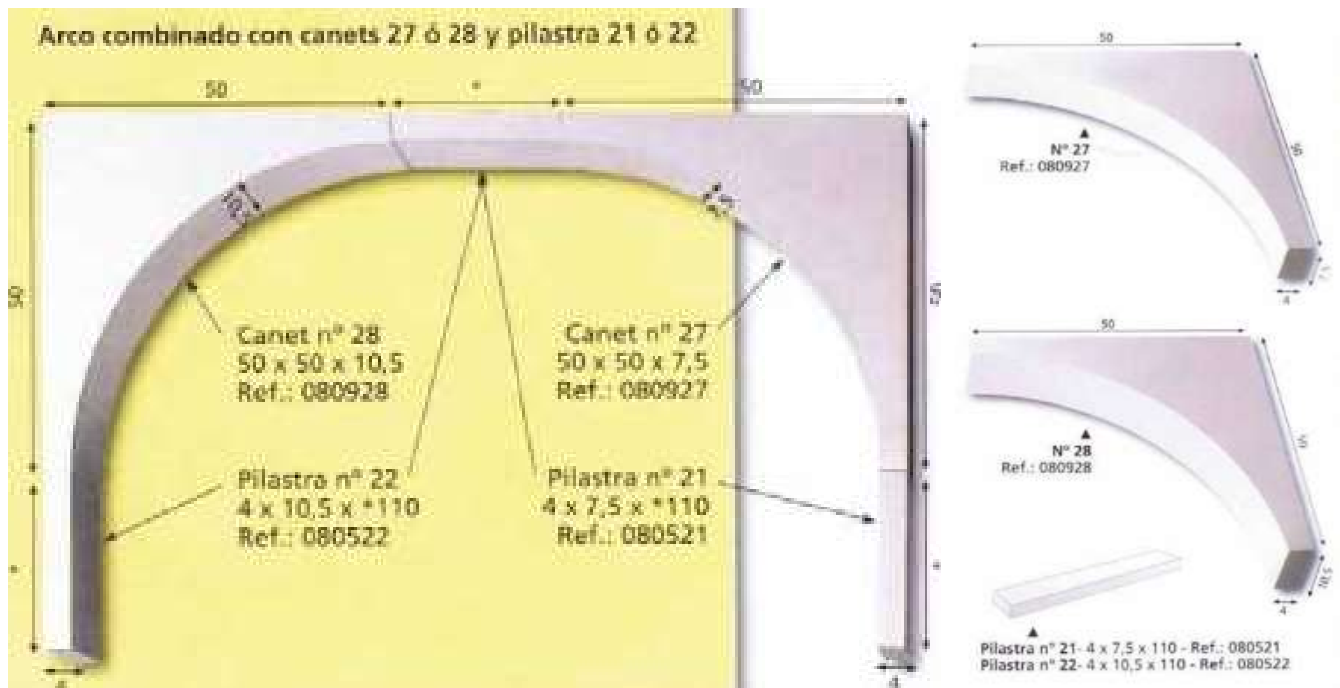

TARIFA PREFABRICADOS PVP 2.017

CODIGO	FAMILIA	SUBFAMILIA A	PRODUCTO	CC	PVP 2017
<u>PILASTRAS ALTERON</u>					<u>UD</u>
19080500	1000	1060	PILASTRA Nº 1 - 100X6,5		6,64
19080501	1000	1060	PILASTRA CON FLOR Nº 1 - 110X15		17,44
19080502	1000	1060	PILASTRA CON FLOR Nº 2 - 110X15		17,44
19080503	1000	1060	PILASTRA Nº 3 - 110X15		16,91
19080504	1000	1060	PILASTRA LISA Nº 4 - 100X25		21,51
19080555	1000	1060	DOBLE PILASTRA Nº 5 - 100X40		56,53
19080605	1000	1060	ALARGADERA Nº 5 - 100X35		41,41
19080606	1000	1060	ALARGADERA Nº 6 - 100X35		41,41
19080506	1000	1060	PILASTRA Nº 6 - 110X14		15,31
19080546	1000	1060	PILASTRA BASE Nº 6 - 100X14		25,82
19080547	1000	1060	PILASTRA CAPITEL Nº 6 - 100X14		33,67
19080607	1000	1060	PILASTRA ALARGADERA Nº 7 - 100X15		41,41
19080507	1000	1060	PILASTRA COLUMNA Nº 7 - 100X15		66,23
19080508	1000	1060	PILASTRA Nº 8 - 100X20		18,76
19080509	1000	1060	PILASTRA BASE Nº 9 - 100X20		60,61
19080559	1000	1060	PILASTRA CAPITEL Nº 9 - 100X20		60,61
19080609	1000	1060	PILASTRA ALARGADERA Nº 9 - 100X20		31,45
19080510	1000	1060	PILASTRA Nº 10 - 3X10X100		15,31
19080511	1000	1060	PILASTRA Nº 11 - 3X10X100		15,31
19080512	1000	1060	PILASTRA Nº 12 - 3 X 25 X 101		21,51
19080513	1000	1060	PILASTRA Nº 13 - 3 X 25 X 101		21,51
19080514	1000	1060	PILASTRA Nº 14 - 3 X 25 X 101		21,51
19080515	1000	1060	PILASTRA Nº 15 - 3 X 25 X 101		21,51
19080516	1000	1060	PILASTRA Nº 16 - 3 X 15 X 111		16,91
19080517	1000	1060	PILASTRA Nº 17 - 3 X 15 X 111		16,91
19080518	1000	1060	PILASTRA Nº 18 - 3 X 20 X 111		18,97
19080519	1000	1060	PILASTRA Nº 19 - 3 X 20 X 111		18,16
19080520	1000	1060	PILASTRA Nº 20 - 3 X 20 X 100		18,96
19080521	1000	1060	PILASTRA Nº 21 - 4 X 7.5 X 110		14,04
19080522	1000	1060	PILASTRA Nº 22 - 4 X 10.5 X 110		14,04
19080523	1000	1060	PILASTRA Nº 23 - 7 X 100		12,32
19080524	1000	1060	PILASTRA Nº 24 - 3 X 12 X 110		14,80
19080525	1000	1060	PILASTRA Nº 25 - 4 X 18 X 100		17,00
19080526	1000	1060	PILASTRA Nº 26 - 12 X 18 X 100		31,45

TARIFA PREFABRICADOS PVP 2.017

CODIGO	FAMILIA	SUBFAMILIA	PRODUCTO	CC	PVP 2017
--------	---------	------------	----------	----	----------

CANETS ALTERON

UD

19080901	1000	1060	CANET Nº 1 - 50X24X15		19,97
19080902	1000	1060	CANET Nº 2 - 24X15		18,73
19080903	1000	1060	CANET Nº 3 - 18X11X14		14,14
19080904	1000	1060	CANET Nº 4 - 40X33X6		18,73



19080954	1000	1060	DOBLE CANET Nº 4 - 40X25		38,91
19080955	1000	1060	DOBLE CANET Nº 5 - 40X35		42,71

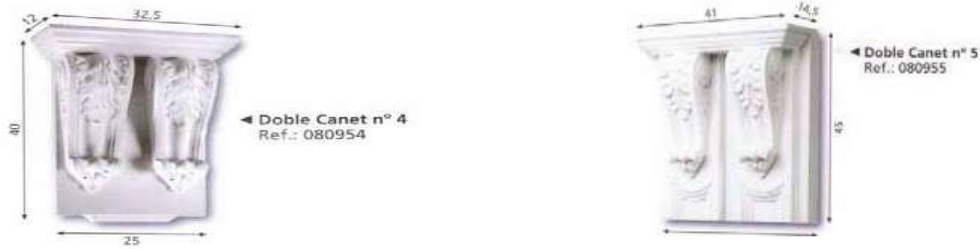

19080905	1000	1060	CANET Nº 5 - 20X17X6		14,14
19080906	1000	1060	CANET Nº 6 - 17X6,5		9,37
19080907	1000	1060	CANET Nº 7 - 32X23X20		21,20
19080908	1000	1060	CANET Nº 8 - 10X22X6		15,79



19080909	1000	1060	CANET Nº 9 - 30X17X7		15,79
19080910	1000	1060	CANET Nº 10 - 42X17X10		18,71
19080911	1000	1060	CANET Nº 11 - 35X19X30		19,22
19080912	1000	1060	CANET Nº 12 - 56X37X43		93,73



TARIFA PREFABRICADOS PVP 2.017

CODIGO	FAMILIA	SUBFAMILIA	PRODUCTO	CC	PVP 2017
19080914	1000	1060	CANET Nº 14 - 30X10X53		20,31
19080915	1000	1060	CANET Nº 15 - 30X14X40		20,31
19080916	1000	1060	CANET Nº 16 - 40X22		11,20
19080917	1000	1060	CANET Nº 17 - 30,5X13,5		11,20
19080918	1000	1060	CANET Nº 18 - 4X8X8X4		9,37

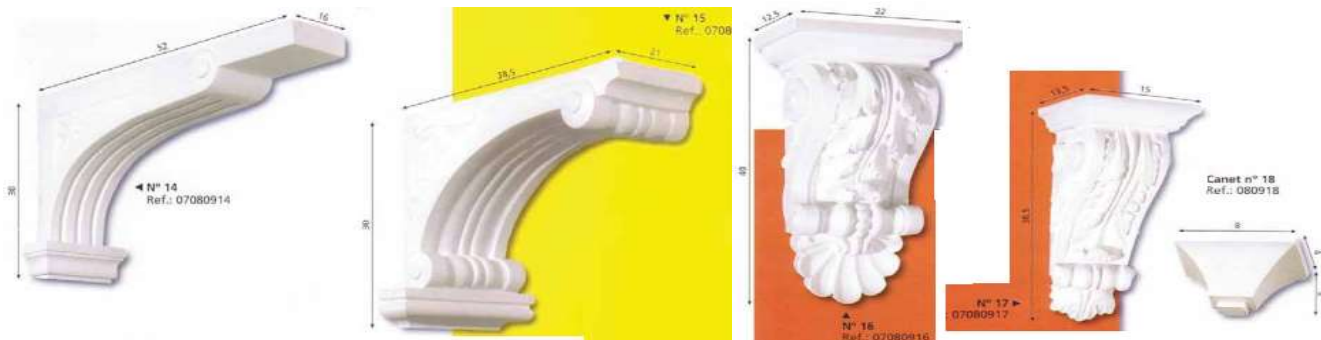

19080919	1000	1060	CANET Nº 19 - 9 X 11 X 22		19,53
19080920	1000	1060	CANET Nº 20 - 33 X 16.5 X 22		24,68
19080921	1000	1060	CANET Nº 21 - 15.5 X 6 X 15.5		11,14
19080922	1000	1060	CANET Nº 22 - 31.5 X 19.5 X 50		36,45
19080923	1000	1060	CANET Nº 23 - 25 X 12 X 13.5		17,28



19080924	1000	1060	CANET Nº 24 - 41 X 23 X 18.5		62,36
19080925	1000	1060	CANET Nº 25 - 32.5 X 7 X 32		23,70
19080926	1000	1060	CANET Nº 26 - 35 X 7 X 50		26,75



TARIFA PREFABRICADOS PVP 2.017

CODIGO	FAMILIA	SUBFAMILIA	PRODUCTO	CC	PVP 2017
19080927	1000	1060	CANET Nº 27 - 50.5 X 7.5 X 50.5		43,25
19080928	1000	1060	CANET Nº 28 - 50.5 X 10.5 X 50.5		18,69

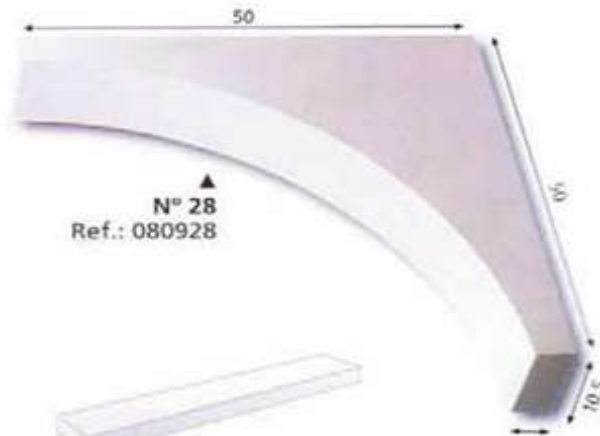
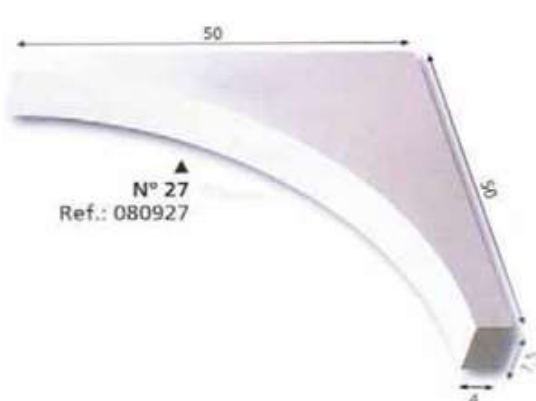

19080929	1000	1060	CANET Nº 29 - 23 X 11 X 11		18,69
19080930	1000	1060	CANET Nº 30 - 25 X 15 X 13		18,69
19080931	1000	1060	CANET Nº 31 - 17 X 10 X 7		17,28
19080932	1000	1060	CANET Nº 32 - 17 X 10 X 7		17,28



BASES ALTERÓN

UD

19081054	1000	1060	BASE ARCO Nº 4		16,04
19081055	1000	1060	BASE ARCO Nº 5		18,73



TARIFA PREFABRICADOS PVP 2.017

CODIGO	FAMILIA	SUBFAMILIA A	PRODUCTO	CC	PVP 2017
COLUMNAS EL ALTERON					UD
19081110	1000	1060	COLUMNA DÓRICA LISA 204 CM		512,79
19081111	1000	1060	COLUMNA DÓRICA ESTRIADA 204 CM		512,79
19081112	1000	1060	COLUMNA JÓNICA LISA 152 CM		344,48
19081113	1000	1060	COLUMNA JÓNICA ESTRIADA 87 CM		281,85
19081114	1000	1060	COLUMNA JÓNICA ESTRIADA 206 CM		528,44
19081115	1000	1060	COLUMNA JÓNICA LISA 206 CM		528,44
19081116	1000	1060	COLUMNA COMPUESTA LISA 212 CM		575,45
19081117	1000	1060	COLUMNA COMPUESTA ESTR. 212 CM		575,45
19081118	1000	1060	COLUMNA COMPUESTA ESTR. 92 CM		301,40

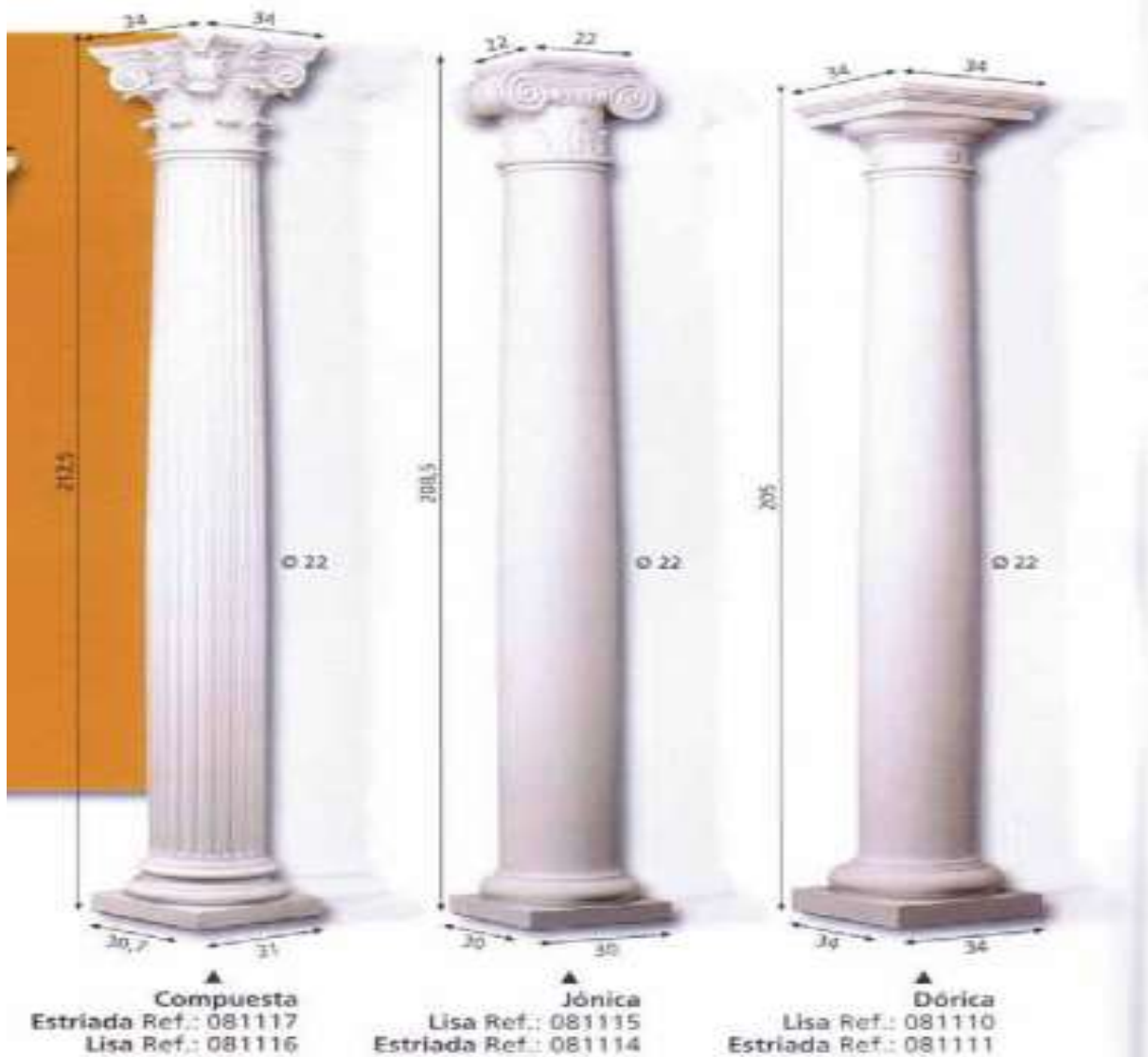

TARIFA PREFABRICADOS PVP 2.017

CODIGO	FAMILIA	SUBFAMILIA	PRODUCTO	CC	PVP 2017
19081120	1000	1060	PEDESTAL CUADRADO Nº 1		301,40
19081121	1000	1060	PEDESTAL CUADRADO Nº 2		301,40
19081140	1000	1060	CAPITEL GRANDE - 122X75		1.176,98
19081141	1000	1060	FUSTE 200X50		313,16
19081142	1000	1060	BASE 32X72		196,12



www.galuso.gal

TARIFA PREFABRICADOS PVP 2.017

CODIGO	FAMILIA	SUBFAMILIA	PRODUCTO	CC	PVP 2017
19081101	1000	1060	COLUMNA ESTRIADA PARTIDA 60 CM		293,55
19081102	1000	1060	COLUMNA ESTRIADA PARTIDA 90 CM		293,55
19081103	1000	1060	COLUMNA ESTRIADA PARTIDA 110 CM		293,55
19081104	1000	1060	COLUMNA ESTRIADA PARTIDA 135 CM		293,55
19081105	1000	1060	COLUMNA ESTRIADA TRUNCADA 60 CM		293,55
19081106	1000	1060	COLUMNA ESTRIADA TRUNCADA 90 CM		293,55
19081108	1000	1060	COLUMNA ESTRIADA TRUNCADA 110 CM		293,55
19081109	1000	1060	COLUMNA ESTRIADA TRUNCADA 135 CM		293,55
19081131	1000	1060	COLUMNA MESA 72 CM		277,92
19081132	1000	1060	COLUMNA MESA 42 CM		262,28
19081133	1000	1060	COLUMNA TOSCANA LISA 112 CM		266,15
19081136	1000	1060	COLUMNA MESA 90 CM		301,40

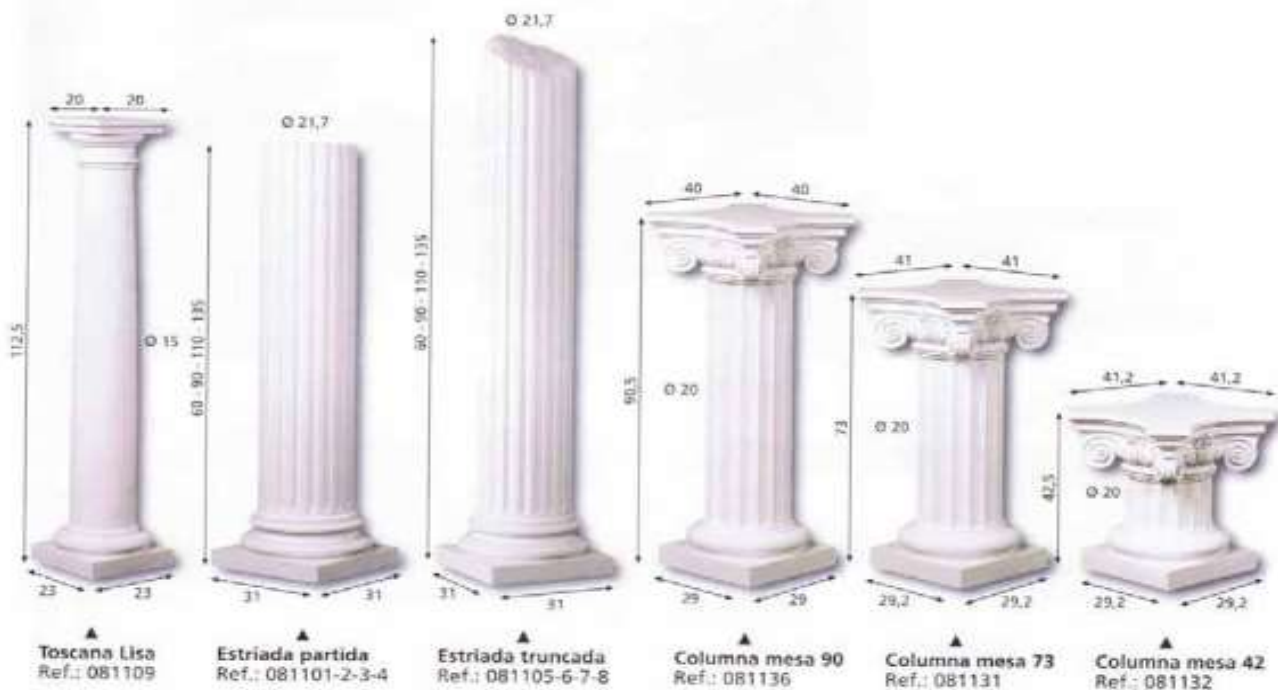

19081501	1000	1060	CONSOLA Nº 1 - 52X41X20,5		183,59
19081502	1000	1060	CONSOLA Nº 2 - 63X35X25		183,59
19081503	1000	1060	CONSOLA MEDIO CAPITEL - 92X48X75,5		592,64

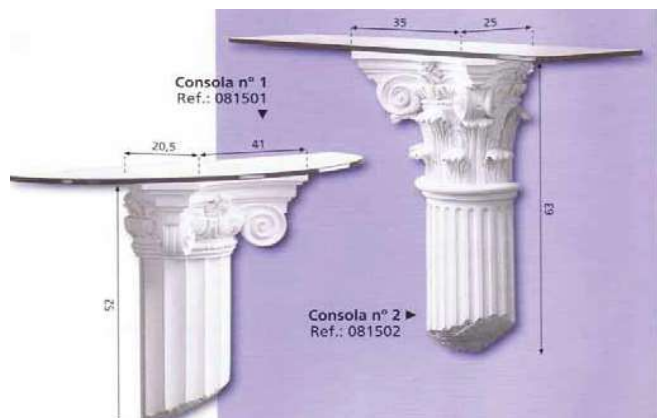

TARIFA PREFABRICADOS PVP 2.017

CODIGO	FAMILIA	SUBFAMILIA	PRODUCTO	CC	PVP 2017
COLUMNAS COMBINADAS					UD
19010901	1000	1060	BASE 9 CM		26,25
19010905	1000	1060	CAPITEL DECORADO 9 CM		26,25
19010916	1000	1060	FUSTE ESTRIADO 9 CM - 1,6 M		70,00
19010920	1000	1060	FUSTE LISO / ESTRIADO 9 CM - 2 M		101,50
19010930	1000	1060	FUSTE LISO 9 CM - 1,6 M		70,00
19011401	1000	1060	BASE 14/16 CM		52,50
19011405	1000	1060	CAPITEL DECORADO 14 CM		52,50
19011406	1000	1060	CAPITEL LISO 14 CM		52,50
19011416	1000	1060	FUSTE ESTRIADO 14 CM - 1,6 M		105,00
19011426	1000	1060	FUSTE LISO 14 CM - 1,6 M		105,00
19011420	1000	1060	FUSTE LISO / ESTRIADO 14 CM - 2 M		157,50
19011605	1000	1060	CAPITEL DECORADO 16 CM		52,50
19011606	1000	1060	CAPITEL LISO 16 CM		52,50
19011616	1000	1060	FUSTE ESTRIADO 16 CM - 1,6 M		122,50
19011620	1000	1060	FUSTE LISO / ESTRIADO 16 CM - 2 M		168,00
19011626	1000	1060	FUSTE LISO 16 CM - 1,6 M		122,50
19011801	1000	1060	BASE 18 CM		63,00
19011805	1000	1060	CAPITEL DECORADO 18 CM		63,00
19011806	1000	1060	CAPITEL LISO 18 CM		63,00
19011816	1000	1060	FUSTE LISO / ESTRIADO 18 CM - 1,6 M		133,00
19011820	1000	1060	FUSTE LISO / ESTRIADO 18 CM - 2 M		175,00
19012001	1000	1060	BASE 22 CM		63,00
19012006	1000	1060	CAPITEL LISO 22 CM		63,00
19012016	1000	1060	FUSTE LISO / ESTRIADO 22 CM - 1,6 M		157,50
19012028	1000	1060	FUSTE LISO / ESTRIADO 22 CM - 2 M		210,00
19013006	1000	1060	BASE 30 CM		98,00
19013006	1000	1060	CAPITEL LISO 30 CM		77,00
19013016	1000	1060	FUSTE LISO / ESTRIADO 30 CM - 1,6 M		192,50
19013020	1000	1060	FUSTE LISO / ESTRIADO 30 CM - 2 M		280,00



TARIFA PREFABRICADOS PVP 2.017

CODIGO	FAMILIA	SUBFAMILIA	PRODUCTO	CC	PVP 2017
CHIMENEAS					
19081301	1000	1060	CHIMENEA Nº 1 - 117 X 156 X 21,2		1.092,05
19081302	1000	1060	CHIMENEA Nº 2 - 117 X 156 X 21,2		1.092,05

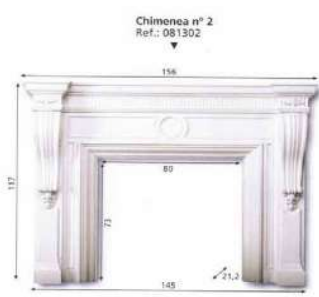
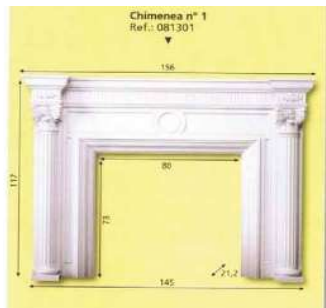

APLIQUES DE LUZ ALTERON

18070111	1000	1060	APLIQUE DE LUZ Nº 1	56,77
18070112	1000	1060	APLIQUE DE LUZ Nº 2	56,77
18070113	1000	1060	APLIQUE DE LUZ Nº 3	56,77
18070114	1000	1060	APLIQUE DE LUZ Nº 4	56,77
18070115	1000	1060	APLIQUE DE LUZ Nº 5	56,77
18070116	1000	1060	APLIQUE DE LUZ Nº 6 (CONCHA LUZ)	56,77
18070117	1000	1060	APLIQUE DE LUZ Nº 7	56,77
18070118	1000	1060	APLIQUE DE LUZ Nº 8	56,77

