

RIELES PARA CORTINAS PRESENTANDO EL NUEVO CATÁLOGO 2017



Desde 1973





Diseño, calidad e innovación desde 1973





**APOSTAMOS POR LA CALIDAD, EL DISEÑO Y LA INNOVACIÓN TECNOLÓGICA PARA OFRECER PRODUCTOS CAPACES DE CUMPLIR CON TODAS SUS EXPECTATIVAS.**

Tras casi cuatro décadas de continuo crecimiento, **RIEL CHYC** es, hoy en día, uno de los referentes indiscutibles en el mundo del riel y un interlocutor privilegiado en el segmento de la decoración para el hogar.

Nuestra misión como empresa nos ha llevado a desarrollar y producir aquellos productos que nos **hubiese gustado instalar** como profesionales pero, también, **disfrutar** como usuarios.

Gracias a esta doble identificación hemos ido tejiendo una **verdadera relación de confianza** con nuestros clientes, haciendo nuestros sus objetivos e inquietudes y acompañándolos en sus éxitos.

En **RIEL CHYC** estamos permanentemente a la escucha de las necesidades de un mercado, cada día más cambiante, anticipándonos a sus tendencias, apostando por tecnologías limpias y eficientes para ofrecer **soluciones pertinentes e innovadoras, originales y personalizables, y con valores añadidos contrastados y medibles.**

Todas ellas, están presente en la tarifa-catálogo que tiene en sus manos y que le invitamos a descubrir.





*Nuestra meta es ser, diariamente, una empresa "excelente" en todas sus áreas, el I+D+I, la producción, la logística, el marketing y el servicio pre y post-venta.*



*Esta mejora continua de nuestros procesos, avalada por la certificación de la ISO 9001, constituye, para nuestros clientes, la mejor de las garantías.*



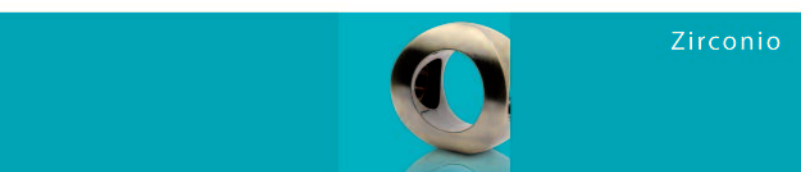

## Zirconio

Tubo y accesorios Ø28 mm	10/18
Tubo y accesorios Ø20 mm	19/30
Tubo abierto Ø20 mm	31/34
Tubo y accesorios Ø12 mm	35
Accesorios comunes	36
Tubo y accesorios 20x20 mm	37/39



## Gama Elite

Tubo y accesorios Ø28 mm	42/48
Tubo y accesorios Ø20 mm	42/48



## Forja

Tubo y accesorios Ø28 mm	52/57
Tubo y accesorios Ø20 mm	58/66
Tubo y accesorios Ø12 mm	67/68
Accesorios comunes	69/70



## Madera

Barra y accesorios Ø50 mm	74/79
Barra y accesorios Ø35 mm	80/84
Barra y accesorios Ø28 mm	85/91
Barra y accesorios Ø20 mm	91/94
Barra y accesorios Ø12 mm	95/96
Accesorios comunes	97/98



## Gama Infantil

Barra de madera y anilla	102
Accesorios	103/105







## Panel japonés

Panel japonés a medida	108
Panel japonés en blister	109
Accesorios para panel	109/114
Estor y accesorios	115



## Estores

Con mando a cadenilla	118/126
Accesorios comunes	127/131
Con mando a cordón	132/140
Accesorios comunes	141/144
Dispositivos de seguridad	145/146

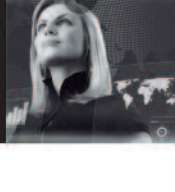
		<p><b>Aluminio</b> Motorización de cortinas</p>	<p>Rieles y pefiles sin cinta gancho 150/184 Rieles y pefiles con cinta gancho 185/186 Accesorios comunes 187/191 Curvado de perfiles 192/193 Motorización de cortinas SOMFY 195/204 Motorización de cortinas CHYC 205/209</p>
		<p><b>Baño</b></p>	<p>Barras extensibles y curvas 212 Accesorios 212</p>
		<p><b>Hierro lacado</b></p>	<p>Rieles extensibles 214/215 Accesorios 215/220 Herramientas y tornillos 220/221</p>
		<p><b>Portavisillos</b></p>	<p>Portavisillos y accesorios 224/227 Portavisillos de forja 228 Línea "Chy-Cort" 229/231 Tubos y accesorios para armario 232</p>
		<p><b>Complementos</b></p>	<p>Galerías para rieles 234/235 Recoge-cortinas 236/239 Alzapaños y ganchos 239/244 Cintas, fruncidoras, armadoras 245/251 Tiradores, compl. para escalera 252/255 Ollaos para cortinas, escaleras 256/257</p>
		<p><b>A medida</b></p>	<p>Estores 260/268 Rieles de aluminio 269/277 Rieles de hierro lacado 278</p>
		<p><b>Muestrarios</b></p>	<p>Muestrarios 280/284 Cabezales 285 Expositores y separadores 286/287</p>
		<p><b>Hojas de pedido</b></p>	<p>Panel japonés 290 Galerías 291 Estores 292 Estores enrollables 293 Riel hierro lacado 294 Riel aluminio 295 Riel ondas 296 Perfiles curvados 297 Riel motorizado 298</p>



Para **Riel Chyc**, tan importante es el diseño y la calidad de nuestros artículos como la eficiencia con la que los servimos a nuestros clientes. Por ello, hemos diseñado nuestra tarifa-catálogo para que sea una herramienta de trabajo **eficaz, ágil y práctica de usar.**

## CONDICIONES GENERALES

### PRECIOS DE VENTA AL PÚBLICO P.V.P. (IVA NO INCLUIDO)

- En todos los pedidos deberán indicar el código del artículo según la "TARIFA/ CATÁLOGO", y en lo posible, rogamos se realicen por Fax o Correo electrónico.
- Pedido mínimo 60 €.
- Pago mediante giro domiciliado a 30 días fecha factura.
- Caso de impago de giros, los gastos irán por cuenta y riesgo del cliente.
- La reserva de dominio será de Riel Chyc hasta el pago total de la mercancía.
- Riel Chyc podrá, sin previo aviso, modificar sus artículos o precios de venta.
- Jurisdicción: El comprador acepta en caso de desavenencia la jurisdicción de los tribunales de Alicante, con renuncia expresa a cualquier otro.
- Los envíos se efectuarán a portes debidos, salvo pacto expreso en contrario.
- Cualquier anomalía respecto a la mercancía recibida (cantidad o diferencia de producto) deberá comunicarse a Riel Chyc en el plazo máximo de DIEZ DÍAS, de la recepción de la mercancía, en caso contrario declinamos toda responsabilidad.
- Los perfiles y rieles superiores a 4 m. se servirán siempre que exista servicio de transportes para la zona de destino y en plazo de servicio de una semana superior a nuestro servicio estándar, pudiendo repercutir un recargo en concepto de portes.
- A petición del cliente se podrán cortar barras o perfiles a 1€ corte/unidad.

### ATENCIÓN, MUY IMPORTANTE: "RECLAMACIÓN TRANSPORTISTA"

- Cuando la mercancía llegue incompleta o en mal estado, **(ES NECESARIO COMPROBAR EL ESTADO DE LA MERCANCÍA ANTES DE QUE SE VAYA EL TRANSPORTISTA)**. Se deberá hacer constar en el albarán de entrega del transportista, responsable de esta anomalía, **SIN ESTE REQUISITO RIEL CHYC NO SE HARÁ CARGO DE POSIBLES RECLAMACIONES.**
- Si hubiese alguna incidencia motivada por el transporte deberá informar a Riel Chyc en un plazo no superior a las 24 horas después de haber recibido el pedido.



## LEYENDAS Y SÍMBOLOS

### FORMATOS:



### CARACTERÍSTICAS:



### CÓDIGOS DE ENVASADO

GRANEL .....	0
CAJA CARTÓN .....	1
BLISTER .....	2
SKIN/ RETRÁCTIL .....	3
BOLSA DE PROTECCIÓN .....	4
BOLSA-CARTÓN .....	5
OTROS .....	9

### ESQUEMA DE COMPOSICIÓN DE LAS REFERENCIA

Ejemplos	Producto	Color	Envasado
REF:			
1321064	Riel madera 1,50 m. <b>1321</b>	Blanco <b>06</b>	Bolsa <b>4</b>
0706062	Riel madera 3,60 m. <b>0706</b>	Blanco <b>06</b>	Blister <b>2</b>

## CÓDIGOS DE COLORES

NATURAL.....	00	NÍQUEL-NEGRO .....	50
NOGAL .....	01	TITANIO MATE .....	51
PINO.....	02	PERLA .....	60
TECA .....	03	VERDI-NEGRO .....	61
ROBLE .....	04	MARFIL-ORO .....	62
CORINTO .....	05	ÓXIDO .....	63
BLANCO .....	06	AZUL-BLANCO .....	65
NEGRO .....	07	AMARILLO-DORADO ...	66
CAOBA .....	09	SALMÓN-ORO .....	68
WENGUE .....	10	NEGRO-DORADO .....	69
CEREZO .....	11	GRAFITO .....	70
CENIZA .....	12	BLANCO-DORADO .....	71
TRANSPARENTE .....	20	NEGRO-COBRE .....	72
BEIS .....	21	NEGRO-PLATA .....	73
AZUL CLARO .....	22	VERDE-DORADO .....	74
VERDE CLARO .....	23	ROJO-DORADO .....	75
ORO .....	24	ARCILLA .....	76
NARANJA .....	26	CHOCOLATE .....	77
MARRÓN .....	27	MIEL .....	78
VERDE .....	31	CREMA .....	79
GRIS .....	32	ANIS .....	80
MARFIL .....	33	SABLE .....	81
GRANATE .....	37	LIMÓN .....	82
CINCADO, PLATA .....	40	FUCSIA .....	83
COBRE-VIEJO .....	41	NÁCAR .....	84
NÍQUEL MATE .....	42	ZAFIRO .....	86
CROMADO .....	43	BLANCO-DORADO .....	87
DORADO .....	44	BLANCO-PLATA .....	88
BRONCE SATINADO ....	46	CREMA-PLATA .....	89
BRONCE VIEJO.....	47	MULTICOLOR .....	99
ACERO INOXIDABLE ....	49		

## ESQUEMAS MEDIDAS

### EJEMPLOS DE MEDIDAS MÁXIMAS Y FUNCIONALES

(Las medidas están todas en milímetros, salvo indicación concreta que se especificará la unidad utilizada)

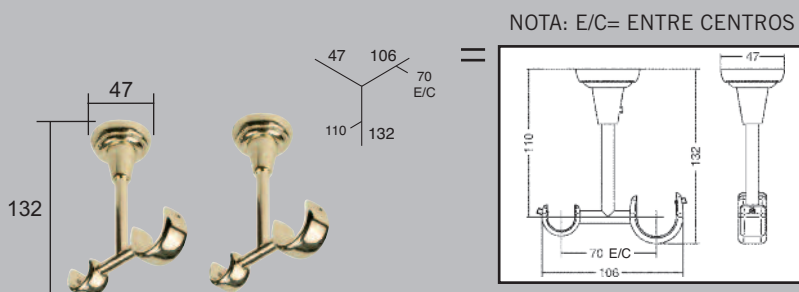



# Zirconio

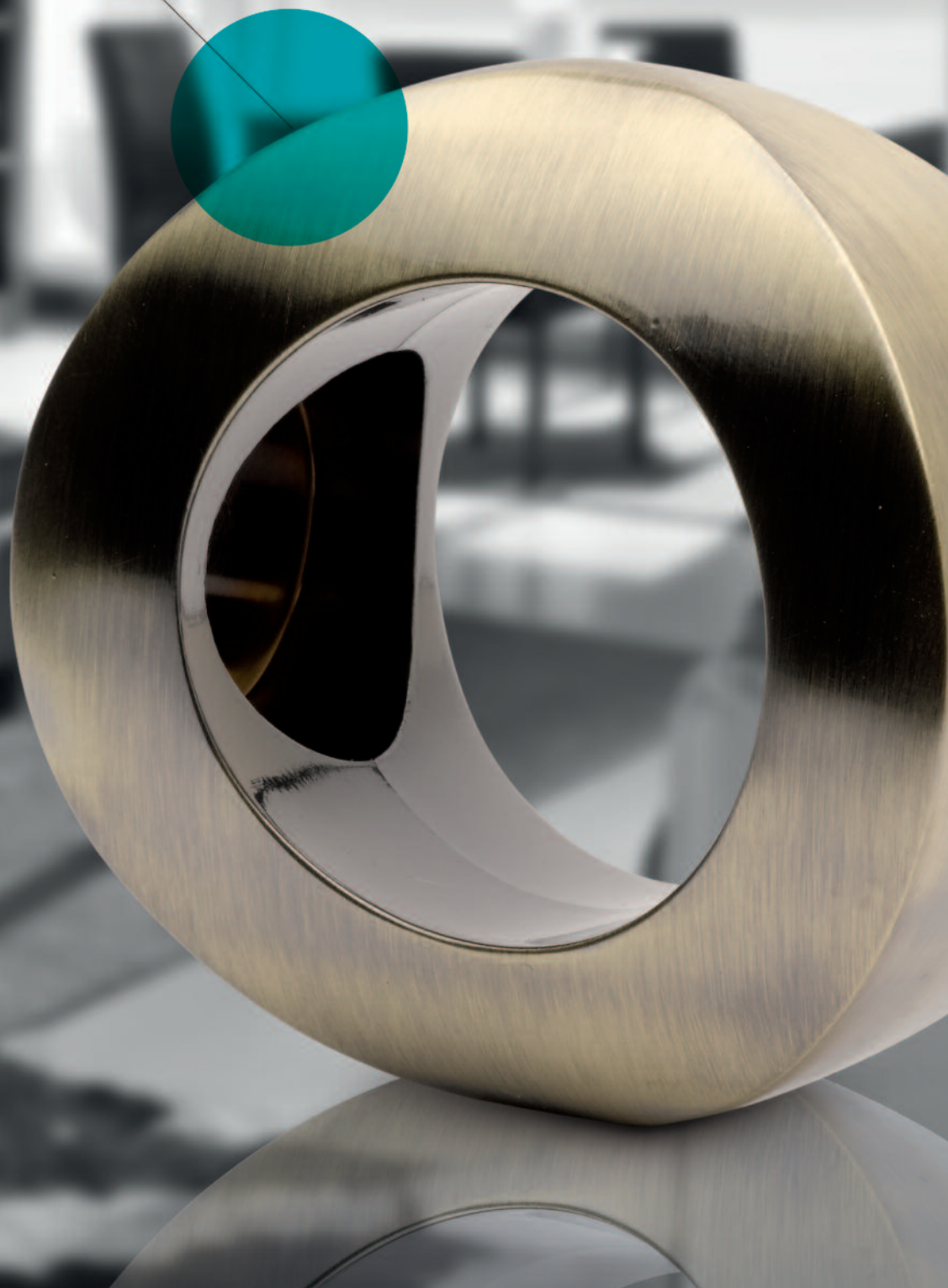



# COLORES



**42.**  
NÍQUEL mate



**43.**  
CROMADO



HASTA FIN DE EXISTENCIAS

**44.**  
DORADO



HASTA FIN DE EXISTENCIAS

**46.**  
BRONCE satinado



**47.**  
BRONCE viejo



**50.**  
NÍQUEL negro



**51.**  
TITANIO mate

## TUBO ZIRCONIO Ø28 mm.



REFERENCIA	←----→		NÍQUEL mate	CROMADO	DORADO	BRONCE satinado	BRONCE viejo	NÍQUEL negro	TITANIO mate
4482**3	1,50 m.	x 6	17,23 €/u.	17,56 €/u.	17,56 €/u.	17,56 €/u.	17,56 €/u.	17,56 €/u.	17,56 €/u.
4483**3	2,00 m.	x 6	22,85 €/u.	23,25 €/u.	23,25 €/u.	23,25 €/u.	23,25 €/u.	23,25 €/u.	23,25 €/u.
4484**3	2,50 m.	x 6	28,41 €/u.	28,96 €/u.	28,96 €/u.	28,96 €/u.	28,96 €/u.	28,96 €/u.	28,96 €/u.
4485**3	3,00 m.	x 6	33,96 €/u.	36,01 €/u.	36,01 €/u.	36,01 €/u.	36,01 €/u.	36,01 €/u.	36,01 €/u.

NOTA: Corte de barra 1 € (Referencia 9999989)

\*\* Colores: **42=** Níquel mate. **43=** Cromado. **44=** Dorado. **46=** Bronce satinado. **47=** Bronce viejo. **50=** Níquel negro. **51=** Titanio mate. Código de envasado: **3=** Skin.



# ACCESORIOS

ANILLA PLANA  
CON SILENCIADOR



Ø IN. 39  
Ø EX. 48

ANILLA  
CON SILENCIADOR



Ø IN. 44  
Ø EX. 60

CODO GIRATORIO  
(No disponible en níquel negro)



33  
55 55

REF.	4481**2	4481**4	4598**2	4598**4	4568**2	4568**4
	x 10	x 1	x 10	x 1	x 1	x 1
	x 10		x 10		x 10	
A	16,23 €/bl.	1,52 €/u.	8,49 €/bl.	0,80 €/u.	8,20 €/bl.	7,72 €/u.
B	16,57 €/bl.	1,56 €/u.	8,74 €/bl.	0,82 €/u.	8,34 €/bl.	7,88 €/u.

EMPALME TUBO



Ø27 120

SOPORTE CENTRAL



Ø47 155  
135

SOPORTE DOBLE CILÍNDRICO 28-28 mm.  
(Solo disponible en níquel mate y titanio mate)



Ø49 172  
64 152

REF.	4573402	4573404	4478**2	4478**4	4495**2	4495**4
	x 1	x 1	x 1	x 1	x 1	x 1
	x 10		x 10		x 10	
A	3,98 €/bl.	3,74 €/u.	9,14 €/bl.	8,62 €/u.	12,40 €/bl.	11,69 €/u.
B	-	-	9,32 €/bl.	8,78 €/u.	12,67 €/bl.	11,90 €/u.

SOPORTE DOBLE 28-28 mm.



Ø47 230  
110 210

SOPORTE DOBLE 28-20 mm.



Ø47 225  
103 203

REFUERZO PARA SOPORTE  
(No disponible en dorado y bronce satinado)



96  
Ø49 159

REF.	4491**2	4491**4	4490**2	4490**4	4424**4
	x 1	x 1	x 1	x 1	x 1
	x 10		x 10		
A	10,65 €/bl.	10,01 €/u.	10,64 €/bl.	10,00 €/u.	PROXIMAMENTE
B	10,87 €/bl.	10,19 €/u.	10,85 €/bl.	10,20 €/u.	

NOTA: Envasado en bolsa (.4), el pedido mínimo es de 10 unidades. Anillas en bolsa (.4), el pedido mínimo es de 100 unidades.

\*\* Colores A: 42= Níquel mate.

\*\* Colores B: 43= Cromado. 44= Dorado. 46= Bronce satinado. 47= Bronce viejo. 50= Níquel negro. 51= Titanio mate.

Código de envasado: 2= Blister. 4= Bolsa de protección.

ZIRCONIO Ø28 mm.



# ACCESORIOS

SOPORTE EXTENSIBLE

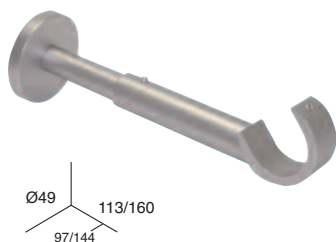

SOPORTE TECHO



SOPORTE TECHO DOBLE 28-20 mm.  
(No disponible en níquel negro y titanio mate)

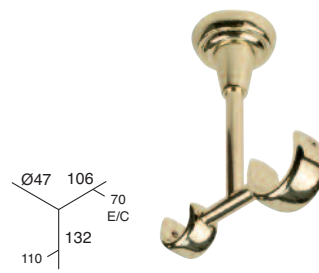

REF.	4487**2	4487**4	4479**2	4479**4	4594**2	4594**4
	x 1	x 1	x 1	x 1	x 1	x 1
	x 10		x 10		x 10	
A	11,50 €/bl.	10,81 €/u.	7,82 €/bl.	7,36 €/u.	10,67 €/bl.	10,01 €/u.
B	11,50 €/bl.	10,81 €/u.	8,03 €/bl.	7,56 €/u.	10,95 €/bl.	10,30 €/u.

SOPORTE TECHO ABIERTO LARGO  
(No disponible en dorado y bronce satinado)

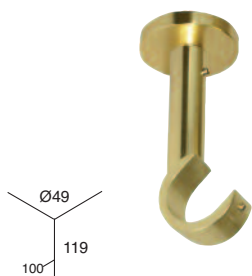

SOPORTE TECHO ABIERTO CORTO  
(No disponible en dorado y bronce satinado)

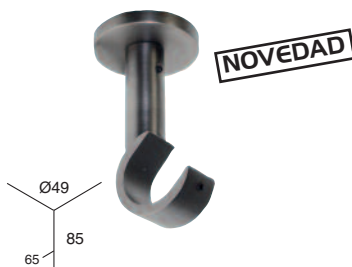

SOPORTE LATERAL



REF.	4807**2	4807**4	4585**2	4585**4	4480**2	4480**4
	x 1	x 1	x 1	x 1	x 1 juego	x 1 juego
	x 10		x 10		x 10	
A	10,79 €/bl.	10,16 €/u.	10,35 €/bl.	9,70 €/u.	7,06 €/bl.	6,65 €/juego
B	10,79 €/bl.	10,16 €/u.	10,35 €/bl.	9,70 €/u.	7,19 €/bl.	6,74 €/juego

# TERMINALES MONOCOLOR

TERMINAL TAPÓN

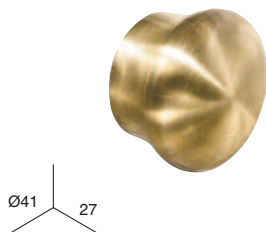

TERMINAL "REGENCY"  
(No disponible en bronce satinado)



TERMINAL "DAMA"



REF.	4537**2	4537**4	4837**2	4837**4	4475**2	4475**4
	x 2	x 1	x 1	x 1	x 1	x 1
	x 15		x 10		x 10	
A	8,17 €/bl.	3,85 €/u.	9,28 €/bl.	8,71 €/u.	11,27 €/bl.	10,58 €/u.
B	8,51 €/bl.	3,99 €/u.	9,44 €/bl.	8,88 €/u.	11,48 €/bl.	10,78 €/u.

NOTA: Envasado en bolsa (.4), el pedido mínimo es de 10 unidades. Anillas en bolsa (.4), el pedido mínimo es de 100 unidades.

\*\* Colores A: 42= Níquel mate.  
\*\* Colores B: 43= Cromado. 44= Dorado. 46= Bronce satinado. 47= Bronce viejo. 50= Níquel negro. 51= Titanio mate.  
Código de envasado: 2= Blister. 4= Bolsa de protección.



# TERMINALES MONOCOLOR

TERMINAL "ESFERA"

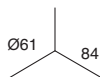

TERMINAL "COPA"



TERMINAL "MADRID"  
(No disponible en bronce satinado y titanio mate)



REF.	4476**2	4476**4	4477**2	4477**4	4488**2	4488**4
	x 1	x 1	x 1	x 1	x 1	x 1
	x 10		x 10		x 10	
A	11,27 €/bl.	10,58 €/u.	11,27 €/bl.	10,58 €/u.	14,07 €/bl.	13,23 €/u.
B	11,48 €/bl.	10,78 €/u.	11,48 €/bl.	10,78 €/u.	14,07 €/bl.	13,23 €/u.

TERMINAL "MÓDENA"

(No disponible en dorado y bronce satinado)

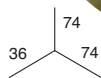

TERMINAL "LUGANO"

(No disponible en dorado y bronce satinado)



TERMINAL "SHANGHAI"

(No disponible en dorado y bronce satinado)



REF.	4835**2	4835**4	4626**2	4626**4	4625**2	4625**4
	x 1	x 1	x 1	x 1	x 1	x 1
	x 10		x 10		x 10	
A	9,65 €/bl.	9,06 €/u.	9,39 €/bl.	8,79 €/u.	9,33 €/bl.	8,76 €/u.
B	9,84 €/bl.	9,24 €/u.	9,68 €/bl.	9,10 €/u.	9,64 €/bl.	9,06 €/u.

# TERMINALES BICOLOR

TERMINAL "PRISMA"

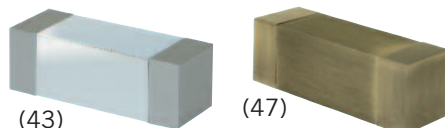

(43)

(47)

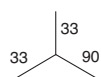
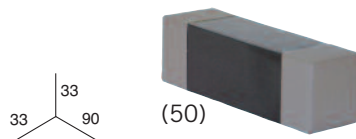

(50)

TERMINAL "PINZA"

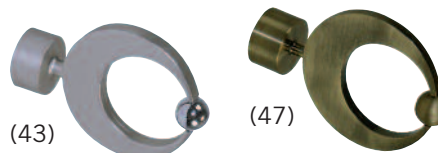

(43)

(47)

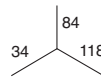

(50)

REF.	4833**2	4833**4	4839**2	4839**4
	x 1	x 1	x 1	x 1
	x 10		x 10	
43. Cromado/Níquel mate	11,20 €/bl.	10,53 €/u.	10,55 €/bl.	9,91 €/u.
47. Bronce viejo/Bronce viejo mate	11,20 €/bl.	10,53 €/u.	10,55 €/bl.	9,91 €/u.
50. Níquel negro/Níquel mate	11,20 €/bl.	10,53 €/u.	10,55 €/bl.	9,91 €/u.

NOTA: Envasado en bolsa (.4), el pedido mínimo es de 10 unidades. Anillas en bolsa (.4), el pedido mínimo es de 100 unidades.

\*\* Colores A: 42= Níquel mate.

\*\* Colores B: 43= Cromado. 44= Dorado. 46= Bronce satinado. 47= Bronce viejo. 50= Níquel negro. 51= Titanio mate.

Código de envasado: 2= Blister. 4= Bolsa de protección.



# TERMINALES DE CRISTAL

TERMINAL "SPACE"

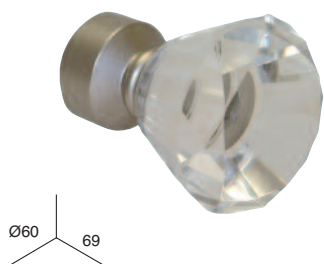

TERMINAL "ZAFIRO"  
(con tornillo)



TERMINAL "ELIPSE"



REF.	4801**2	4801**4	4711**2	4711**4	4725**2	4725**4
	x 1	x 1	x 1	x 1	x 1	x 1
	x 10		x 10		x 10	
42	13,29 €/bl.	12,49 €/u.	16,70 €/bl.	14,71 €/u.	10,51 €/bl.	9,89 €/u.
47	13,29 €/bl.	12,49 €/u.	16,70 €/bl.	14,71 €/u.	10,51 €/bl.	9,89 €/u.

Terminales de cristal: solo disponibles en colores níquel mate y bronce viejo.

# TERMINALES COMBINADOS CON MADERA

TERMINAL "ESFERA"



	REF.			€/blister	REF.		€/unidad
Níquel mate	4548**2	x 1	x 10	6,90 €/bl.	4548**4	x 1	6,51 €/u.
Cromado	4549**2	x 1	x 10	7,05 €/bl.	4549**4	x 1	6,62 €/u.
Dorado	4550**2	x 1	x 10	7,05 €/bl.	4550**4	x 1	6,62 €/u.
Bronce satinado	4551**2	x 1	x 10	7,05 €/bl.	4551**4	x 1	6,62 €/u.
Bronce Viejo	4552**2	x 1	x 10	7,05 €/bl.	4552**4	x 1	6,62 €/u.

TERMINAL "CAMPANA"



	REF.			€/blister	REF.		€/unidad
Níquel mate	4563**2	x 1	x 10	7,02 €/bl.	4563**4	x 1	6,60 €/u.
Cromado	4564**2	x 1	x 10	7,17 €/bl.	4564**4	x 1	6,73 €/u.
Dorado	4565**2	x 1	x 10	7,17 €/bl.	4565**4	x 1	6,73 €/u.
Bronce satinado	4566**2	x 1	x 10	7,17 €/bl.	4566**4	x 1	6,73 €/u.
Bronce Viejo	4567**2	x 1	x 10	7,17 €/bl.	4567**4	x 1	6,73 €/u.

NOTA: Envasado en bolsa (.4), el pedido mínimo es de 10 unidades. Anillas en bolsa (.4), el pedido mínimo es de 100 unidades.

\*\* Colores de la madera : 01= Nogal. 02= Pino. 03= Teca. 10= Wengue.  
Código de envasado: 2= Blister. 4= Bolsa de protección.





# SUGERENCIAS DE MONTAJE

(Con soporte frente 4478\*\*4)

COMPONENTES NECESARIOS			
REF. Tubo Ø28 (Skin)	Anillas 4598**4	Soporte 4478**4	Terminales
4482**3 (1,50 m.)	16 unidades	2 soportes	2 terminales
4483**3 (2,00 m.)	20 unidades	2 soportes	2 terminales
4484**3 (2,50 m.)	26 unidades	3 soportes	2 terminales
4485**3 (3,00 m.)	30 unidades	3 soportes	2 terminales

TERMINAL "ESFERA"



<---->	A	B
(1,50 m.)	68,43 €	69,80 €
(2,00 m.)	77,25 €	78,77 €
(2,50 m.)	96,23 €	98,18 €
(3,00 m.)	104,98 €	108,51 €

TERMINAL "COPA"

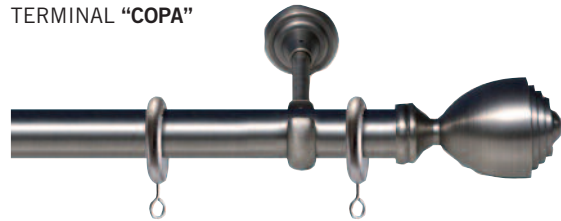

<---->	A	B
(1,50 m.)	68,43 €	69,80 €
(2,00 m.)	77,25 €	78,77 €
(2,50 m.)	96,23 €	98,18 €
(3,00 m.)	104,98 €	108,51 €

TERMINAL "DAMA"

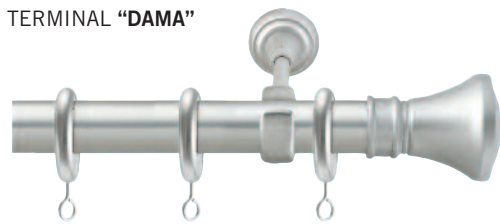

<---->	A	B
(1,50 m.)	68,43 €	69,80 €
(2,00 m.)	77,25 €	78,77 €
(2,50 m.)	96,23 €	98,18 €
(3,00 m.)	104,98 €	108,51 €

TERMINAL "MADRID"



<---->	42	43/ 44/ 47/ 50
(1,50 m.)	73,73 €	74,70 €
(2,00 m.)	82,55 €	83,67 €
(2,50 m.)	101,53 €	103,08 €
(3,00 m.)	110,28 €	113,41 €

TERMINAL "REGENCY"

(No disponible en 46)

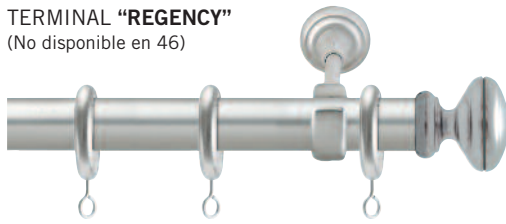

<---->	A	B
(1,50 m.)	64,69 €	66,00 €
(2,00 m.)	73,51 €	74,97 €
(2,50 m.)	92,49 €	94,38 €
(3,00 m.)	101,24 €	104,71 €

TERMINAL "MÓDENA"

(No disponible en 44 y en 46)



<---->	A	B
(1,50 m.)	65,39 €	66,72 €
(2,00 m.)	74,21 €	75,69 €
(2,50 m.)	93,19 €	95,10 €
(3,00 m.)	101,94 €	105,43 €

TERMINAL "LUGANO"

(No disponible en 44 y 46)

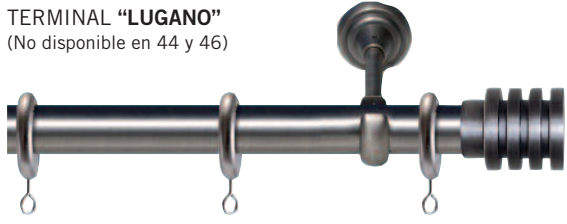

<---->	A	B
(1,50 m.)	64,85 €	66,44 €
(2,00 m.)	73,67 €	75,41 €
(2,50 m.)	92,65 €	94,82 €
(3,00 m.)	101,40 €	105,15 €

TERMINAL "SHANGHAI"

(No disponible en 44 y en 46)



<---->	A	B
(1,50 m.)	64,79 €	66,36 €
(2,00 m.)	73,61 €	75,33 €
(2,50 m.)	92,59 €	94,74 €
(3,00 m.)	101,34 €	105,07 €

\*\* Colores A: 42= Níquel mate.

\*\* Colores B: 43= Cromado. 44= Dorado. 46= Bronce satinado. 47= Bronce viejo. 50= Níquel negro. 51= Titanio mate.

# SUGERENCIAS DE MONTAJE

(Con soporte frente 4478\*\*4)

## COMPONENTES NECESARIOS

REF. Tubo Ø28 (Skin)	Anillas 4598**4	Soporte 4478**4	Terminales
4482**3 (1,50 m.)	16 unidades	2 soportes	2 terminales
4483**3 (2,00 m.)	20 unidades	2 soportes	2 terminales
4484**3 (2,50 m.)	26 unidades	3 soportes	2 terminales
4485**3 (3,00 m.)	30 unidades	3 soportes	2 terminales

TERMINAL BICOLOR "PRISMA"



<---->	43-42/ 47/ 50-42
(1,50 m.)	69,30 €
(2,00 m.)	78,27 €
(2,50 m.)	97,68 €
(3,00 m.)	108,01 €

TERMINAL "PINZA"



<---->	43-42/ 47/ 50-42
(1,50 m.)	68,06 €
(2,00 m.)	77,03 €
(2,50 m.)	96,44 €
(3,00 m.)	106,77 €

TERMINAL "TAPÓN"



<---->	A	B
(1,50 m.)	54,97 €	56,22 €
(2,00 m.)	63,79 €	65,19 €
(2,50 m.)	82,77 €	84,60 €
(3,00 m.)	91,52 €	94,93 €

TERMINAL "SPACE"

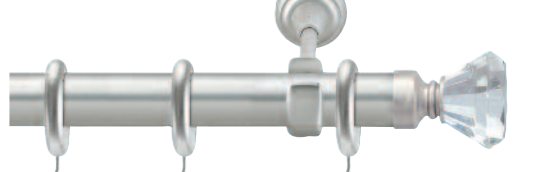

<---->	42	47
(1,50 m.)	72,25 €	73,22 €
(2,00 m.)	81,07 €	82,19 €
(2,50 m.)	100,05 €	101,60 €
(3,00 m.)	108,80 €	111,93 €

TERMINAL "ZAFIRO"

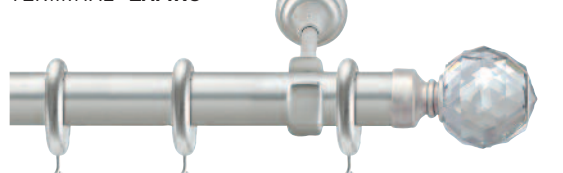

<---->	42	47
(1,50 m.)	76,69 €	77,66 €
(2,00 m.)	85,51 €	86,63 €
(2,50 m.)	104,49 €	106,04 €
(3,00 m.)	113,24 €	116,37 €

TERMINAL "ELIPSE"



<---->	42	47
(1,50 m.)	67,05 €	68,02 €
(2,00 m.)	75,87 €	76,99 €
(2,50 m.)	94,85 €	96,40 €
(3,00 m.)	103,60 €	106,73 €

TERMINAL "ESFERA"



<---->	42 + madera*	43/ 44/ 46/ 47 + madera*
(1,50 m.)	60,29 €	61,26 €
(2,00 m.)	69,11 €	70,23 €
(2,50 m.)	88,09 €	89,64 €
(3,00 m.)	96,84 €	99,97 €

TERMINAL "CAMPANA"



<---->	42 + madera*	43/ 44/ 46/ 47 + madera*
(1,50 m.)	60,47 €	61,44 €
(2,00 m.)	69,29 €	70,41 €
(2,50 m.)	88,27 €	89,82 €
(3,00 m.)	97,02 €	100,15 €

\*\* Colores A: 42= Níquel mate.

\*\* Colores B: 43= Cromado. 44= Dorado. 46= Bronce satinado. 47= Bronce viejo. 50= Níquel negro. 51= Titanio mate.

\* Acabados madera: 01= Nogal. 02= Pino. 03= Teca. 10= Wengué.



# SUGERENCIAS DE MONTAJE

(Con soporte doble 4490\*\*4 y terminal posterior tapón 4422\*\*4)

## COMPONENTES NECESARIOS

REF. Tubo Ø28/ Ø20 (Skin)	Anillas 4598**4 + 4465**4	Soporte 4490**4	Terminales
4482**3/ 4458**3 (1,50 m.)	32 unidades	2 soportes	2+2 terminales
4483**3/ 4459**3 (2,00 m.)	40 unidades	2 soportes	2+2 terminales
4484**3/ 4460**3 (2,50 m.)	52 unidades	3 soportes	2+2 terminales
4485**3/ 4409**3 (3,00 m.)	60 unidades	3 soportes	2+2 terminales

TERMINAL "ESFERA"



<---->	A	B
(1,50 m.)	99,18 €	101,45 €
(2,00 m.)	113,69 €	116,27 €
(2,50 m.)	142,69 €	146,05 €
(3,00 m.)	156,25 €	161,33 €

TERMINAL "COPA"



<---->	A	B
(1,50 m.)	99,18 €	101,45 €
(2,00 m.)	113,69 €	116,27 €
(2,50 m.)	142,69 €	146,05 €
(3,00 m.)	156,25 €	161,33 €

TERMINAL "DAMA"

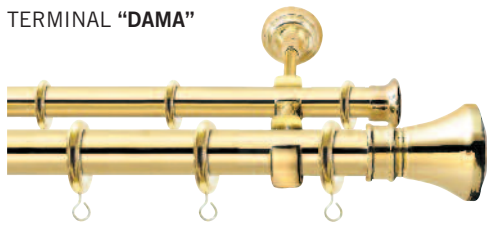

<---->	A	B
(1,50 m.)	99,18 €	101,45 €
(2,00 m.)	113,69 €	116,27 €
(2,50 m.)	142,69 €	146,05 €
(3,00 m.)	156,25 €	161,33 €

TERMINAL "MADRID"



<---->	42	43/ 44/ 47/ 50
(1,50 m.)	104,48 €	106,35 €
(2,00 m.)	118,99 €	121,17 €
(2,50 m.)	147,99 €	150,95 €
(3,00 m.)	161,55 €	166,23 €

TERMINAL "REGENCY"

(No disponible en 46)

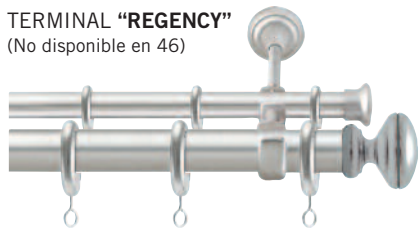

<---->	A	B
(1,50 m.)	95,44 €	97,65 €
(2,00 m.)	109,95 €	112,47 €
(2,50 m.)	138,95 €	142,25 €
(3,00 m.)	152,51 €	157,53 €

TERMINAL "MÓDENA"

(No disponible en 44 y en 46)

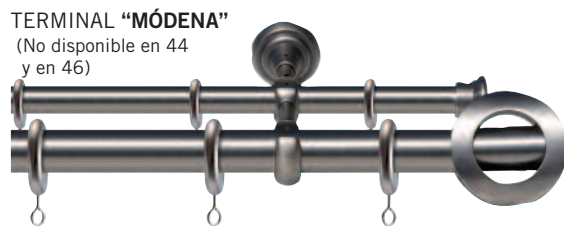

<---->	A	B
(1,50 m.)	96,14 €	98,37 €
(2,00 m.)	110,65 €	113,19 €
(2,50 m.)	139,65 €	142,97 €
(3,00 m.)	153,21 €	158,25 €

TERMINAL "LUGANO"

(No disponible en 44 y 46)

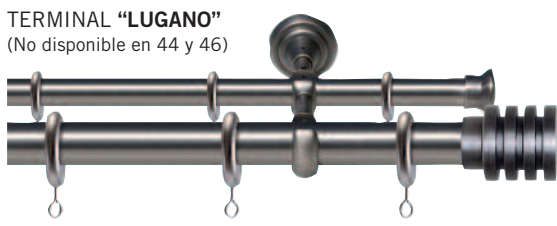

<---->	A	B
(1,50 m.)	95,60 €	98,09 €
(2,00 m.)	110,11 €	112,91 €
(2,50 m.)	137,61 €	141,19 €
(3,00 m.)	152,67 €	157,97 €

TERMINAL "SHANGHAI"

(No disponible en 44 y en 46)

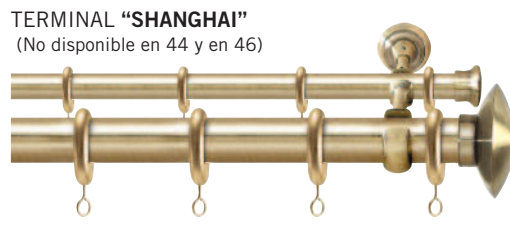

<---->	A	B
(1,50 m.)	95,54 €	98,01 €
(2,00 m.)	110,05 €	112,83 €
(2,50 m.)	137,55 €	141,11 €
(3,00 m.)	152,61 €	157,89 €

\*\* Colores A: 42= Níquel mate.

\*\* Colores B: 43= Cromado. 44= Dorado. 46= Bronce satinado. 47= Bronce viejo. 50= Níquel negro. 51= Titanio mate.

ZIRCONIO Ø28 mm.

# SUGERENCIAS DE MONTAJE

(Con soporte doble 4490\*\*4 y terminal posterior tapón 4422\*\*4)

## COMPONENTES NECESARIOS

REF. Tubo Ø28/ Ø20 (Skin)	Anillas 4598**4 + 4465**4	Soporte 4490**4	Terminales
4482**3/ 4458**3 (1,50 m.)	32 unidades	2 soportes	2+2 terminales
4483**3/ 4459**3 (2,00 m.)	40 unidades	2 soportes	2+2 terminales
4484**3/ 4460**3 (2,50 m.)	52 unidades	3 soportes	2+2 terminales
4485**3/ 4409**3 (3,00 m.)	60 unidades	3 soportes	2+2 terminales

TERMINAL BICOLOR "PRISMA"

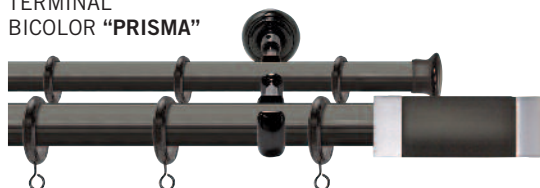

<---->	43-42/ 47/ 50-42
(1,50 m.)	100,95 €
(2,00 m.)	115,77 €
(2,50 m.)	144,05 €
(3,00 m.)	160,83 €

TERMINAL "PINZA"

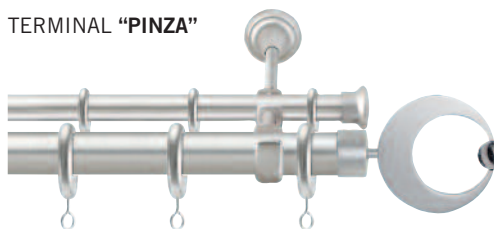

<---->	43-42/ 47/ 50-42
(1,50 m.)	99,71 €
(2,00 m.)	114,53 €
(2,50 m.)	142,81 €
(3,00 m.)	159,59 €

TERMINAL "TAPÓN"

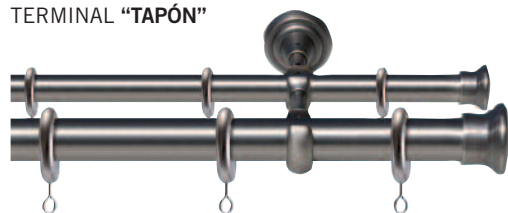

<---->	A	B
(1,50 m.)	84,60 €	86,61 €
(2,00 m.)	99,11 €	101,43 €
(2,50 m.)	126,61 €	129,71 €
(3,00 m.)	141,67 €	146,49 €

TERMINAL "ESPACE"

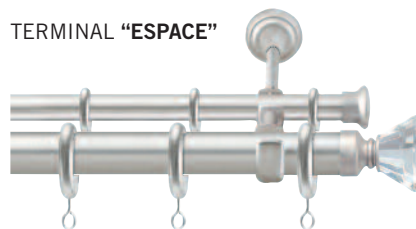

<---->	42	47
(1,50 m.)	103,00 €	104,87 €
(2,00 m.)	117,51 €	119,69 €
(2,50 m.)	145,01 €	147,49 €
(3,00 m.)	160,07 €	164,75 €

TERMINAL "ZAFIRO"



<---->	42	47
(1,50 m.)	107,44 €	109,31 €
(2,00 m.)	121,95 €	124,13 €
(2,50 m.)	149,45 €	152,41 €
(3,00 m.)	164,51 €	169,19 €

TERMINAL "ELIPSE"

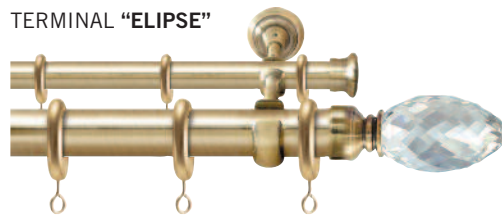

<---->	42	47
(1,50 m.)	97,80 €	99,67 €
(2,00 m.)	112,31 €	114,49 €
(2,50 m.)	139,81 €	142,77 €
(3,00 m.)	154,87 €	159,55 €

TERMINAL "ESFERA"



<---->	42 + madera*	43/ 44/ 46/ 47 + madera*
(1,50 m.)	91,04 €	92,91 €
(2,00 m.)	105,55 €	107,73 €
(2,50 m.)	133,05 €	136,01 €
(3,00 m.)	148,11 €	152,79 €

TERMINAL "CAMPANA"

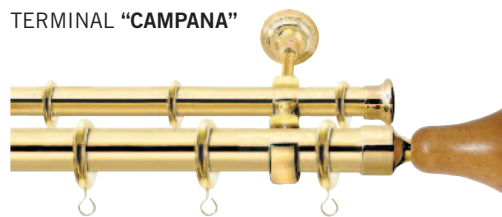

<---->	42 + madera*	43/ 44/ 46/ 47 + madera*
(1,50 m.)	91,22 €	93,09 €
(2,00 m.)	105,73 €	107,91 €
(2,50 m.)	133,23 €	136,19 €
(3,00 m.)	148,29 €	152,97 €

\*\* Colores A: 42= Níquel mate.

\*\* Colores B: 43= Cromado. 44= Dorado. 46= Bronce satinado. 47= Bronce viejo. 50= Níquel negro. 51= Titanio mate.

\* Acabados madera: 01= Nogal. 02= Pino. 03= Teca. 10= Wengué.



# COLORES



06. BLANCO

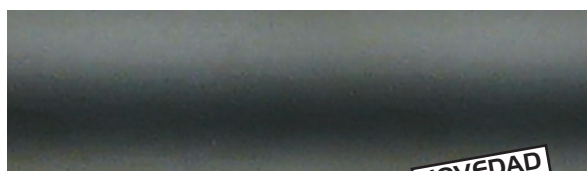

07. NEGRO \*

*Tubo en color negro: Utilizar referencias del tubo de forja en negro (página 57)*



42. NÍQUEL mate



43. CROMADO



44. DORADO



46. BRONCE satinado

HASTA FIN DE EXISTENCIAS



47. BRONCE viejo



50. NÍQUEL negro



51. TITANIO mate

ZIRCONIO Ø20 mm.

## TUBO ZIRCONIO Ø20 mm.



REF.	←----→		BLANCO	NÍQUEL mate	CROMADO	DORADO	BRONCE satinado	BRONCE viejo	NÍQUEL negro	TITANIO mate
4458**3	1,50 m.	x 5	10,73 €/u.	10,53 €/u.	10,73 €/u.	10,73 €/u.	10,73 €/u.	10,73 €/u.	10,73 €/u.	10,73 €/u.
4459**3	2,00 m.	x 5	13,74 €/u.	13,50 €/u.	13,74 €/u.	13,74 €/u.	13,74 €/u.	13,74 €/u.	13,74 €/u.	13,74 €/u.
4460**3	2,50 m.	x 5	16,93 €/u.	16,56 €/u.	16,93 €/u.	16,93 €/u.	16,93 €/u.	16,93 €/u.	16,93 €/u.	16,93 €/u.
4409**3	3,00 m.	x 5	20,54 €/u.	20,15 €/u.	20,54 €/u.	20,54 €/u.	20,54 €/u.	20,54 €/u.	20,54 €/u.	20,54 €/u.

NOTA: Corte de barra 1 € (Referencia 9999989)

\*\* Colores: 06= Blanco. 42= Níquel mate. 43= Cromado. 44= Dorado. 46= Bronce satinado. 47= Bronce viejo. 50= Níquel negro. 51= Titanio mate.  
 \* *Tubo en color negro: Utilizar referencias del tubo de forja en negro (página 57)*  
 Código de envasado: 3= Skin.



# ACCESORIOS

ANILLA PLANA CON SILENCIADOR



Ø IN. 27  
Ø EX. 36

ANILLA CON SILENCIADOR



Ø IN. 29  
Ø EX. 40

ANILLA CON GANCHO METÁLICO  
(No disponible en blanco, negro,  
níquel negro y titanio)



Ø IN. 30  
Ø EX. 39

REF.	4538**2	4538**4	4465**2	4465**4	4464**2	4464**4
	x 10	x 1	x 10	x 1	x 10	x 1
	x 10		x 10		x 10	
A	11,14 €/bl.	1,06 €/u.	7,44 €/bl.	0,68 €/u.	7,42 €/bl.	0,70 €/u.
B	11,64 €/bl.	1,10 €/u.	7,72 €/bl.	0,71 €/u.	7,73 €/bl.	0,72 €/u.

SOPORTE TECHO  
(No disponible en blanco y negro)



Ø49  
50,5  
36

SOPORTE TECHO LARGO



Ø49  
80  
65

SOPORTE TECHO DOBLE 20-20 mm.  
(No disponible en blanco, negro, dorado y bronce satinado)



80  
110  
80  
Ø49  
E/C

REF.	4468**2	4468**4	4083**2	4083**4	4496**2	4496**4
	x 1	x 1	x 1	x 1	x 1	x 1
	x 10		x 10		x 10	
A	8,79 €/bl.	8,25 €/u.	8,67 €/bl.	8,15 €/u.	17,37 €/bl.	16,34 €/u.
B	9,71 €/bl.	9,15 €/u.	9,69 €/bl.	9,11 €/u.	17,62 €/bl.	16,57 €/u.

SOPORTE LATERAL



Ø40  
28

SOPORTE



Ø49  
113  
97

SOPORTE EXTRALARGO 20 mm.  
(solo disponible en níquel mate, bronce viejo,  
níquel negro y titanio)

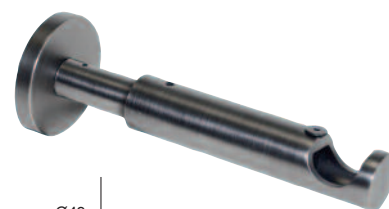

Ø49  
190/230  
170/215

REF.	4539**2	4539**4	4411**2	4411**4	4535**2	4535**4
	x 1 juego	x 1 juego	x 1	x 1	x 1	x 1
	x 10		x 10		x 10	
A	7,46 €/bl.	6,99 €/juego	9,59 €/bl.	9,02 €/u.	12,89 €/bl.	12,13 €/u.
B	7,89 €/bl.	7,40 €/juego	10,25 €/bl.	9,64 €/u.	13,14 €/bl.	12,36 €/u.

NOTA: Envasado en bolsa (.4), el pedido mínimo es de 10 unidades. Anillas en bolsa (.4), el pedido mínimo es de 100 unidades.

\*\* Colores A: 42= Níquel mate.

\*\* Colores B: 06= Blanco. 07= Negro 43= Cromado. 44= Dorado. 46= Bronce satinado. 47= Bronce viejo. 50= Níquel negro. 51= Titanio mate.  
Código de envasado: 2= Blister. 4= Bolsa de protección.



# ACCESORIOS Y TERMINALES MONOCOLOR

SOPORTE EXTENSIBLE

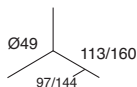

SOPORTE DOBLE 20-20 mm.

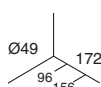
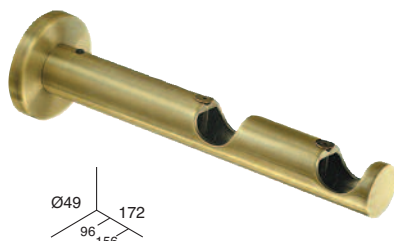

ADAPTADOR PARA SOPORTE DOBLE  
(No disponible en blanco, negro y titanio mate)  
(Para utilizar con soporte doble 4412)

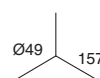
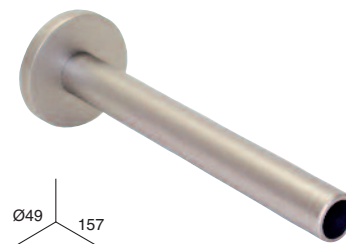

REF.	4466**2	4466**4	4412**2	4412**4	4494**4
	x 1	x 1	x 1	x 1	x 1
	x 10		x 10		
A	10,68 €/bl.	10,02 €/u.	11,82 €/bl.	11,13 €/u.	5,37 €/u.
B	11,89 €/bl.	11,16 €/u.	12,73 €/bl.	11,96 €/u.	5,58 €/u.

REFUERZO PARA SOPORTE  
(No disponible en negro, dorado y bronce satinado)

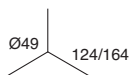
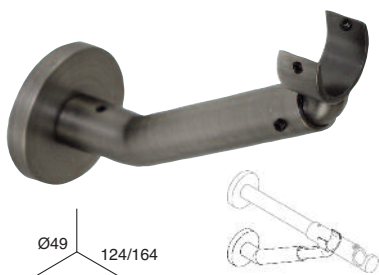

CODO GIRATORIO  
(No disponible en blanco, negro y en níquel negro)

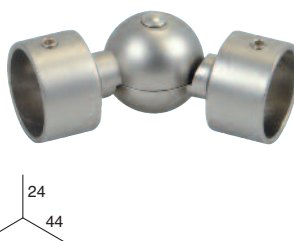

CODO PARA TUBO  
(solo disponible en níquel mate, cromado, bronce viejo y níquel negro)

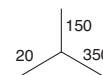

REF.	4497**2	4497**4	4584**2	4584**4	4547**4
	x 1	x 1	x 1	x 1	x 1
	x 10		x 10		
A	12,94 €/bl.	12,15 €/u.	7,38 €/bl.	6,92 €/u.	7,52 €/u.
B	13,31 €/bl.	12,52 €/u.	7,98 €/bl.	7,49 €/u.	7,71 €/u.

EMPALME TUBO. DORADO

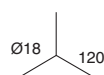

TERMINAL "ESFERA"  
(No disponible en níquel negro)

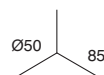

TERMINAL "CÁDIZ"

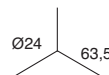

REF.	4032442	4032444	4540**2	4540**4	4414**2	4414**4	
	x 1	x 1	x 2	x 1	x 2	x 1	
	x 10		x 10		x 10		
44	2,84 €/bl.	2,68 €/u.	13,38 €/bl.	6,29 €/u.	12,46 €/bl.	5,89 €/u.	
			A	13,91 €/bl.	6,52 €/u.	13,43 €/bl.	6,33 €/u.

NOTA: Envasado en bolsa (.4), el pedido mínimo es de 10 unidades. Anillas en bolsa (.4), el pedido mínimo es de 100 unidades.

\*\* Colores A: 42= Níquel mate.  
\*\* Colores B: 06= Blanco. 07= Negro 43= Cromado. 44= Dorado. 46= Bronce satinado. 47= Bronce viejo. 50= Níquel negro. 51= Titanio mate.  
Código de envasado: 2= Blister. 4= Bolsa de protección.

ZIRCONIO Ø20 mm.



# TERMINALES MONOCOLOR

TERMINAL "CÓRDOBA"  
(No disponible en blanco, negro, níquel negro y titanio)

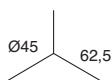

TERMINAL "JEREZ"  
(No disponible en blanco, negro, níquel negro y titanio)

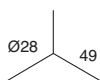

TERMINAL "CÁCERES"  
(No disponible en titanio)

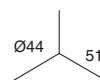

REF.	4593**2	4593**4	4413**2	4413**4	4415**2	4415**4
	x 1 juego	x 1 juego	x 2	x 1	x 2	x 1
	x 10		x 10		x 15	
A	14,78 €/bl.	13,89 €/u.	12,46 €/bl.	5,89 €/u.	12,46 €/bl.	5,89 €/u.
B	15,20 €/bl.	14,31 €/u.	13,43 €/bl.	6,33 €/u.	13,43 €/bl.	6,33 €/u.

TERMINAL "JAÉN"

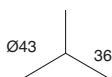

TERMINAL TAPÓN

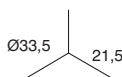

TERMINAL "NEO"  
(No disponible en blanco, negro, dorado, bronce satinado y titanio)

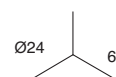
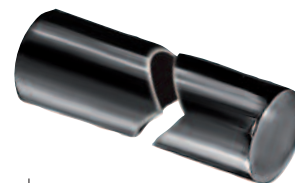

HASTA FIN DE EXISTENCIAS

REF.	4416**2	4416**4	4422**2	4422**4	4806**2	4806**4
	x 2	x 1	x 2	x 1	x 2	x 1
	x 15		x 10		x 10	
A	12,46 €/bl.	5,89 €/u.	7,02 €/bl.	3,29 €/u.	13,48 €/bl.	6,34 €/u.
B	13,43 €/bl.	6,33 €/u.	7,15 €/bl.	3,36 €/u.	13,48 €/bl.	6,34 €/u.

TERMINAL "PALMA"  
(No disponible en blanco, negro, dorado, bronce satinado y titanio)

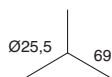

TERMINAL "MADRID"  
(No disponible en blanco, negro, dorado, bronce satinado y titanio)

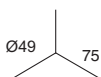

TERMINAL "TOLEDO"  
(No disponible en blanco, negro, dorado, bronce satinado y titanio)

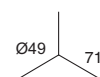

REF.	4803**2	4803**4	4804**2	4804**4	4805**2	4805**4
	x 2	x 1	x 2	x 1	x 2	x 1
	x 10		x 10		x 10	
A	20,43 €/bl.	9,61 €/u.	24,96 €/bl.	11,72 €/u.	21,76 €/bl.	10,24 €/u.
B	20,43 €/bl.	9,61 €/u.	24,96 €/bl.	11,72 €/u.	21,76 €/bl.	10,24 €/u.

NOTA: Envasado en bolsa (.4), el pedido mínimo es de 10 unidades. Anillas en bolsa (.4), el pedido mínimo es de 100 unidades.

\*\* Colores A: 42= Níquel mate.

\*\* Colores B: 06= Blanco. 07= Negro 43= Cromado. 44= Dorado. 46= Bronce satinado. 47= Bronce viejo. 50= Níquel negro. 51= Titanio mate.  
Código de envasado: 2= Blister. 4= Bolsa de protección.





# TERMINALES MONOCOLOR

TERMINAL "MÓDENA"  
(No disponible en bronce satinado)



TERMINAL "REGENCY"  
(No disponible en bronce satinado)



TERMINAL "RONDA"  
(Solo disponible en blanco/cromado)

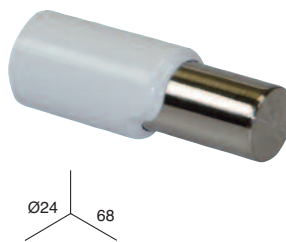

TERMINAL "DÓRICO"  
(No disponible en blanco, negro dorado y bronce satinado)

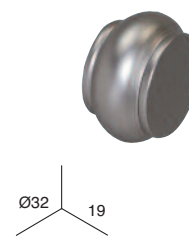

REF.	4834**2	4834**4	4836**2	4836**4	4628432	4628434	4627**2	4627**4
	x 1	x 1	x 2	x 1	x 2	x 1	x 2	x 1
	x 10		x 15		x 10		x 10	
A	8,59 €/bl.	8,05 €/u.	9,00 €/bl.	4,24 €/u.	-	-	7,38 €/bl.	3,47 €/u.
B	8,86 €/bl.	8,30 €/u.	9,17 €/bl.	4,33 €/u.	11,72 €/bl.	5,50 €/u.	7,54 €/bl.	3,55 €/u.

# TERMINALES BICOLOR

TERMINAL "LORCA"

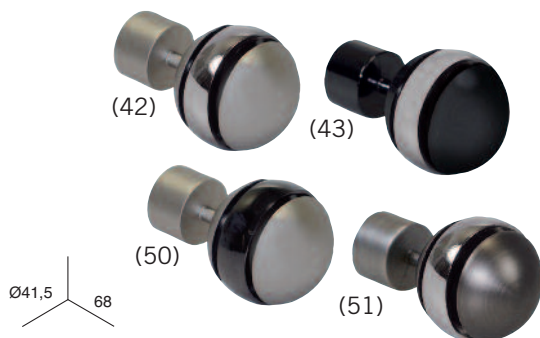

TERMINAL "VALENCIA"

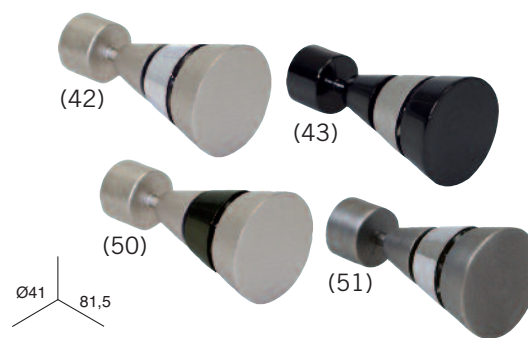

REF.	4827**2	4827**4	4828**2	4828**4
	x 2	x 1	x 2	x 1
	x 15		x 10	
42. Níquel mate/Cromado	22,21 €/bl.	10,43 €/u.	24,15 €/bl.	11,35 €/u.
43. Níquel mate/Níquel negro	22,21 €/bl.	10,43 €/u.	24,15 €/bl.	11,35 €/u.
50. Níquel negro/Níquel mate	22,21 €/bl.	10,43 €/u.	24,15 €/bl.	11,35 €/u.
51. Titanio mate/Cromado	22,21 €/bl.	10,43 €/u.	24,15 €/bl.	11,35 €/u.

TERMINAL "PRISMA"

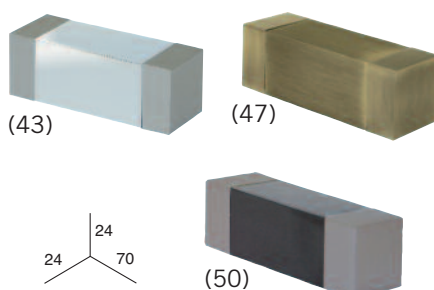

TERMINAL "PINZA"

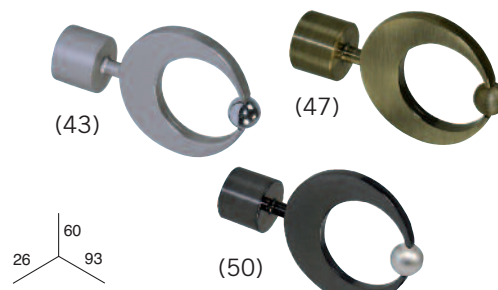

REF.	4832**2	4832**4	4838**2	4838**4
	x 2	x 1	x 1	x 1
	x 10		x 10	
43. Cromado/Níquel mate	16,23 €/bl.	7,65 €/u.	7,57 €/bl.	7,10 €/u.
47. Bronce viejo/Bronce viejo mate	16,23 €/bl.	7,65 €/u.	7,57 €/bl.	7,10 €/u.
50. Níquel negro/Níquel mate	16,23 €/bl.	7,65 €/u.	7,57 €/bl.	7,10 €/u.

NOTA: Envasado en bolsa (.4), el pedido mínimo es de 10 unidades. Anillas en bolsa (.4), el pedido mínimo es de 100 unidades.

\*\* Colores A: 42= Níquel mate.

\*\* Colores B: 06= Blanco. 07= Negro 43= Cromado. 44= Dorado. 46= Bronce satinado. 47= Bronce viejo. 50= Níquel negro. 51= Titanio mate. Código de envasado: 2= Blister. 4= Bolsa de protección.

ZIRCONIO Ø20 mm.



## TERMINALES DE CRISTAL

TERMINAL DE CRISTAL  
"SILICE"

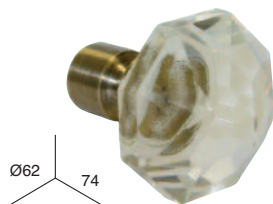

TERMINAL DE CRISTAL  
"ESPACE"

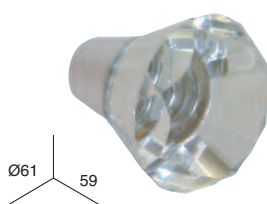

TERMINAL DE CRISTAL  
"ZAFIRO"



TERMINAL DE CRISTAL  
"RUBÍ"

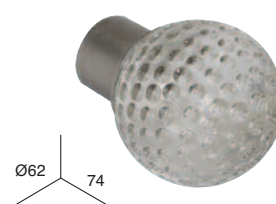

REF.	4726**2	4726**4	4727**2	4727**4	4749**2	4749**4	4748**2	4748**4
	x 1	x 1	x 1	x 1	x 1	x 1	x 1	x 1
	x 10		x 10		x 10		x 10	
42	10,58 €/bl.	9,96 €/u.	10,58 €/bl.	9,96 €/u.	9,20 €/bl.	8,63 €/u.	6,50 €/bl.	6,13 €/u.
47	10,58 €/bl.	9,96 €/u.	10,58 €/bl.	9,96 €/u.	9,20 €/bl.	8,63 €/u.	6,50 €/bl.	6,13 €/u.

## TERMINALES COMBINADOS CON MADERA

TERMINAL "ESFERA"



	REF.			€/blister	REF.		€/unidad
Níquel mate	4418**2	x 2	x 15	9,72 €/bl.	4418**4	x 1	4,56 €/u.
Cromado	4541**2	x 2	x 15	9,95 €/bl.	4541**4	x 1	4,68 €/u.
Dorado	4500**2	x 2	x 15	9,95 €/bl.	4500**4	x 1	4,68 €/u.
Bronce satinado	4542**2	x 2	x 15	9,95 €/bl.	4542**4	x 1	4,68 €/u.
Bronce Viejo	4503**2	x 2	x 15	9,95 €/bl.	4503**4	x 1	4,68 €/u.

TERMINAL "BADAJOZ"



	REF.			€/blister	REF.		€/unidad
Níquel mate	4456**2	x 2	x 10	10,06 €/bl.	4456**4	x 1	4,74 €/u.
Cromado	4543**2	x 2	x 10	10,27 €/bl.	4543**4	x 1	4,82 €/u.
Dorado	4498**2	x 2	x 10	10,27 €/bl.	4498**4	x 1	4,82 €/u.
Bronce satinado	4544**2	x 2	x 10	10,27 €/bl.	4544**4	x 1	4,82 €/u.
Bronce Viejo	4501**2	x 2	x 10	10,27 €/bl.	4501**4	x 1	4,82 €/u.

TERMINAL "MÉRIDA"



	REF.			€/blister	REF.		€/unidad
Níquel mate	4457**2	x 2	x 10	10,06 €/bl.	4457**4	x 1	4,74 €/u.
Cromado	4545**2	x 2	x 10	10,27 €/bl.	4545**4	x 1	4,82 €/u.
Dorado	4499**2	x 2	x 10	10,27 €/bl.	4499**4	x 1	4,82 €/u.
Bronce satinado	4546**2	x 2	x 10	10,27 €/bl.	4546**4	x 1	4,82 €/u.
Bronce Viejo	4502**2	x 2	x 10	10,27 €/bl.	4502**4	x 1	4,82 €/u.

NOTA: Envasado en bolsa (.4), el pedido mínimo es de 10 unidades. Anillas en bolsa (.4), el pedido mínimo es de 100 unidades.

\*\* Colores: 42= Níquel mate. 47= Bronce viejo  
\*\* Colores de la madera : 01= Nogal. 02= Pino. 03= Teca. 10= Wengue.  
Código de envasado: 2= Blister. 4= Bolsa de protección.



# SUGERENCIAS DE MONTAJE

(Con soporte frente 4411\*\*4)

COMPONENTES NECESARIOS			
REF. Tubo Ø20 (Skin)	Anillas 4465**4	Soporte 4411**4	Terminales
4458**3 (1,50 m.)	16 unidades	2 soportes	2 terminales
4459**3 (2,00 m.)	20 unidades	2 soportes	2 terminales
4460**3 (2,50 m.)	26 unidades	3 soportes	2 terminales
4409**3 (3,00 m.)	30 unidades	3 soportes	2 terminales

## TERMINAL "ESFERA"

(No disponible en 50)



<---->	A	B
(1,50 m.)	52,03 €	54,51 €
(2,00 m.)	57,72 €	60,26 €
(2,50 m.)	73,88 €	77,35 €
(3,00 m.)	80,19 €	83,80 €

## TERMINAL "CÁDIZ"



<---->	A	B
(1,50 m.)	51,23 €	54,03 €
(2,00 m.)	56,92 €	59,88 €
(2,50 m.)	73,08 €	76,97 €
(3,00 m.)	79,39 €	83,42 €

## TERMINAL "CÓRDOBA"

(No disponible en 06, 07, 50 y 51)

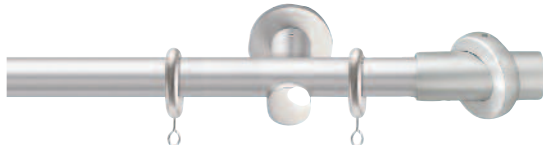

<---->	A	B
(1,50 m.)	53,34 €	55,68 €
(2,00 m.)	59,03 €	61,53 €
(2,50 m.)	75,19 €	78,62 €
(3,00 m.)	81,50 €	85,07 €

## TERMINAL "JEREZ"

(No disponible en 06, 07, 50 y 51)



<---->	A	B
(1,50 m.)	51,23 €	54,03 €
(2,00 m.)	56,92 €	59,88 €
(2,50 m.)	73,08 €	76,97 €
(3,00 m.)	79,39 €	83,42 €

## TERMINAL "CÁCERES"

(No disponible en 51)

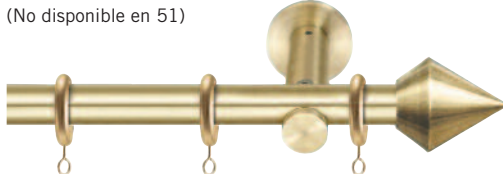

<---->	A	B
(1,50 m.)	51,23 €	54,03 €
(2,00 m.)	56,92 €	59,88 €
(2,50 m.)	73,08 €	76,97 €
(3,00 m.)	79,39 €	83,42 €

## TERMINAL "JAÉN"



<---->	A	B
(1,50 m.)	51,23 €	54,03 €
(2,00 m.)	56,92 €	59,88 €
(2,50 m.)	73,08 €	76,97 €
(3,00 m.)	79,39 €	83,42 €

## TERMINAL "NEO"

(No disponible en 06, 07, 44, 46 y 51)



<---->	42	43/ 47/ 50
(1,50 m.)	52,13 €	54,05 €
(2,00 m.)	57,81 €	59,90 €
(2,50 m.)	73,98 €	76,99 €
(3,00 m.)	80,29 €	83,44 €

## TERMINAL "REGENCY"

(No disponible en 46)



<---->	A	B
(1,50 m.)	47,93 €	50,03 €
(2,00 m.)	53,62 €	55,88 €
(2,50 m.)	69,78 €	72,97 €
(3,00 m.)	76,09 €	79,42 €

\*\* Colores A: 42= Níquel mate.

\*\* Colores B: 06= Blanco. 07= Negro 43= Cromado. 44= Dorado. 46= Bronce satinado. 47= Bronce viejo. 50= Níquel negro. 51= Titanio mate.

# SUGERENCIAS DE MONTAJE

(Con soporte frente 4411\*\*4)

## COMPONENTES NECESARIOS

REF. Tubo Ø20 (Skin)	Anillas 4465**4	Soporte 4411**4	Terminales
4458**3 (1,50 m.)	16 unidades	2 soportes	2 terminales
4459**3 (2,00 m.)	20 unidades	2 soportes	2 terminales
4460**3 (2,50 m.)	26 unidades	3 soportes	2 terminales
4409**3 (3,00 m.)	30 unidades	3 soportes	2 terminales

### TERMINAL "RONDA"



<---->	43
(1,50 m.)	52,37 €
(2,00 m.)	58,22 €
(2,50 m.)	75,31 €
(3,00 m.)	81,76 €

### TERMINAL "DÓRICO"

(No disponible en 06, 07, 44 y 46)



<---->	A	B
(1,50 m.)	46,39 €	48,47 €
(2,00 m.)	52,08 €	54,32 €
(2,50 m.)	68,24 €	71,41 €
(3,00 m.)	75,55 €	77,86 €

### TERMINAL "MÓDENA"

(No disponible en 46)

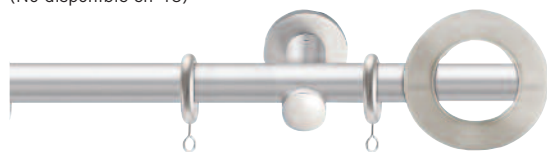

<---->	A	B
(1,50 m.)	55,55 €	57,97 €
(2,00 m.)	61,24 €	63,82 €
(2,50 m.)	77,40 €	80,91 €
(3,00 m.)	83,71 €	87,36 €

### TERMINAL "PALMA"

(No disponible en 06, 07, 44, 46 y 51)



<---->	42	43/ 47/ 50
(1,50 m.)	58,67 €	60,59 €
(2,00 m.)	64,36 €	66,44 €
(2,50 m.)	80,52 €	83,53 €
(3,00 m.)	86,83 €	89,98 €

### TERMINAL "MADRID"

(No disponible en 06, 07, 44, 46 y 51)

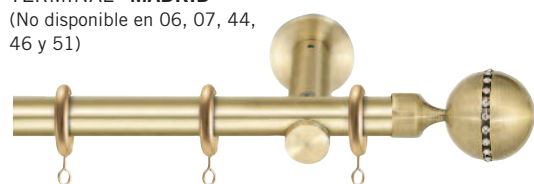

<---->	42	43/ 47/ 50
(1,50 m.)	62,89 €	64,81 €
(2,00 m.)	68,58 €	70,66 €
(2,50 m.)	84,74 €	87,75 €
(3,00 m.)	91,05 €	94,20 €

### TERMINAL "TOLEDO"

(No disponible en 06, 07, 44, 46 y 51)

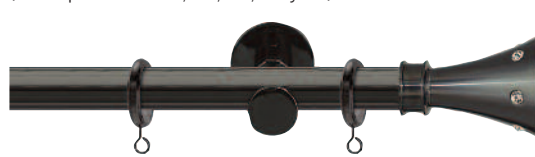

<---->	42	43/ 47/ 50
(1,50 m.)	59,93 €	61,85 €
(2,00 m.)	65,62 €	67,70 €
(2,50 m.)	81,78 €	84,79 €
(3,00 m.)	88,09 €	91,24 €

### TERMINAL BICOLOR "LORCA"

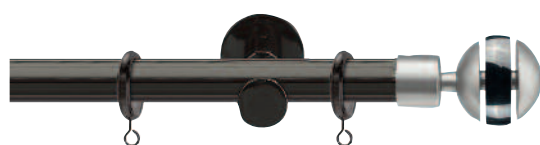

<---->	42 / 43 / 50 / 51
(1,50 m.)	62,23 €
(2,00 m.)	68,08 €
(2,50 m.)	85,17 €
(3,00 m.)	91,62 €

### TERMINAL BICOLOR "VALENCIA"



<---->	42 / 43 / 50 / 51
(1,50 m.)	64,07 €
(2,00 m.)	69,92 €
(2,50 m.)	87,01 €
(3,00 m.)	93,46 €

\*\* Colores A: 42= Níquel mate.

\*\* Colores B: 06= Blanco. 07= Negro 43= Cromado. 44= Dorado. 46= Bronce satinado. 47= Bronce viejo. 50= Níquel negro. 51= Titanio mate.

# SUGERENCIAS DE MONTAJE

(Con soporte frente 4411\*\*4)

COMPONENTES NECESARIOS			
REF. Tubo Ø20 (Skin)	Anillas 4465**4	Soporte 4411**4	Terminales
4458**3 (1,50 m.)	16 unidades	2 soportes	2 terminales
4459**3 (2,00 m.)	20 unidades	2 soportes	2 terminales
4460**3 (2,50 m.)	26 unidades	3 soportes	2 terminales
4409**3 (3,00 m.)	30 unidades	3 soportes	2 terminales

TERMINAL BICOLOR "PRISMA"

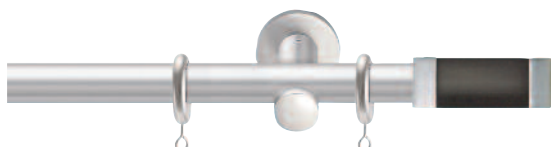

<---->	43-42/ 47/ 50-42
(1,50 m.)	56,67 €
(2,00 m.)	62,52 €
(2,50 m.)	79,61 €
(3,00 m.)	86,06 €

TERMINAL BICOLOR "PINZA"

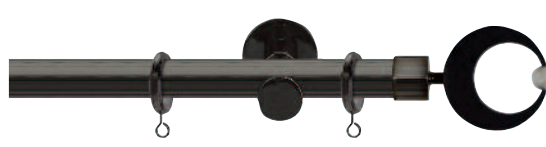

<---->	43-42/ 47/ 50-42
(1,50 m.)	55,57 €
(2,00 m.)	61,42 €
(2,50 m.)	78,51 €
(3,00 m.)	84,96 €

TERMINAL DE CRISTAL "SILICE"

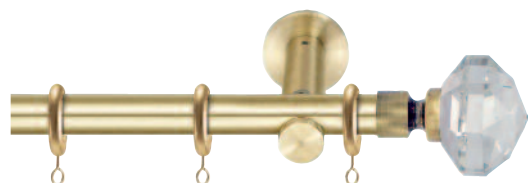

<---->	42	47
(1,50 m.)	59,37 €	61,29 €
(2,00 m.)	65,06 €	67,14 €
(2,50 m.)	81,22 €	84,23 €
(3,00 m.)	87,53 €	90,68 €

TERMINAL DE CRISTAL "ESPACE"



<---->	42	47
(1,50 m.)	59,37 €	61,29 €
(2,00 m.)	65,06 €	67,14 €
(2,50 m.)	81,22 €	84,23 €
(3,00 m.)	87,53 €	90,68 €

TERMINAL DE CRISTAL "ZAFIRO"



<---->	42	47
(1,50 m.)	56,71 €	58,63 €
(2,00 m.)	62,40 €	64,48 €
(2,50 m.)	78,56 €	81,57 €
(3,00 m.)	84,87 €	88,02 €

TERMINAL DE MADERA "ESFERA"



<---->	42+Madera*	43/ 44/ 46/ 47 + madera*
(1,50 m.)	48,57 €	50,49 €
(2,00 m.)	54,26 €	56,34 €
(2,50 m.)	70,42 €	73,43 €
(3,00 m.)	76,73 €	79,88 €

TERMINAL DE MADERA "BADAJOZ"



<---->	42+Madera*	43/ 44/ 46/ 47 + madera*
(1,50 m.)	48,93 €	50,85 €
(2,00 m.)	54,62 €	56,70 €
(2,50 m.)	70,78 €	73,79 €
(3,00 m.)	77,09 €	80,24 €

TERMINAL DE MADERA "MÉRIDA"



<---->	42+Madera*	43/ 44/ 46/ 47 + madera*
(1,50 m.)	48,93 €	50,85 €
(2,00 m.)	54,62 €	56,70 €
(2,50 m.)	70,78 €	73,79 €
(3,00 m.)	77,09 €	80,24 €

\*\* Colores: 42= Níquel mate. 43= Cromado. 44= Dorado. 46= Bronce satinado. 47= Bronce viejo.  
\* Acabados madera: 01= Nogal. 02= Pino. 03= Teca. 10= Wengué.

# SUGERENCIAS DE MONTAJE

## Riel doble Ø20-20 mm.

(Con soporte doble 4412\*\*4 y terminal posterior tapón 4422\*\*4)

### COMPONENTES NECESARIOS

REF. Tubo Ø20 (Skin)	Anillas 4465**4	Soporte 4412**4	Terminales
4458**3 x 2 (1,50 m.)	32 unidades	2 soportes	2+2 terminales
4459**3 x 2 (2,00 m.)	40 unidades	2 soportes	2+2 terminales
4460**3 x 2 (2,50 m.)	52 unidades	3 soportes	2+2 terminales
4409**3 x 2 (3,00 m.)	60 unidades	3 soportes	2+2 terminales

#### TERMINAL "ESFERA"

(No disponible en 50)



<---->	A	B
(1,50 m.)	84,24 €	87,86 €
(2,00 m.)	95,62 €	99,56 €
(2,50 m.)	121,03 €	126,42 €
(3,00 m.)	133,65 €	139,32 €

#### TERMINAL "CÁDIZ"

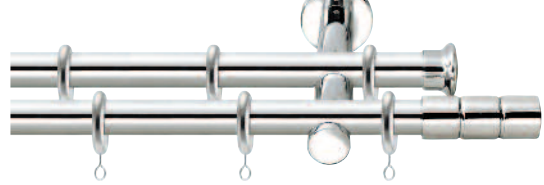

<---->	A	B
(1,50 m.)	83,44 €	87,48 €
(2,00 m.)	94,82 €	99,18 €
(2,50 m.)	120,23 €	126,04 €
(3,00 m.)	132,85 €	138,94 €

#### TERMINAL "CÓRDOBA"

(No disponible en 06, 07, 50 y 51)

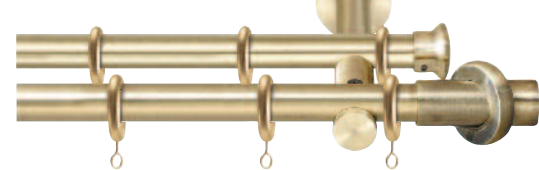

<---->	A	B
(1,50 m.)	85,55 €	89,13 €
(2,00 m.)	96,93 €	100,83 €
(2,50 m.)	122,34 €	127,69 €
(3,00 m.)	134,96 €	140,59 €

#### TERMINAL "JEREZ"

(No disponible en 06, 07, 50 y 51)



<---->	A	43/ 47/ 50
(1,50 m.)	83,44 €	87,48 €
(2,00 m.)	94,82 €	99,18 €
(2,50 m.)	120,23 €	126,04 €
(3,00 m.)	132,85 €	138,94 €

#### TERMINAL "CÁCERES"

(No disponible en 51)



<---->	A	B
(1,50 m.)	83,44 €	87,48 €
(2,00 m.)	94,82 €	99,18 €
(2,50 m.)	120,23 €	126,04 €
(3,00 m.)	132,85 €	138,94 €

#### TERMINAL "JAÉN"



<---->	A	B
(1,50 m.)	83,44 €	87,48 €
(2,00 m.)	94,82 €	99,18 €
(2,50 m.)	120,23 €	126,04 €
(3,00 m.)	132,85 €	138,94 €

#### TERMINAL "NEO" (No disponible en 06, 07, 44, 46 y 51)

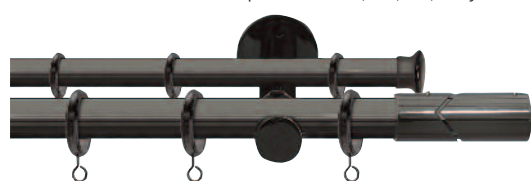

<---->	42	43/ 47/ 50
(1,50 m.)	84,34 €	87,50 €
(2,00 m.)	95,72 €	99,20 €
(2,50 m.)	121,13 €	126,06 €
(3,00 m.)	133,75 €	138,96 €

#### TERMINAL "REGENCY"

(No disponible en 46)

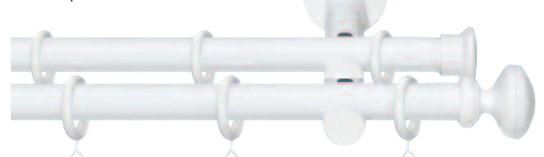

<---->	A	B
(1,50 m.)	80,14 €	83,48 €
(2,00 m.)	91,52 €	95,18 €
(2,50 m.)	116,93 €	122,04 €
(3,00 m.)	129,55 €	134,94 €

\*\* Colores A: 42= Níquel mate.

\*\* Colores B: 06= Blanco. 07= Negro 43= Cromado. 44= Dorado. 46= Bronce satinado. 47= Bronce viejo. 50= Níquel negro. 51= Titanio mate.



# SUGERENCIAS DE MONTAJE

## Riel doble Ø20-20 mm.

(Con soporte doble 4412\*\*4 y terminal posterior tapón 4422\*\*4)

### COMPONENTES NECESARIOS

REF. Tubo Ø20 (Skin)	Anillas 4465**4	Soporte 4412**4	Terminales
4458**3 x 2 (1,50 m.)	32 unidades	2 soportes	2+2 terminales
4459**3 x 2 (2,00 m.)	40 unidades	2 soportes	2+2 terminales
4460**3 x 2 (2,50 m.)	52 unidades	3 soportes	2+2 terminales
4409**3 x 2 (3,00 m.)	60 unidades	3 soportes	2+2 terminales

#### TERMINAL "RONDA"



<---->	43
(1,50 m.)	85,82 €
(2,00 m.)	97,52 €
(2,50 m.)	124,38 €
(3,00 m.)	137,28 €

#### TERMINAL "DÓRICO"

(No disponible en 06, 07, 44 y 46)



<---->	A	B
(1,50 m.)	78,60 €	81,92 €
(2,00 m.)	89,98 €	93,62 €
(2,50 m.)	115,39 €	120,48 €
(3,00 m.)	128,01 €	133,38 €

#### TERMINAL "MÓDENA"

(No disponible en 46)

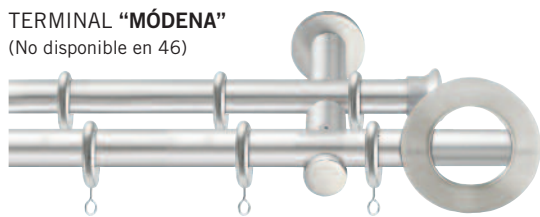

<---->	A	B
(1,50 m.)	87,76 €	91,42 €
(2,00 m.)	99,14 €	103,12 €
(2,50 m.)	124,55 €	129,98 €
(3,00 m.)	137,17 €	142,88 €

#### TERMINAL "PALMA"

(No disponible en 06, 07, 44, 46 y 51)

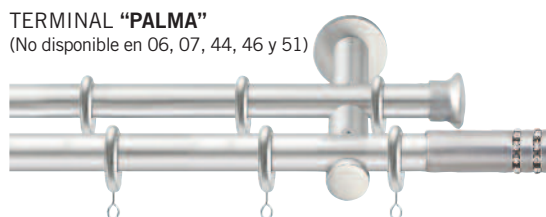

<---->	42	43/ 47/ 50
(1,50 m.)	90,88 €	94,04 €
(2,00 m.)	102,26 €	105,74 €
(2,50 m.)	127,67 €	132,60 €
(3,00 m.)	140,29 €	145,50 €

#### TERMINAL "MADRID"

(No disponible en 06, 07, 44, 46 y 51)



<---->	42	43/ 47/ 50
(1,50 m.)	95,10 €	98,26 €
(2,00 m.)	106,48 €	109,96 €
(2,50 m.)	131,89 €	136,82 €
(3,00 m.)	144,51 €	149,72 €

#### TERMINAL "TOLEDO"

(No disponible en 06, 07, 44, 46 y 51)

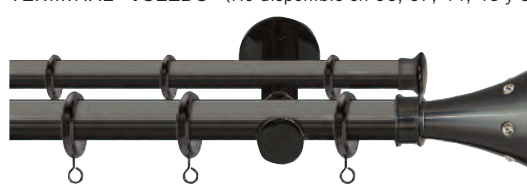

<---->	42	43/ 47/ 50
(1,50 m.)	92,14 €	95,30 €
(2,00 m.)	103,52 €	107,00 €
(2,50 m.)	128,93 €	133,86 €
(3,00 m.)	141,55 €	146,76 €

#### TERMINAL BICOLOR "LORCA"

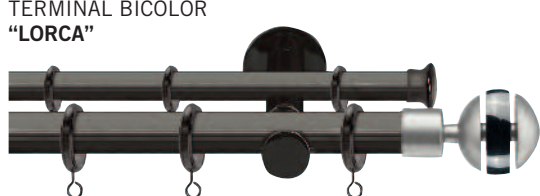

<---->	42-43/ 50-42 / 51-43
(1,50 m.)	95,68 €
(2,00 m.)	107,38 €
(2,50 m.)	134,24 €
(3,00 m.)	147,14 €

#### TERMINAL BICOLOR "VALENCIA"

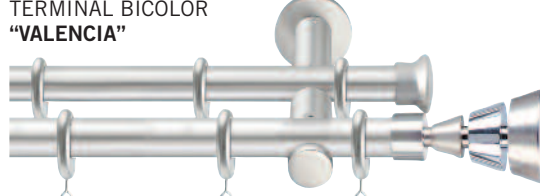

<---->	42-43/ 50-42 / 51-43
(1,50 m.)	97,52 €
(2,00 m.)	109,22 €
(2,50 m.)	136,08 €
(3,00 m.)	148,98 €

\*\* Colores A: 42= Níquel mate.

\*\* Colores B: 06= Blanco. 07= Negro 43= Cromado. 44= Dorado. 46= Bronce satinado. 47= Bronce viejo. 50= Níquel negro. 51= Titanio mate.

# SUGERENCIAS DE MONTAJE

## Riel doble Ø20-20 mm.

(Con soporte doble 4412\*\*4 y terminal posterior tapón 4422\*\*4)

### COMPONENTES NECESARIOS

REF. Tubo Ø20 (Skin)	Anillas 4465**4	Soporte 4412**4	Terminales
4458**3 x 2 (1,50 m.)	32 unidades	2 soportes	2+2 terminales
4459**3 x 2 (2,00 m.)	40 unidades	2 soportes	2+2 terminales
4460**3 x 2 (2,50 m.)	52 unidades	3 soportes	2+2 terminales
4409**3 x 2 (3,00 m.)	60 unidades	3 soportes	2+2 terminales

TERMINAL BICOLOR "PRISMA"



<---->	43-42/ 47/ 50-42
(1,50 m.)	90,12 €
(2,00 m.)	101,82 €
(2,50 m.)	128,68 €
(3,00 m.)	141,58 €

TERMINAL BICOLOR "PINZA"

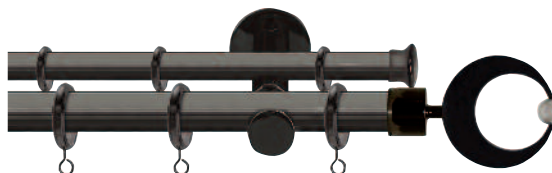

<---->	43-42/ 47/ 50-42
(1,50 m.)	89,02 €
(2,00 m.)	100,72 €
(2,50 m.)	127,58 €
(3,00 m.)	140,48 €

TERMINAL DE CRISTAL "SILICE"

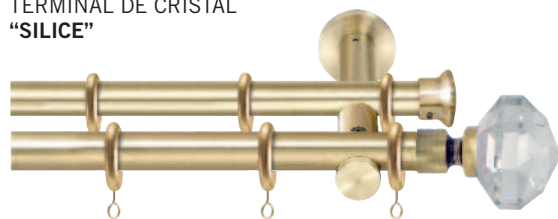

<---->	42	47
(1,50 m.)	91,58 €	94,74 €
(2,00 m.)	102,96 €	106,44 €
(2,50 m.)	128,37 €	133,30 €
(3,00 m.)	140,99 €	146,20 €

TERMINAL DE CRISTAL "ESPACE"

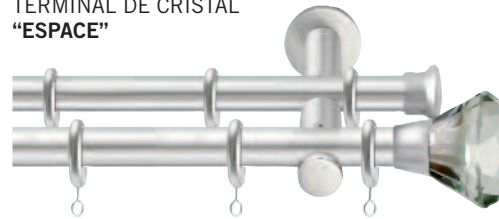

<---->	42	47
(1,50 m.)	91,58 €	94,74 €
(2,00 m.)	102,96 €	106,44 €
(2,50 m.)	128,37 €	133,30 €
(3,00 m.)	140,99 €	146,20 €

TERMINAL DE CRISTAL "ZAFIRO"



<---->	42	47
(1,50 m.)	88,92 €	92,08 €
(2,00 m.)	100,30 €	103,78 €
(2,50 m.)	125,71 €	130,64 €
(3,00 m.)	138,33 €	143,54 €

TERMINAL DE MADERA "ESFERA"



<---->	42+Madera*	43/ 44/ 46/ 47 + madera*
(1,50 m.)	80,78 €	83,94 €
(2,00 m.)	92,16 €	95,64 €
(2,50 m.)	117,57 €	122,50 €
(3,00 m.)	130,19 €	135,40 €

TERMINAL DE MADERA "BADAJOZ"



<---->	42+Madera*	43/ 44/ 46/ 47 + madera*
(1,50 m.)	81,14 €	84,30 €
(2,00 m.)	92,52 €	96,00 €
(2,50 m.)	117,93 €	122,86 €
(3,00 m.)	130,55 €	135,76 €

TERMINAL DE MADERA "MÉRIDA"

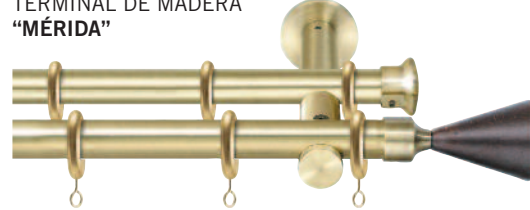

<---->	42+Madera*	43/ 44/ 46/ 47 + madera*
(1,50 m.)	81,14 €	84,30 €
(2,00 m.)	92,52 €	96,00 €
(2,50 m.)	117,93 €	122,86 €
(3,00 m.)	130,55 €	135,76 €

\*\* Colores: 42= Níquel mate. 43= Cromado. 44= Dorado. 46= Bronce satinado. 47= Bronce viejo.

\* Acabados madera: 01= Nogal. 02= Pino. 03= Teca. 10= Wengué.



**NOVEDAD**



# TUBO Ø20 mm. ABIERTO Y ACCESORIOS

(TODOS LOS ACCESORIOS DEL TUBO DE ZIRCONIO DE 20 mm. SON COMPATIBLES CON ESTE TUBO)

TUBO ABIERTO Ø20 mm.



REF.	<---->		NÍQUEL mate	TITANIO mate
4227**3	1,50 m.	x 5	14,50 €/u.	14,50 €/u.
4228**3	2,00 m.	x 5	18,36 €/u.	18,36 €/u.
4229**3	2,40 m.	x 5	22,90 €/u.	22,90 €/u.

PERFIL PORTATELA (PARA PANEL JAPONÉS)

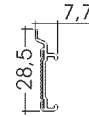

REF.	<---->		BLANCO	PLATA
0928**0	6,00 m.	x 20	32,12 €/u.	35,08 €/u.
0940**0	4,00 m.	x 20	26,48 €/u.	29,40 €/u.

(Para utilizar con corredera 7571\*\*0)

TAPÓN PARA TUBO



EMPALME PARA TUBO ABIERTO



CORREDERA PARA PANEL JAPONÉS

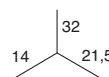
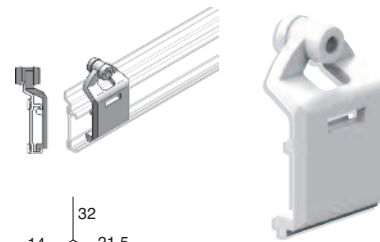

REF.	4285**2	4286442	7571**0	
	x 2		x 1	
	x 10		x 10	
	42	3,91 €/bl.		06
	51	(Solo color 44)		32
	4,88 €/bl.			0,29 €/u.
	5,36 €/bl.			0,32 €/u.

CORREDERA CON RUEDA (ESTRECHA)  
(Ristra de 10 unidades)

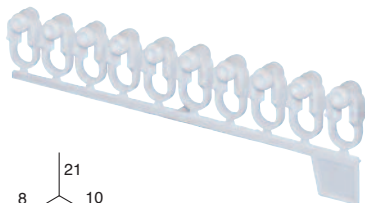

CORREDERA CON HILO "CHYC"

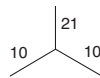

REF.	PASO 80			PASO 60					
	0609**0	0609**2	0232060	0348060	0349060	0270060	0346060	0347060	
	x 400		x 20	Rollo x 100 m.	2 m.	5 m.	Rollo x 100 m.	2 m.	5 m.
	06	48,30 €/Caja	3,59 €/bl.	1,64 €/m.	3,33 €/m.	8,36 €/u.	1,89 €/m.	3,83 €/u.	9,59 €/u.
	32	48,30 €/Caja	3,59 €/bl.	-	-	-	-	-	-

Colores: 06= Blanco. 32= Gris. 40= Plata. 42= Níquel mate. 51= Titanio mate.  
Código de envasado: 2= Blister. 3= Skin.

ZIRCONIO Ø20 mm.

# TUBO Ø20 mm. ABIERTO

(TODOS LOS ACCESORIOS DEL TUBO DE ZIRCONIO DE 20 mm. SON COMPATIBLES CON ESTE TUBO)

SOPORTE TECHO



34  
Ø16

SOPORTE MÚLTIPLE (x4)

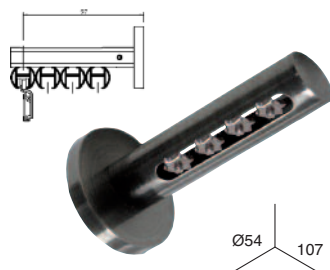

Ø54 107

SOPORTE AUTOMÁTICO



Ø49 110  
95

REF.	4266**2	4267**2	4289**2
	x 1	x 1	x 1
	x 10	x 10	x 10
42	5,81 €/bl.	10,90 €/bl.	10,26 €/bl.
50	-	-	10,99 €/bl.
51	6,05 €/bl.	11,28 €/bl.	10,99 €/bl.

SOPORTE AUTOMÁTICO DOBLE

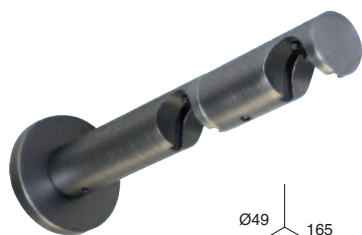

Ø49 165  
90 150

SOPORTE AUTOMÁTICO EXTENSIBLE



Ø49 110/150  
95/135

SOPORTE AUTOMÁTICO TECHO DOBLE



80  
110 80  
Ø49 E/C

REF.	4287**2	4288**2	4496**2
	x 1	x 1	x 1
	x 10	x 10	x 10
42	12,61 €/bl.	11,33 €/bl.	17,37 €/bl.
50	13,50 €/bl.	12,57 €/bl.	17,62 €/bl.
51	13,50 €/bl.	12,57 €/bl.	17,62 €/bl.

**SOPORTES AUTOMÁTICOS:** Se trata de una gama de soporte central, extensible, doble y doble techo con un sistema dual de fijación; por un lado un clip de fijación para el tubo de zirconio estándar, y por otro, tornillo y tuerca estriada para su uso con el nuevo perfil del riel de zirconio de Ø20 mm.

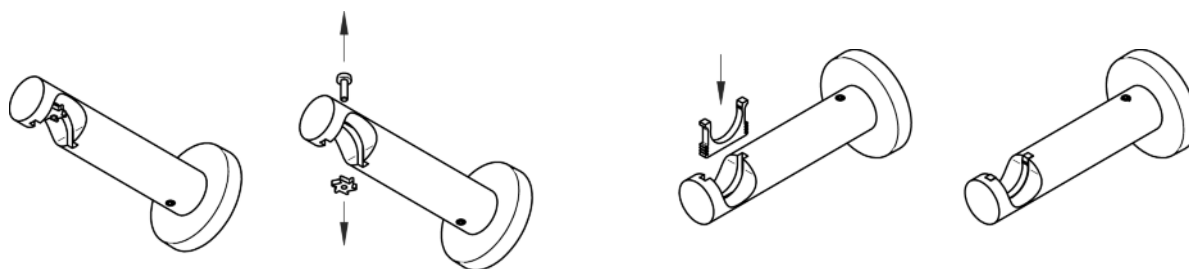

\*\* Colores: 42= Níquel mate. 50= Níquel negro. 51= Titanio mate. (Color 50 solo para soportes automáticos)  
Código de envasado: 2= Blister.

## SUGERENCIAS DE MONTAJE

Con soporte automático 4289\*\*2, terminal tapón 4285\*\*2 y corredera con rueda 0609\*\*0

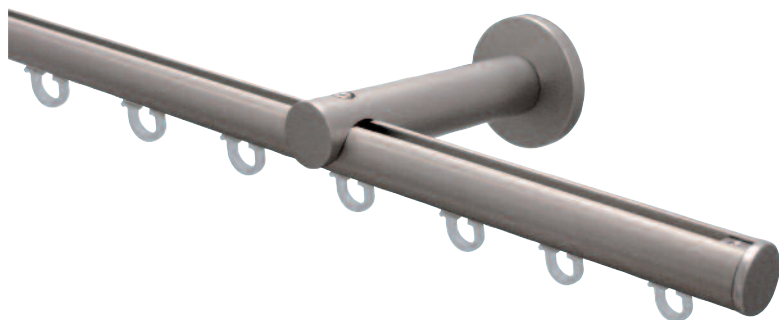

COMPONENTES (CON SOPORTE SENCILLO 4289)				
Referencia tubo Ø20 (Skin)	<----->	Corredera con rueda 0609	Soportes 4289	Terminal 4285
4227**3	1,50 m.	16	2	2
4228**3	2,00 m.	20	2	2
4229**3	2,40 m.	24	3	2

## SUGERENCIAS DE MONTAJE

Con soporte automático 4289\*\*2, terminal tapón 4285\*\*2 y corredera con hilo (Paso 60 ó 80)

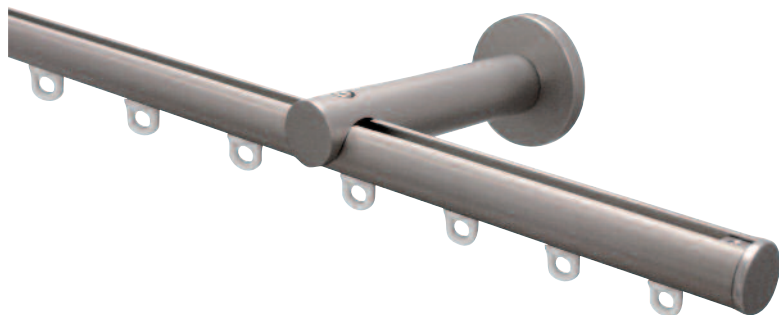

COMPONENTES (CON SOPORTE SENCILLO Y CORREDERA CON HILO PASO 60)				
Referencia tubo Ø20 (Skin)	<----->	Corredera con hilo 0270	Soportes 4289	Terminal 4285
4227**3	1,50 m.	1,80 m.	2	2
4228**3	2,00 m.	2,30 m.	2	2
4229**3	2,40 m.	2,70 m.	3	2

COMPONENTES (CON SOPORTE SENCILLO Y CORREDERA CON HILO PASO 80)				
Referencia tubo Ø20 (Skin)	<----->	Corredera con hilo 0232	Soportes 4289	Terminal 4285
4227**3	1,50 m.	1,80 m.	2	2
4228**3	2,00 m.	2,30 m.	2	2
4229**3	2,40 m.	2,70 m.	3	2

\*\* Colores: 42= Níquel mate. 51= Titanio mate

## SUGERENCIAS DE MONTAJE PANEL JAPONÉS

Con soporte múltiple 4267, terminal tapón 4285 y corredera para panel japonés 7571 y perfil portatela 0940

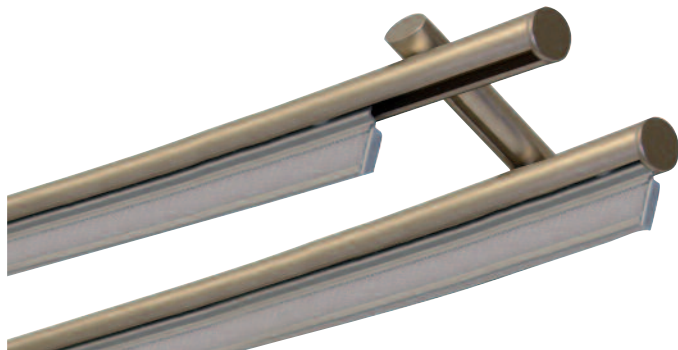

### 2 VÍAS

COMPONENTES (CON SOPORTE MÚLTIPLE Y 2 TUBOS)					
Referencia tubo Ø20 (Skin)	<---->	Corredera 7571	Soportes 4267	Perfil portatela 0940	Terminal 4285
4227**3 x 2	1,50 m.	6 x m.	2	2	2+2
4228**3 x 2	2,00 m.	6 x m.	3	2	2+2
4229**3 x 2	2,40 m.	6 x m.	3	2	2+2

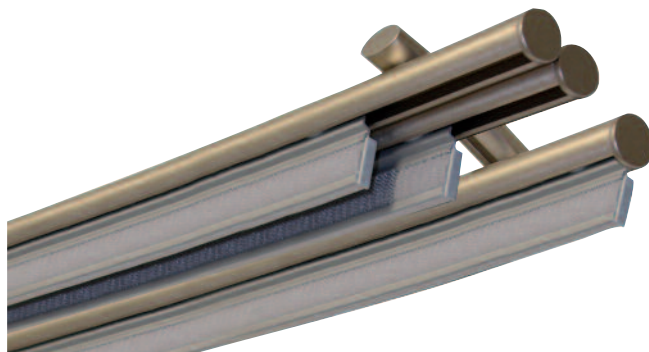

### 3 VÍAS

COMPONENTES (CON SOPORTE MÚLTIPLE Y 2 TUBOS)					
Referencia tubo Ø20 (Skin)	<---->	Corredera 7571	Soportes 4267	Perfil portatela 0940	Terminal 4285
4227**3 x 3	1,50 m.	6 x m.	2	3	2+2+2
4228**3 x 3	2,00 m.	6 x m.	3	3	2+2+2
4229**3 x 3	2,40 m.	6 x m.	3	3	2+2+2

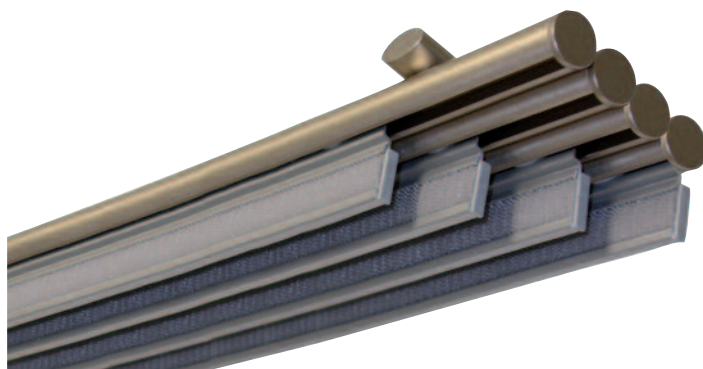

### 4 VÍAS

COMPONENTES (CON SOPORTE MÚLTIPLE Y 2 TUBOS)					
Referencia tubo Ø20 (Skin)	<---->	Corredera 7571	Soportes 4267	Perfil portatela 0940	Terminal 4285
4227**3 x 4	1,50 m.	6 x m.	2	4	2+2+2+2
4228**3 x 4	2,00 m.	6 x m.	3	4	2+2+2+2
4229**3 x 4	2,40 m.	6 x m.	3	4	2+2+2+2

\*\* Colores: 42= Níquel mate. 51= Titanio mate



**NOVEDAD**

# ZIRCONIO Ø12 mm.

TUBO ZIRCONIO Ø12 mm.

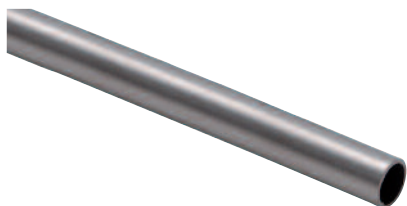

ANILLA PLANA CON SILENCIADOR



Ø IN. 18  
Ø EX. 25

EMPALME PARA TUBO



9,5  
9,5  
100

REF.	4117**3	4118**3	4119**3	4644**2	4643402
	1,20 m.	1,60 m.	2,00 m.	☐ x 10	☐ x 1
	—	—	—	☐ x 10	☐ x 10
A	5,38 €/sk.	7,18 €/sk.	8,86 €/sk.	10,29 €/bl.	2,74 €/bl.
B	5,38 €/sk.	7,18 €/sk.	8,86 €/sk.	10,29 €/bl.	-

SOPORTE CENTRAL

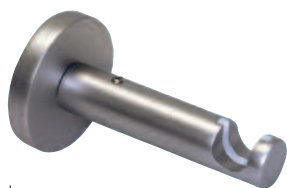

Ø45  
80,5  
70

SOPORTE TECHO



29  
Ø16

SOPORTE LATERAL



Ø16,5  
22

REF.	4637**2	4638**2	4639**2
	☐ x 1	☐ x 1	☐ x 1
	☐ x 10	☐ x 10	☐ x 10
A	6,76 €/bl.	4,12 €/bl.	4,75 €/bl.
B	6,76 €/bl.	4,12 €/bl.	4,75 €/bl.

TERMINAL CÁDIZ



Ø13  
33

TERMINAL ESFERA



Ø25  
22

TERMINAL TAPÓN



Ø16  
15

REF.	4640**2	4641**2	4642**2
	☐ x 2	☐ x 2	☐ x 2
	☐ x 10	☐ x 10	☐ x 10
A	6,34 €/bl.	6,48 €/bl.	5,47 €/bl.
B	6,34 €/bl.	6,48 €/bl.	5,47 €/bl.

\*\* Colores A: 42= Níquel mate.

\*\* Colores B: 06= Blanco. 07= Negro. 43= Cromado. 51= Titanio mate.

Código de envasado: 2= Blister. 3= Skin.

ZIRCONIO 12 mm.



# ACCESORIOS COMUNES

GANCHO LISO  
(No disponible en blanco)

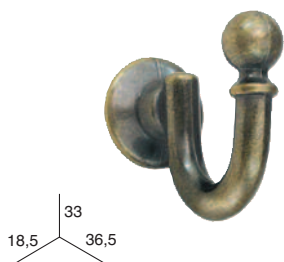

ALZAPAJOS "DIAMANTE" 50 MM.  
(No disponible en blanco)



ALZAPAJOS "DIAMANTE" 78 MM.  
(No disponible en blanco)

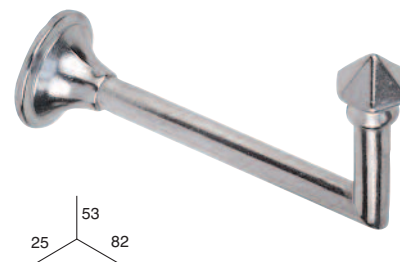

REF.	4572**2	4572**4	4595**2	4595**4	4596**2	4596**4
	x 2	x 1	x 2	x 1	x 2	x 1
	x 10		x 10		x 10	
A	5,85 €/bl.	2,75 €/u.	6,42 €/bl.	3,04 €/u.	7,09 €/bl.	3,34 €/u.
B	5,98 €/bl.	2,83 €/u.	6,62 €/bl.	3,12 €/u.	7,30 €/bl.	3,44 €/u.

RECOGE-CORTINAS PLANO  
(No disponible en blanco y níquel negro)

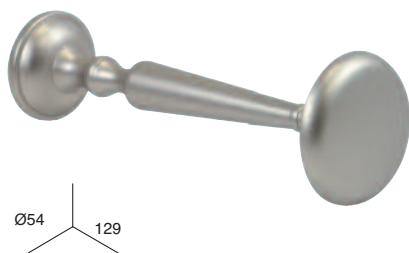

REF.	4597**2	4597**4
	x 1	x 1
	x 10	
A	6,72 €/bl.	6,31 €/u.
B	6,94 €/bl.	6,50 €/u.

TIRADOR 1,00 M. CON MOSQUETÓN  
(No disponible en blanco y níquel negro)



REF.	4599**2	4599**4
	x 1	x 1
	x 25	
A	12,45 €/bl.	11,72 €/u.
B	12,86 €/bl.	12,11 €/u.

NOTA: Envasado en bolsa (.4), el pedido mínimo es de 10 unidades.

\*\* Colores A: 42= Níquel mate.  
\*\* Colores B: 43= Cromado. 44= Dorado. 46= Bronce satinado. 47= Bronce viejo. 50= Níquel negro. 51= Titanio mate.  
Código de envasado: 2= Blister. 4= Bolsa de protección.



## COLORES



**42.**  
NÍQUEL mate



**47.**  
BRONCE viejo



**49.**  
ACERO inoxidable

## TUBO 20x20 mm.



REFERENCIA	<---->		NÍQUEL mate	BRONCE viejo	ACERO inoxidable
4733**3	1,50 m.	x 5	15,04 €/u.	15,67 €/u.	15,67 €/u.
4734**3	2,00 m.	x 5	19,41 €/u.	20,29 €/u.	20,29 €/u.
4735**3	2,50 m.	x 5	23,91 €/u.	24,93 €/u.	24,93 €/u.
4736**3	3,00 m.	x 5	28,01 €/u.	29,23 €/u.	29,23 €/u.

NOTA: Corte de barra 1 € (Referencia 9999989)

## ACCESORIOS 20x20 mm.

ANILLA

EMPALME

RECOGE-CORTINAS

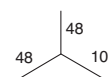
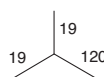

REF.	4738**2	4738**4	4737422	4737424	4746**2	4746**4
	x 10	x 1	x 1	x 1	x 1	x 1
	x 10		x 10		x 10	
42	17,35 €/bl.	1,64 €/u.	3,57 €/bl.	3,37 €/u.	7,12 €/bl.	6,69 €/u.
47	18,06 €/bl.	1,71 €/u.	-	-	7,66 €/bl.	7,20 €/u.
49	18,06 €/bl.	1,71 €/u.	-	-	7,66 €/bl.	7,20 €/u.

NOTA: Envasado en bolsa (.4), el pedido mínimo es de 10 unidades. Anillas en bolsa (.4), el pedido mínimo es de 100 unidades.

\*\* Colores: 42= Níquel mate. 47= Bronce viejo. 49= Acero inoxidable.  
Código de envasado: 2= Blister. 3= Skin. 4= Bolsa de protección.

ZIRCONIO 20x20 mm.



# ACCESORIOS 20x20 mm.

TERMINAL TAPÓN

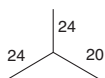

TERMINAL CUADRADO

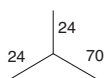
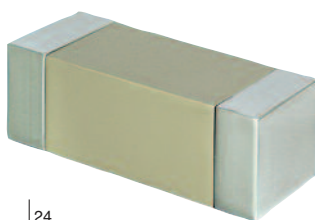

TERMINAL "DECO"

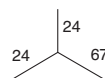

REF.	4745**2	4745**4	4743**2	4743**4	4744**2	4744**4
	x 2	x 1	x 2	x 1	x 2	x 1
	x 10		x 10		x 10	
42	6,49 €/bl.	3,07 €/u.	12,37 €/bl.	5,81 €/u.	10,05 €/bl.	4,73 €/u.
47	6,61 €/bl.	3,11 €/u.	12,91 €/bl.	6,07 €/u.	10,31 €/bl.	4,84 €/u.
49	6,61 €/bl.	3,11 €/u.	12,91 €/bl.	6,07 €/u.	10,31 €/bl.	4,84 €/u.

SOPORTE CENTRAL

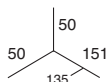
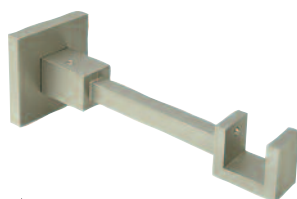

SOPORTE DOBLE

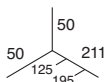
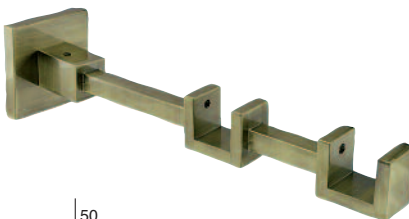

SOPORTE EXTENSIBLE

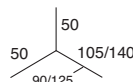
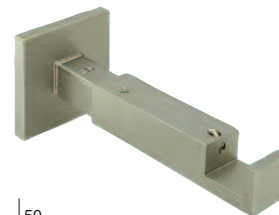

REF.	4739**2	4739**4	4740**2	4740**4	4750**2	4750**4
	x 1	x 1	x 1	x 1	x 1	x 1
	x 10		x 10		x 10	
42	9,81 €/bl.	9,20 €/u.	11,16 €/bl.	10,51 €/u.	11,24 €/bl.	10,55 €/u.
47	10,14 €/bl.	9,54 €/u.	11,71 €/bl.	11,02 €/u.	11,80 €/bl.	11,10 €/u.
49	10,14 €/bl.	9,54 €/u.	11,71 €/bl.	11,02 €/u.	11,80 €/bl.	11,10 €/u.

SOPORTE LATERAL

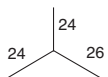

SOPORTE TECHO

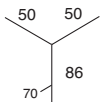

REF.	4742**2	4742**4	4741**2	4741**4
	x 2	x 1	x 1	x 1
	x 10		x 10	
42	8,37 €/bl.	3,94 €/u.	8,80 €/bl.	8,27 €/u.
47	8,55 €/bl.	4,01 €/u.	9,25 €/bl.	8,69 €/u.
49	8,55 €/bl.	4,01 €/u.	9,25 €/bl.	8,69 €/u.

NOTA: Envasado en bolsa (.4), el pedido mínimo es de 10 unidades.

\*\* Colores: 42= Níquel mate. 47= Bronce viejo. 49= Acero inoxidable.  
Código de envasado: 2= Blister.





# SUGERENCIAS DE MONTAJE 20x20 mm.

(Con soporte frente 4739\*\*4)

COMPONENTES NECESARIOS			
REF. Tubo 20x20 (Skin)	Anillas 4738**4	Soporte 4739**4	Terminales
4733**3 (1,50 m.)	16 unidades	2 soportes	2 terminales
4734**3 (2,00 m.)	20 unidades	2 soportes	2 terminales
4735**3 (2,50 m.)	26 unidades	3 soportes	2 terminales
4736**3 (3,00 m.)	30 unidades	3 soportes	2 terminales

TERMINAL "TAPÓN"

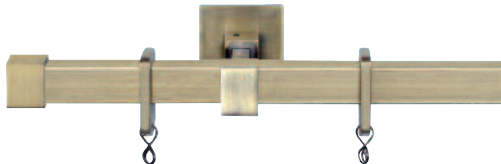

<---->	42	47 / 49
(1,50 m.)	65,82 €	68,33 €
(2,00 m.)	76,75 €	79,79 €
(2,50 m.)	100,29 €	104,23 €
(3,00 m.)	110,95 €	115,37 €

TERMINAL "CUADRADO"

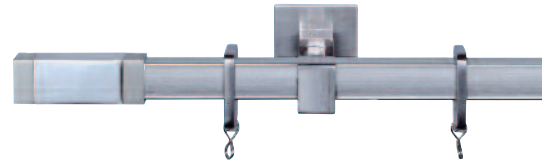

<---->	42	47 / 49
(1,50 m.)	71,30 €	74,25 €
(2,00 m.)	82,23 €	85,71 €
(2,50 m.)	105,77 €	110,15 €
(3,00 m.)	116,43 €	121,29 €

TERMINAL "DECO"



<---->	42	47 / 49
(1,50 m.)	69,14 €	71,79 €
(2,00 m.)	80,07 €	83,25 €
(2,50 m.)	103,61 €	107,69 €
(3,00 m.)	114,27 €	118,83 €

TERMINAL "TAPÓN"

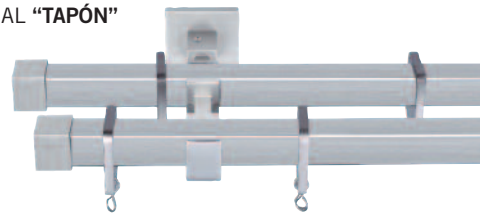

<---->	42	47 / 49
(1,50 m.)	115,86 €	120,54 €
(2,00 m.)	137,72 €	143,46 €
(2,50 m.)	176,91 €	184,28 €
(3,00 m.)	198,23 €	206,56 €

TERMINAL "CUADRADO"

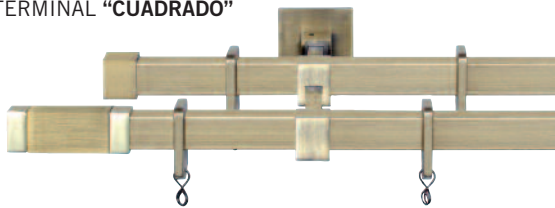

<---->	42	47 / 49
(1,50 m.)	121,34 €	126,46 €
(2,00 m.)	143,20 €	149,38 €
(2,50 m.)	182,39 €	190,20 €
(3,00 m.)	203,71 €	212,48 €

TERMINAL "DECO"

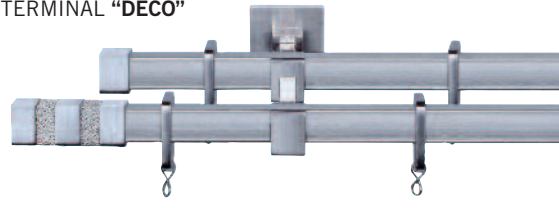

<---->	42	47 / 49
(1,50 m.)	119,18 €	124,00 €
(2,00 m.)	141,04 €	146,92 €
(2,50 m.)	180,23 €	187,74 €
(3,00 m.)	201,55 €	210,02 €

# SUGERENCIAS DE MONTAJE 20x20 mm.

Riel doble 20x20 mm. (Con soporte doble 4740\*\*4 y terminal posterior tapón 4745\*\*4)

COMPONENTES NECESARIOS			
REF. Tubo 20x20 (Skin)	Anillas 4738**4	Soporte 4740**4	Terminales
4733**3 x 2 (1,50 m.)	32 unidades	2 soportes	2+2 terminales
4734**3 x 2 (2,00 m.)	40 unidades	2 soportes	2+2 terminales
4735**3 x 2 (2,50 m.)	52 unidades	3 soportes	2+2 terminales
4736**3 x 2 (3,00 m.)	60 unidades	3 soportes	2+2 terminales

\*\* Colores: 42= Níquel mate. 47= Bronce viejo. 49= Acero inoxidable.



# Gama Élite





## COLORES



**47.**  
BRONCE viejo



**49.**  
ACERO inoxidable

## TUBO GAMA ÉLITE Ø28 mm.



REFERENCIA	<---->		47. BRONCE viejo	49. ACERO inoxidable
4756**0	1,50 m.	x 1	59,57 €/u.	59,57 €/u.
4757**0	2,00 m.	x 1	79,04 €/u.	79,04 €/u.
4758**0	2,50 m.	x 1	98,53 €/u.	98,53 €/u.
4759**0	3,00 m.	x 1	118,17 €/u.	118,17 €/u.

## TUBO GAMA ÉLITE Ø20 mm.



REFERENCIA	<---->		47. BRONCE viejo	49. ACERO inoxidable
4778**0	1,50 m.	x 1	42,18 €/u.	42,18 €/u.
4779**0	2,00 m.	x 1	56,13 €/u.	56,13 €/u.
4780**0	2,50 m.	x 1	70,05 €/u.	70,05 €/u.
4781**0	3,00 m.	x 1	83,97 €/u.	83,97 €/u.

\*\* Colores: 47= Bronce viejo. 49= Acero inoxidable.  
Código de envasado: 0= Granel.



# ACCESORIOS Ø28 y Ø20 mm.

ANILLA PLANA



Ø IN. 42  
Ø EX. 52,5

Ø IN. 28  
Ø EX. 36,5

SOPORTE ABIERTO



Ø49,5 118  
100

Ø49,5 110  
95

SOPORTE LATERAL



Ø39,5 20

Ø39,5 15,5

REF.	4751**4	4774**4	4768**4	4790**4	4794**4	4795**4
Ø	28 mm.	20 mm.	28 mm.	20 mm.	28 mm.	20 mm.
	x 1	x 1	x 1	x 1	x 1	x 1
A	2,21 €/u.	1,64 €/u.	16,17 €/u.	16,17 €/u.	7,27 €/u.	7,27 €/u.
B	2,21 €/u.	1,64 €/u.	17,37 €/u.	17,37 €/u.	7,80 €/u.	7,80 €/u.

SOPORTE ABIERTO LARGO



Ø49,5 178  
160

Ø49,5 171  
157

ENLACE PARA SOPORTE DOBLE



31 51,5  
17

25,5 48  
17

SOPORTE TECHO



49,5 73 22 E/C  
83 65

49,5 64 18 E/C  
79,5 65

REF.	4769**4	4791**4	4755**4	4777**4	4752**4	4775**4
Ø	28 mm.	20 mm.	28 mm.	20 mm.	28 mm.	20 mm.
	x 1	x 1	x 1	x 1	x 1	x 1
A	17,63 €/u.	17,63 €/u.	10,50 €/u.	8,23 €/u.	18,84 €/u.	18,84 €/u.
B	18,86 €/u.	18,86 €/u.	10,98 €/u.	8,39 €/u.	19,34 €/u.	19,34 €/u.

SOPORTE TECHO DOBLE

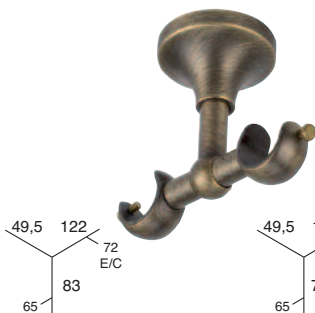

49,5 122 72 E/C  
83 65

49,5 106 66 E/C  
79,5 65

SOPORTE TECHO DOBLE 28-20



49,5 114 60 E/C  
83 65

TERMINAL "GÉNOVA"



Ø38,5 71

Ø30 60

REF.	4753**4	4776**4	4754**4	4767**4	4789**4
Ø	28 mm.	20 mm.	28 - 20 mm.	28 mm.	20 mm.
	x 1	x 1	x 1	x 1	x 1
A	28,33 €/u.	28,33 €/u.	28,33 €/u.	17,58 €/u.	12,85 €/u.
B	29,23 €/u.	29,23 €/u.	29,23 €/u.	18,94 €/u.	13,98 €/u.

\*\* Colores A: 47= Bronce viejo.  
\*\* Colores B: 49= Acero inoxidable.  
Código de envasado: 4= Bolsa de protección.



# ACCESORIOS Ø28 y Ø20 mm.

TERMINAL "MILÁN"

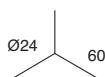
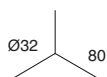

TERMINAL "TURÍN"

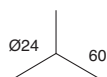
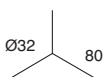

TERMINAL "BARI"

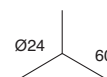
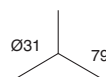

REF.	4765**4	4787**4	4766**4	4788**4	4764**4	4786**4
Ø	28 mm.	20 mm.	28 mm.	20 mm.	28 mm.	20 mm.
	x 1	x 1	x 1	x 1	x 1	x 1
A	17,19 €/u.	10,68 €/u.	19,73 €/u.	13,05 €/u.	20,38 €/u.	12,39 €/u.
B	18,91 €/u.	11,82 €/u.	20,80 €/u.	14,35 €/u.	21,67 €/u.	13,59 €/u.

TERMINAL "ROMA"

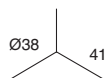
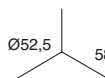

TERMINAL "LIVORNO"

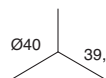
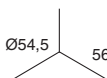

TERMINAL "PISA"

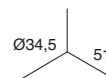
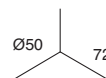

REF.	4760**4	4782**4	4761**4	4783**4	4762**4	4784**4
Ø	28 mm.	20 mm.	28 mm.	20 mm.	28 mm.	20 mm.
	x 1	x 1	x 1	x 1	x 1	x 1
A	17,42 €/u.	12,43 €/u.	17,79 €/u.	11,45 €/u.	18,27 €/u.	11,41 €/u.
B	18,78 €/u.	13,72 €/u.	19,17 €/u.	12,80 €/u.	19,96 €/u.	12,78 €/u.

TERMINAL "NÁPOLES"

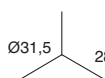
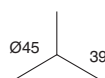

TERMINAL TAPÓN

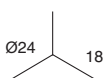
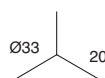
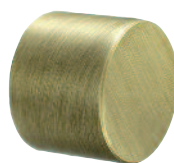

TERMINAL TAPÓN TOPE ANILLAS

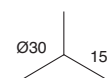
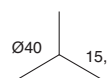

REF.	4763**4	4785**4	4792**4	4793**4	4798**4	4799**4
Ø	28 mm.	20 mm.	28 mm.	20 mm.	28 mm.	20 mm.
	x 1	x 1	x 1	x 1	x 1	x 1
A	15,06 €/u.	9,21 €/u.	7,40 €/u.	5,89 €/u.	10,31 €/u.	7,54 €/u.
B	16,37 €/u.	10,02 €/u.	7,79 €/u.	6,42 €/u.	11,19 €/u.	8,19 €/u.

\*\* Colores A: 47= Bronce viejo.  
 \*\* Colores B: 49= Acero inoxidable.  
 Código de envasado: 4= Bolsa de protección.

# SUGERENCIAS DE MONTAJE Ø28 mm.

(Con soporte frente 4768\*\*4)

## COMPONENTES NECESARIOS

REF. Tubo Ø28 (A granel)	Anilla 4751**4	Soporte 4768**4	Terminales
4756**0 (1,50 m.)	16 unidades	2 soportes	2 terminales
4757**0 (2,00 m.)	20 unidades	2 soportes	2 terminales
4758**0 (2,50 m.)	26 unidades	3 soportes	2 terminales
4759**0 (3,00 m.)	30 unidades	3 soportes	2 terminales

### TERMINAL "GÉNOVA"

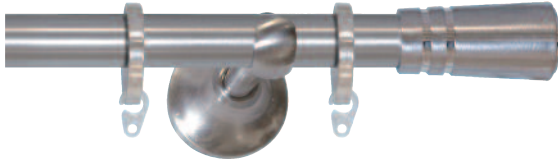

←----→	47	49
(1,50 m.)	162,43 €	167,55 €
(2,00 m.)	190,74 €	195,86 €
(2,50 m.)	239,66 €	245,98 €
(3,00 m.)	268,14 €	274,46 €

### TERMINAL "TURÍN"

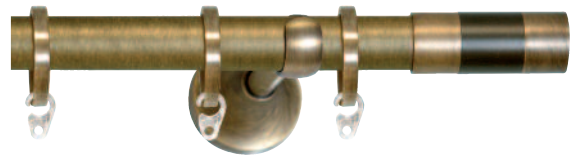

←----→	47	49
(1,50 m.)	166,73 €	171,27 €
(2,00 m.)	195,04 €	199,58 €
(2,50 m.)	243,96 €	249,70 €
(3,00 m.)	272,44 €	278,18 €

### TERMINAL "MILÁN"

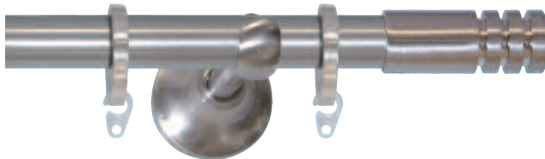

←----→	47	49
(1,50 m.)	161,65 €	167,49 €
(2,00 m.)	189,96 €	195,80 €
(2,50 m.)	238,88 €	245,92 €
(3,00 m.)	267,36 €	274,40 €

### TERMINAL "BARI"



←----→	47	49
(1,50 m.)	168,03 €	173,01 €
(2,00 m.)	196,34 €	201,32 €
(2,50 m.)	245,26 €	251,44 €
(3,00 m.)	273,74 €	279,92 €

### TERMINAL "LIVORNO"



←----→	47	49
(1,50 m.)	162,85 €	168,01 €
(2,00 m.)	191,16 €	196,32 €
(2,50 m.)	240,08 €	246,44 €
(3,00 m.)	268,56 €	274,92 €

### TERMINAL "ROMA"

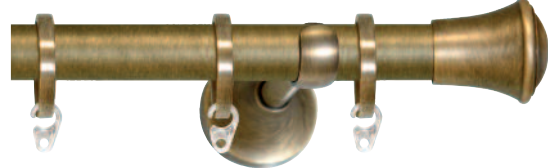

←----→	47	49
(1,50 m.)	162,11 €	167,23 €
(2,00 m.)	190,42 €	195,54 €
(2,50 m.)	239,34 €	245,66 €
(3,00 m.)	267,82 €	274,14 €

### TERMINAL "NÁPOLES"

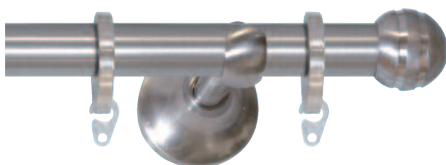

←----→	47	49
(1,50 m.)	157,39 €	162,41 €
(2,00 m.)	185,70 €	190,72 €
(2,50 m.)	234,62 €	240,84 €
(3,00 m.)	263,10 €	269,32 €

### TERMINAL "PISA"



←----→	47	49
(1,50 m.)	163,81 €	169,59 €
(2,00 m.)	192,12 €	197,90 €
(2,50 m.)	241,04 €	248,02 €
(3,00 m.)	269,52 €	276,50 €

\*\* Colores: 47= Bronce viejo. 49= Acero inoxidable.

# SUGERENCIAS DE MONTAJE Ø20 mm.

(Con soporte frente 4768\*\*4)

## COMPONENTES NECESARIOS

REF. Tubo Ø20 (A granel)	Anilla 4774**4	Soporte 4790**4	Terminales
4778**0 (1,50 m.)	16 unidades	2 soportes	2 terminales
4779**0 (2,00 m.)	20 unidades	2 soportes	2 terminales
4780**0 (2,50 m.)	26 unidades	3 soportes	2 terminales
4781**0 (3,00 m.)	30 unidades	3 soportes	2 terminales

### TERMINAL "GÉNOVA"



<---->	47	49
(1,50 m.)	126,46 €	131,12 €
(2,00 m.)	146,97 €	151,63 €
(2,50 m.)	186,90 €	192,76 €
(3,00 m.)	207,38 €	213,24 €

### TERMINAL "TURÍN"



<---->	47	49
(1,50 m.)	126,86 €	131,86 €
(2,00 m.)	147,37 €	152,37 €
(2,50 m.)	187,30 €	193,50 €
(3,00 m.)	207,78 €	213,98 €

### TERMINAL "MILÁN"

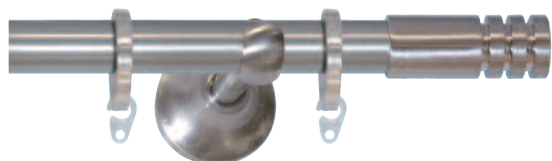

<---->	47	49
(1,50 m.)	122,12 €	126,80 €
(2,00 m.)	142,63 €	147,31 €
(2,50 m.)	182,56 €	188,44 €
(3,00 m.)	203,04 €	208,92 €

### TERMINAL "BARI"



<---->	47	49
(1,50 m.)	125,54 €	130,34 €
(2,00 m.)	146,05 €	150,85 €
(2,50 m.)	185,98 €	191,98 €
(3,00 m.)	206,46 €	212,46 €

### TERMINAL "LIVORNO"

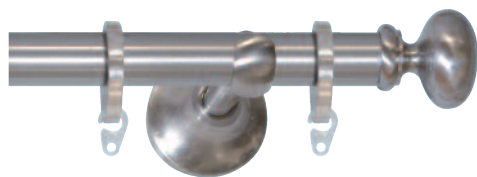

<---->	47	49
(1,50 m.)	123,66 €	128,76 €
(2,00 m.)	144,17 €	149,27 €
(2,50 m.)	184,10 €	190,40 €
(3,00 m.)	204,58 €	210,88 €

### TERMINAL "ROMA"



<---->	47	49
(1,50 m.)	125,62 €	130,60 €
(2,00 m.)	146,13 €	151,11 €
(2,50 m.)	186,06 €	192,24 €
(3,00 m.)	206,54 €	212,72 €

### TERMINAL "NÁPOLES"

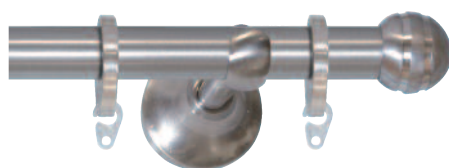

<---->	47	49
(1,50 m.)	119,18 €	123,20 €
(2,00 m.)	139,69 €	143,71 €
(2,50 m.)	179,62 €	184,84 €
(3,00 m.)	200,10 €	205,32 €

### TERMINAL "PISA"

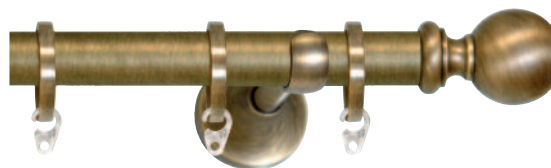

<---->	47	49
(1,50 m.)	123,58 €	128,72 €
(2,00 m.)	144,09 €	149,23 €
(2,50 m.)	184,02 €	190,36 €
(3,00 m.)	204,50 €	210,84 €

\*\* Colores: 47= Bronce viejo. 49= Acero inoxidable.





# SUGERENCIAS DE MONTAJE Ø28-20 mm.

## Riel doble 28-20 mm.

(Con soporte largo 4769\*\*4, accesorio para soporte 4777\*\*4 y terminal posterior tapón 4793\*\*4)

### COMPONENTES NECESARIOS

REF. Tubo Ø28+Ø20 (A granel)	Anillas 4751**4 + 4774**4	Soporte (4769) + accesorio (4777)	Terminales
4756**0 + 4778**0 (1,50 m.)	16 + 16 unidades	2 soportes + 2 accesorios	2 + 2 terminales
4757**0 + 4779**0 (2,00 m.)	20 + 20 unidades	2 soportes + 2 accesorios	2 + 2 terminales
4758**0 + 4780**0 (2,50 m.)	26 + 26 unidades	3 soportes + 2 accesorios	2 + 2 terminales
4759**0 + 4781**0 (3,00 m.)	30 + 30 unidades	3 soportes + 2 accesorios	2 + 2 terminales

#### TERMINAL "GÉNOVA"

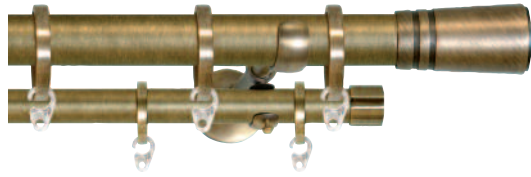

<---->	47	49
(1,50 m.)	262,01 €	268,57 €
(2,00 m.)	310,83 €	317,39 €
(2,50 m.)	393,20 €	401,15 €
(3,00 m.)	442,16 €	450,11 €

#### TERMINAL "TURÍN"

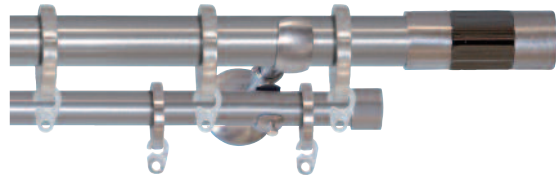

<---->	47	49
(1,50 m.)	266,31 €	272,29 €
(2,00 m.)	315,13 €	321,11 €
(2,50 m.)	397,50 €	404,87 €
(3,00 m.)	446,46 €	453,83 €

#### TERMINAL "MILÁN"

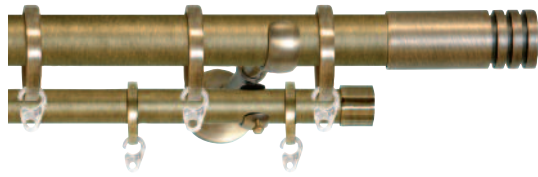

<---->	47	49
(1,50 m.)	261,23 €	268,51 €
(2,00 m.)	310,05 €	317,33 €
(2,50 m.)	392,42 €	401,09 €
(3,00 m.)	441,38 €	450,05 €

#### TERMINAL "BARI"

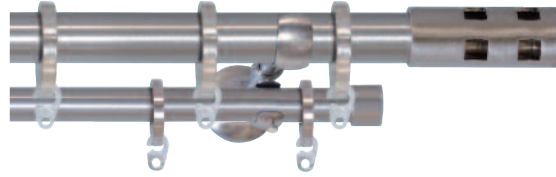

<---->	47	49
(1,50 m.)	267,61 €	274,03 €
(2,00 m.)	316,43 €	322,85 €
(2,50 m.)	398,80 €	406,61 €
(3,00 m.)	447,76 €	455,57 €

#### TERMINAL "LIVORNO"

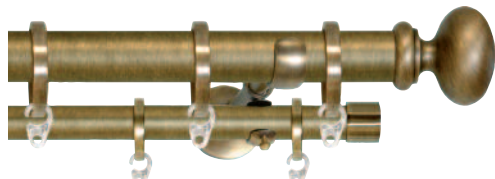

<---->	47	49
(1,50 m.)	262,43 €	269,03 €
(2,00 m.)	311,25 €	317,85 €
(2,50 m.)	393,62 €	401,61 €
(3,00 m.)	442,58 €	450,57 €

#### TERMINAL "ROMA"

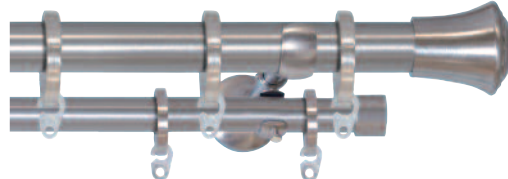

<---->	47	49
(1,50 m.)	261,69 €	268,25 €
(2,00 m.)	310,51 €	317,07 €
(2,50 m.)	392,88 €	400,83 €
(3,00 m.)	441,84 €	449,79 €

#### TERMINAL "NÁPOLES"

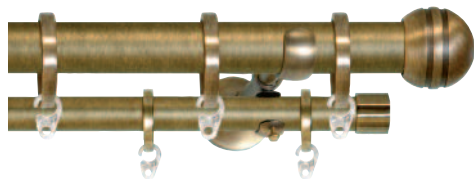

<---->	47	49
(1,50 m.)	256,97 €	263,43 €
(2,00 m.)	305,79 €	312,25 €
(2,50 m.)	388,16 €	396,01 €
(3,00 m.)	437,12 €	444,97 €

#### TERMINAL "PISA"

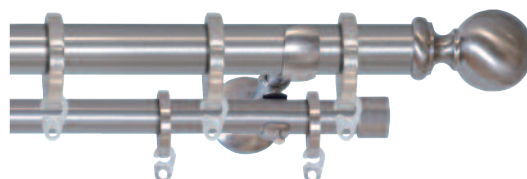

<---->	47	49
(1,50 m.)	263,39 €	270,61 €
(2,00 m.)	312,21 €	319,43 €
(2,50 m.)	394,58 €	403,19 €
(3,00 m.)	443,54 €	452,15 €

\*\* Colores: 47= Bronce viejo. 49= Acero inoxidable.

# SUGERENCIAS DE MONTAJE Ø20-20 mm.

## Riel doble 20-20 mm.

(Con soporte largo 4791\*\*4, accesorio para soporte 4777\*\*4 y terminal posterior tapón 4793\*\*4)

### COMPONENTES NECESARIOS

REF. Tubo Ø20+Ø20 (A granel)	Anilla 4774**4	Soporte (4791) + accesorio (4777)	Terminales
4778**0 x 2 (1,50 m.)	16 + 16 unidades	2 soportes + 2 accesorios	2 + 2 terminales
4779**0 x 2 (2,00 m.)	20 + 20 unidades	2 soportes + 2 accesorios	2 + 2 terminales
4780**0 x 2 (2,50 m.)	26 + 26 unidades	3 soportes + 2 accesorios	2 + 2 terminales
4781**0 x 2 (3,00 m.)	30 + 30 unidades	3 soportes + 2 accesorios	2 + 2 terminales

#### TERMINAL "GÉNOVA"

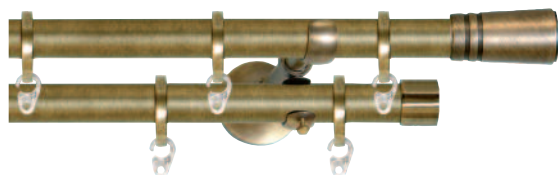

<---->	47	49
(1,50 m.)	226,04 €	232,14 €
(2,00 m.)	267,06 €	273,16 €
(2,50 m.)	340,44 €	347,93 €
(3,00 m.)	381,40 €	388,89 €

#### TERMINAL "TURÍN"

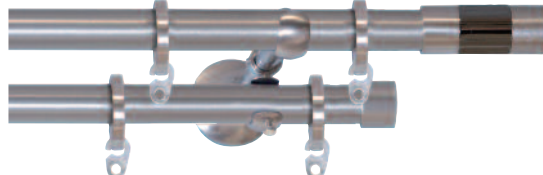

<---->	47	49
(1,50 m.)	226,44 €	232,88 €
(2,00 m.)	267,46 €	273,90 €
(2,50 m.)	340,84 €	348,67 €
(3,00 m.)	381,80 €	389,63 €

#### TERMINAL "MILÁN"

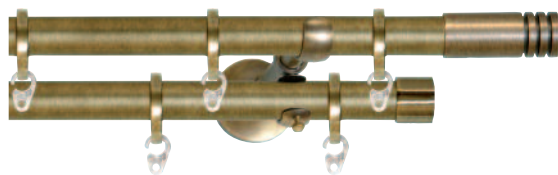

<---->	47	49
(1,50 m.)	221,70 €	227,82 €
(2,00 m.)	262,72 €	268,84 €
(2,50 m.)	336,10 €	343,61 €
(3,00 m.)	377,06 €	384,57 €

#### TERMINAL "BARI"

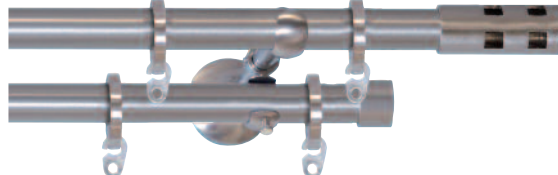

<---->	47	49
(1,50 m.)	225,12 €	231,36 €
(2,00 m.)	266,14 €	272,38 €
(2,50 m.)	339,52 €	347,15 €
(3,00 m.)	380,48 €	388,11 €

#### TERMINAL "LIVORNO"

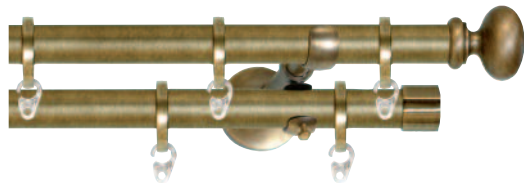

<---->	47	49
(1,50 m.)	223,24 €	229,78 €
(2,00 m.)	264,26 €	270,80 €
(2,50 m.)	337,64 €	345,57 €
(3,00 m.)	378,60 €	386,53 €

#### TERMINAL "ROMA"

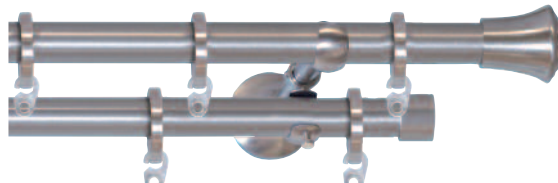

<---->	47	49
(1,50 m.)	225,20 €	231,62 €
(2,00 m.)	266,22 €	272,64 €
(2,50 m.)	339,60 €	347,41 €
(3,00 m.)	380,56 €	388,37 €

#### TERMINAL "NÁPOLES"

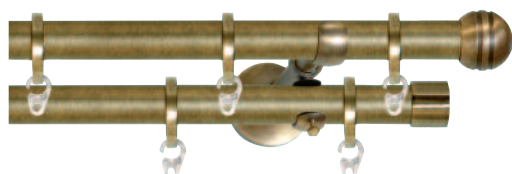

<---->	47	49
(1,50 m.)	218,76 €	224,22 €
(2,00 m.)	259,78 €	265,24 €
(2,50 m.)	333,16 €	340,01 €
(3,00 m.)	374,12 €	380,97 €

#### TERMINAL "PISA"

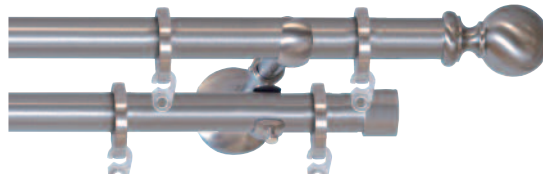

<---->	47	49
(1,50 m.)	223,16 €	229,74 €
(2,00 m.)	264,18 €	270,76 €
(2,50 m.)	337,56 €	345,53 €
(3,00 m.)	378,52 €	386,49 €

\*\* Colores: 47= Bronce viejo. 49= Acero inoxidable.



СНУС



# Forja



## COLORES



06. BLANCO



07. NEGRO

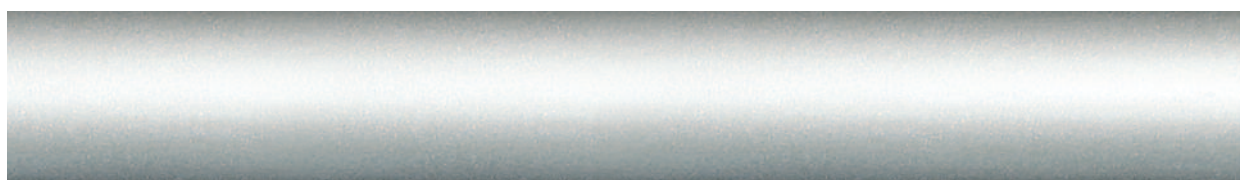

60. PERLA (Contrapedido)



62. MARFIL-ORO



63. ÓXIDO

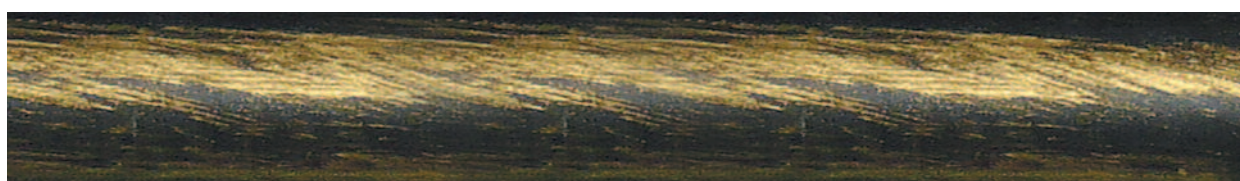

69. NEGRO-DORADO



# TUBO FORJA Ø28 mm.



REFERENCIA	←----→			COLORES A	COLORES B	COLORES C
4053**3	1,50 m.	x 6		10,59 €/u.	11,83 €/u.	12,99 €/u.
4054**3	2,00 m.	x 6		13,87 €/u.	15,52 €/u.	17,15 €/u.
4055**3	2,50 m.	x 6		17,19 €/u.	19,32 €/u.	21,19 €/u.
4056**3	3,00 m.	x 6		20,52 €/u.	23,03 €/u.	25,32 €/u.

NOTA: Corte de barra 1 € (Referencia 9999989)

## ACCESORIOS

ANILLA



Ø IN. 39,5  
Ø EX. 50

ANILLO SILENCIADOR



Ø41/Ø37  
7,5

EMPALME (Bicromatado)



120  
Ø27

REF.	4052**2	4052**4	4363**2	4363**4	4070442	4070444
	x 10	x 1	x 10	x 1	x 1	x 1
	x 10		x 10		x 10	
A	10,67 €/bl.	1,01 €/bs.	07 1,93 €/bl.	0,18 €/bs.	6,82 €/bl.	6,43 €/bs.
B	12,99 €/bl.	1,22 €/bs.	20 1,93 €/bl.	0,18 €/bs.	-	-
C	14,45 €/bl.	1,34 €/bs.	-	-	-	-

CODO



Ø28  
350 160

RECOGE-CORTINAS CURVADO



35  
255 103

SOPORTE LATERAL



85  
28 35

REF.	4137**0	4099**2	4099**4	4048**2	4048**4
	x 1	x 1	x 1	x 2	x 1
		x 10		x 10	
A	5,58 €/u.	13,00 €/bl.	12,19 €/bs.	22,01 €/bl.	10,35 €/bs.
B	6,15 €/u.	14,66 €/bl.	13,73 €/bs.	22,40 €/bl.	10,52 €/bs.
C	6,47 €/u.	14,79 €/bl.	13,90 €/bs.	22,76 €/bl.	10,70 €/bs.

NOTA: Envasado en bolsa (.4), el pedido mínimo es de 10 unidades. Anillas en bolsa (.4), el pedido mínimo es de 100 unidades.

\*\* Colores A: 07= Negro.

\*\* Colores B: 60= Perla. 63= Óxido. 69= Negro-Dorado.

\*\* Colores C: 06= Blanco. 62= Marfil-Oro.

Código de envasado: 2= Blister. 3= Skin. 4= Bolsa de protección.

FORJA Ø28 mm.

# ACCESORIOS

SOPORTE CENTRAL

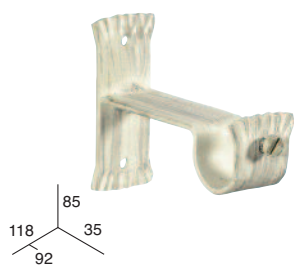

SOPORTE EXTENSIBLE

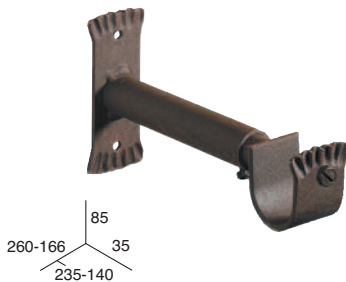

SOPORTE DOBLE 28-28 mm.



REF.	4047**2	4047**4	4101**2	4101**4	4049**2	4049**4
	x 2	x 1	x 1	x 1	x 1	x 1
	x 10		x 10		x 10	
A	13,35 €/bl.	6,28 €/bs.	12,88 €/bl.	12,11 €/bs.	10,84 €/bl.	10,18 €/bs.
B	14,55 €/bl.	6,84 €/bs.	13,68 €/bl.	12,90 €/bs.	11,78 €/bl.	11,11 €/bs.
C	14,66 €/bl.	6,89 €/bs.	14,08 €/bl.	13,24 €/bs.	12,10 €/bl.	11,36 €/bs.

SOPORTE DOBLE 28-20 mm.

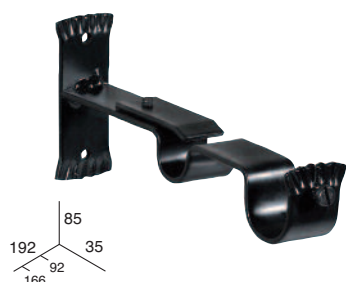

SOPORTE LARGO

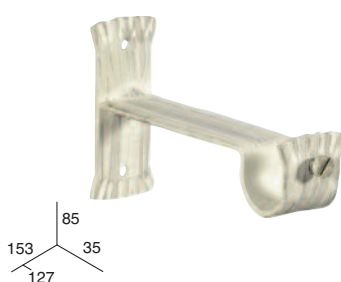

SOPORTE "MODERNISTA"



REF.	4050**2	4050**4	4051**2	4051**4	4152**2	4152**4
	x 1	x 1	x 1	x 1	x 1	x 1
	x 10		x 10		x 10	
A	10,71 €/bl.	10,06 €/bs.	8,88 €/bl.	8,35 €/bs.	9,05 €/bl.	8,52 €/bs.
B	11,57 €/bl.	10,89 €/bs.	9,53 €/bl.	8,97 €/bs.	9,51 €/bl.	8,94 €/bs.
C	11,84 €/bl.	11,10 €/bs.	9,63 €/bl.	9,05 €/bs.	9,85 €/bl.	9,27 €/bs.

SOPORTE TECHO

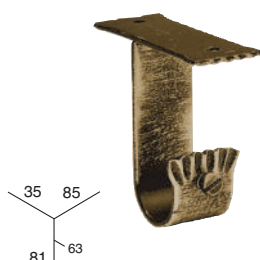

REF.	4046**2	4046**4
	x 2	x 1
	x 10	
A	14,03 €/bl.	6,60 €/bs.
B	15,28 €/bl.	7,17 €/bs.
C	15,45 €/bl.	7,27 €/bs.

**NOTA:** Envasado en bolsa (.4), el pedido mínimo es de 10 unidades. Anillas en bolsa (.4), el pedido mínimo es de 100 unidades.

\*\* Colores A: 07= Negro.

\*\* Colores B: 60= Perla. 63= Óxido. 69= Negro-Dorado.

\*\* Colores C: 06= Blanco. 62= Marfil-Oro.

Código de envasado: 2= Blister. 4= Bolsa de protección.





# TERMINALES

TERMINAL TAPÓN

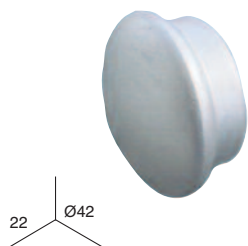

TERMINAL "ESFERA RAYADA"

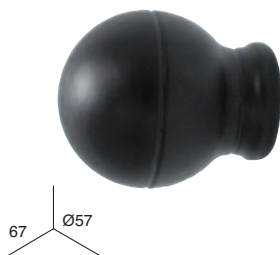

TERMINAL "IBIZA"

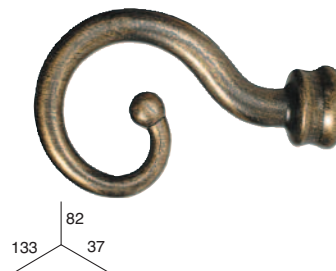

REF.	4069**2	4069**4	4106**2	4106**4	4058**2	4058**4
	x 2	x 1	x 1	x 1	x 1	x 1
	x 10		x 10		x 10	
A	5,42 €/bl.	2,56 €/bs.	9,98 €/bl.	9,39 €/bs.	8,40 €/bl.	7,91 €/bs.
B	5,80 €/bl.	2,72 €/bs.	10,58 €/bl.	9,93 €/bs.	8,98 €/bl.	8,44 €/bs.
C	6,05 €/bl.	2,84 €/bs.	11,13 €/bl.	10,46 €/bs.	9,13 €/bl.	8,58 €/bs.

TERMINAL "PARÍS"

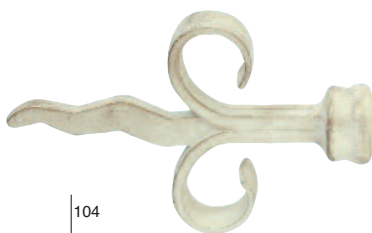

TERMINAL "PIÑA"

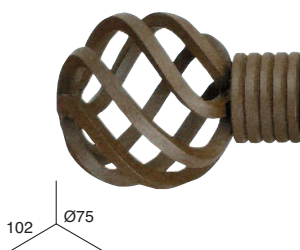

TERMINAL "LIRA"

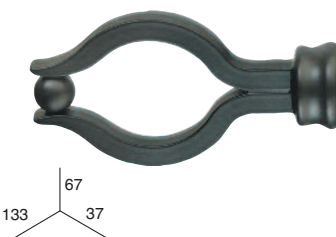

REF.	4059**2	4059**4	4060**2	4060**4	4067**2	4067**4
	x 1	x 1	x 1	x 1	x 1	x 1
	x 10		x 10		x 10	
A	8,90 €/bl.	8,38 €/bs.	16,84 €/bl.	15,80 €/bs.	8,04 €/bl.	7,56 €/bs.
B	9,32 €/bl.	8,76 €/bs.	17,28 €/bl.	16,25 €/bs.	8,64 €/bl.	8,12 €/bs.
C	9,65 €/bl.	9,06 €/bs.	17,56 €/bl.	16,51 €/bs.	8,95 €/bl.	8,40 €/bs.

TERMINAL "HOJAS"



REF.	4609**2	4609**4
	x 1 juego	x 1 juego
	x 10	
A	13,62 €/bl.	12,80 €/bs.
B	14,66 €/bl.	13,77 €/bs.
C	15,35 €/bl.	14,43 €/bs.

NOTA: Envasado en bolsa (.4), el pedido mínimo es de 10 unidades. Anillas en bolsa (.4), el pedido mínimo es de 100 unidades.

\*\* Colores A: 07= Negro.  
 \*\* Colores B: 60= Perla. 63= Óxido. 69= Negro-Dorado.  
 \*\* Colores C: 06= Blanco. 62= Marfil-Oro.  
 Código de envasado: 2= Blister. 4= Bolsa de protección.

FORJA Ø28 mm.

# SUGERENCIAS DE MONTAJE Ø28 mm.

(Con soporte frente 4047\*\*4 y anillas)

## COMPONENTES NECESARIOS

REF. Tubo Ø28 (Skin)	Anillas 4052**4	Soporte 4047**4	Terminales
4053**3 (1,50 m.)	16 unidades	2 soportes	2 terminales
4054**3 (2,00 m.)	20 unidades	2 soportes	2 terminales
4055**3 (2,50 m.)	26 unidades	3 soportes	2 terminales
4056**3 (3,00 m.)	30 unidades	3 soportes	2 terminales

TERMINAL "ESFERA"

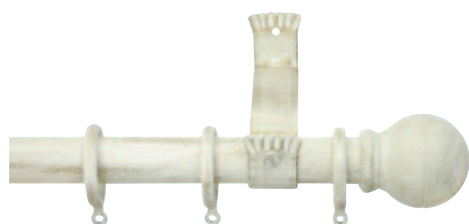

<---->	A	B	C
(1,50 m.)	58,09 €	64,89 €	69,13 €
(2,00 m.)	65,41 €	73,46 €	78,65 €
(2,50 m.)	81,07 €	91,42 €	97,62 €
(3,00 m.)	88,44 €	100,01 €	107,11 €

TERMINAL "IBIZA"



<---->	A	B	C
(1,50 m.)	55,13 €	61,91 €	65,37 €
(2,00 m.)	62,45 €	70,48 €	74,89 €
(2,50 m.)	78,11 €	88,44 €	93,86 €
(3,00 m.)	85,48 €	97,03 €	103,35 €

TERMINAL "PARÍS"

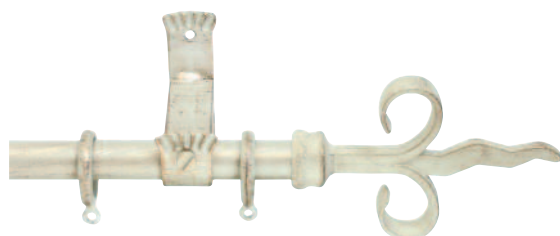

<---->	A	B	C
(1,50 m.)	56,07 €	62,55 €	66,33 €
(2,00 m.)	63,39 €	71,12 €	75,85 €
(2,50 m.)	79,05 €	89,08 €	94,82 €
(3,00 m.)	86,42 €	97,67 €	104,31 €

TERMINAL "PIÑA"

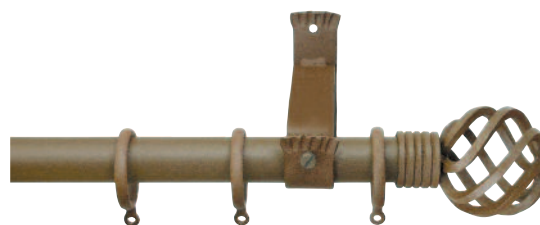

<---->	A	B	C
(1,50 m.)	70,91 €	77,53 €	81,23 €
(2,00 m.)	78,23 €	86,10 €	90,75 €
(2,50 m.)	93,89 €	104,06 €	109,72 €
(3,00 m.)	101,26 €	112,65 €	119,21 €

TERMINAL "LIRA"



<---->	A	B	C
(1,50 m.)	54,43 €	61,27 €	65,01 €
(2,00 m.)	61,75 €	69,84 €	74,53 €
(2,50 m.)	77,41 €	87,80 €	93,50 €
(3,00 m.)	84,78 €	96,39 €	102,99 €

TERMINAL "HOJAS"



<---->	A	B	C
(1,50 m.)	52,11 €	58,80 €	62,64 €
(2,00 m.)	59,43 €	67,37 €	72,16 €
(2,50 m.)	75,09 €	85,33 €	91,13 €
(3,00 m.)	82,46 €	93,92 €	100,62 €

\*\* Colores A: 07= Negro.

\*\* Colores B: 60= Perla. 63= Óxido. 69= Negro-Dorado.

\*\* Colores C: 06= Blanco. 62= Marfil-Oro.



# SUGERENCIAS DE MONTAJE Ø28-20 mm.

## Riel doble 28-20 mm.

(Con soporte doble 4050\*\*4, terminal posterior tapón 4068\*\*4 y anillas)

COMPONENTES NECESARIOS			
REF. Tubo Ø28+Ø20 (Skin)	Anillas 4052**4 + 4013**4	Soporte 4050**4	Terminales
4053**3 + 4008**3 (1,50 m.)	16 + 16 unidades	2 soportes	2 + 2 terminales
4054**3 + 4009**3 (2,00 m.)	20 + 20 unidades	2 soportes	2 + 2 terminales
4055**3 + 4010**3 (2,50 m.)	26 + 26 unidades	3 soportes	2 + 2 terminales
4056**3 + 4011**3 (3,00 m.)	30 + 30 unidades	3 soportes	2 + 2 terminales

TERMINAL "ESFERA"

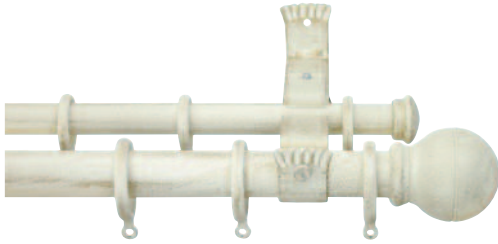

<---->	A	B	C
(1,50 m.)	88,29 €	99,07 €	107,44 €
(2,00 m.)	100,87 €	113,69 €	123,99 €
(2,50 m.)	127,02 €	143,57 €	156,32 €
(3,00 m.)	139,66 €	158,16 €	172,86 €

TERMINAL "IBIZA"

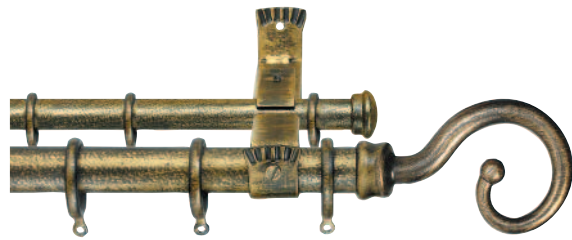

<---->	A	B	C
(1,50 m.)	85,33 €	96,09 €	103,68 €
(2,00 m.)	97,91 €	110,71 €	120,23 €
(2,50 m.)	124,06 €	140,59 €	152,56 €
(3,00 m.)	136,70 €	155,18 €	169,10 €

TERMINAL "PARÍS"

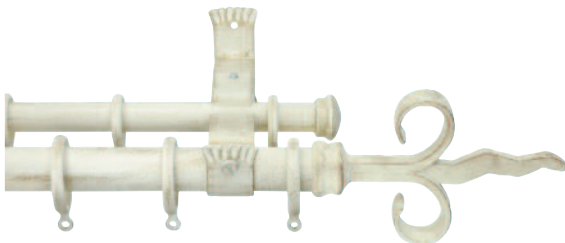

<---->	A	B	C
(1,50 m.)	86,27 €	96,73 €	104,64 €
(2,00 m.)	98,85 €	111,35 €	121,19 €
(2,50 m.)	125,00 €	141,23 €	153,52 €
(3,00 m.)	137,64 €	155,82 €	170,06 €

TERMINAL "PIÑA"

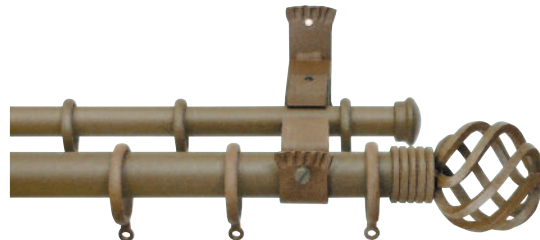

<---->	A	B	C
(1,50 m.)	101,11 €	111,71 €	119,54 €
(2,00 m.)	113,69 €	126,33 €	136,09 €
(2,50 m.)	139,84 €	156,21 €	168,42 €
(3,00 m.)	152,48 €	170,80 €	184,96 €

TERMINAL "LIRA"



<---->	A	B	C
(1,50 m.)	84,63 €	95,45 €	103,32 €
(2,00 m.)	97,21 €	110,07 €	119,87 €
(2,50 m.)	123,36 €	139,95 €	152,20 €
(3,00 m.)	136,00 €	154,54 €	168,74 €

TERMINAL "HOJAS"

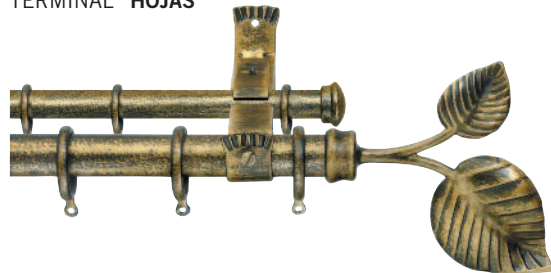

<---->	A	B	C
(1,50 m.)	82,31 €	92,98 €	100,95 €
(2,00 m.)	94,89 €	107,60 €	117,50 €
(2,50 m.)	121,04 €	137,48 €	149,83 €
(3,00 m.)	133,68 €	152,07 €	166,37 €

\*\* Colores A: 07= Negro.  
 \*\* Colores B: 60= Perla. 63= Óxido. 69= Negro-Dorado.  
 \*\* Colores C: 06= Blanco. 62= Marfil-Oro.

## COLORES



06. BLANCO

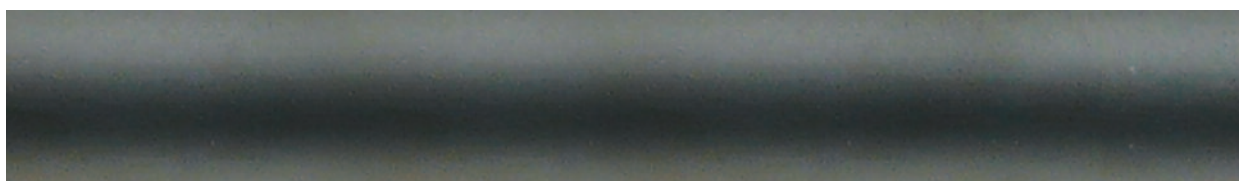

07. NEGRO



60. PERLA (Contrapedido)



62. MARFIL-ORO



63. ÓXIDO



69. NEGRO-DORADO



# TUBO FORJA Ø20 mm.



REFERENCIA	<---->			COLORES A	COLORES B	COLORES C
4007**3	1,00 m.	x 14		5,18 €/u.	5,87 €/u.	6,45 €/u.
4008**3	1,50 m.	x 14		7,68 €/u.	8,56 €/u.	9,55 €/u.
4009**3	2,00 m.	x 14		10,06 €/u.	11,17 €/u.	12,50 €/u.
4010**3	2,50 m.	x 14		12,45 €/u.	13,88 €/u.	15,53 €/u.
4011**3	3,00 m.	x 14		14,84 €/u.	16,44 €/u.	18,50 €/u.

NOTA: Corte de barra 1 € (Referencia 9999989)

## ACCESORIOS

ANILLA



Ø IN. 29,5  
Ø EX. 38,5

ANILLO SILENCIADOR



Ø31/Ø27  
7

EMPALME (Bicromatado)



120  
Ø18

REF.	4013**2	4013**4	4131**2	4131**4	4032442	4032444
	x 10	x 1	x 10	x 1	x 1	x 1
	x 10		x 10		x 10	
A	7,60 €/bl.	0,72 €/bs.	07 1,94 €/bl.	0,18 €/bs.	2,84 €/bl.	2,68 €/bs.
B	9,29 €/bl.	0,86 €/bs.	20 1,94 €/bl.	0,18 €/bs.	-	-
C	10,92 €/bl.	1,02 €/bs.	-	-	-	-

CODO



320  
Ø20  
140

RECOGE-CORTINAS CURVADO



31  
255  
104

CODO GIRATORIO



28  
Ø48

REF.	4035**0	4098**2	4098**4	4169**2	4169**4
	x 1	x 1	x 1	x 1	x 1
		x 10		x 10	
A	4,74 €/u.	10,56 €/bl.	9,94 €/bs.	4,03 €/bl.	3,78 €/bs.
B	5,24 €/u.	12,05 €/bl.	11,32 €/bs.	4,47 €/bl.	4,20 €/bs.
C	5,51 €/u.	12,33 €/bl.	11,61 €/bs.	4,68 €/bl.	4,40 €/bs.

NOTA: Envasado en bolsa (.4), el pedido mínimo es de 10 unidades. Anillas en bolsa (.4), el pedido mínimo es de 100 unidades.

\*\* Colores A: 07= Negro.

\*\* Colores B: 60= Perla. 63= Óxido. 69= Negro-Dorado.

\*\* Colores C: 06= Blanco. 62= Marfil-Oro.

Código de envasado: 2= Blister. 3= Skin. 4= Bolsa de protección.



# ACCESORIOS

SOPORTE TECHO



SOPORTE "CARACOL"

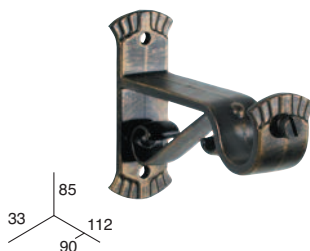

SOPORTE "OLAS" LARGO

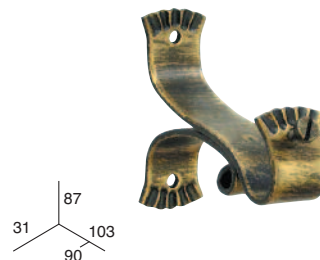

REF.	4027**2	4027**4	4102**2	4102**4	4075**2	4075**4
	x 2	x 1	x 2	x 1	x 2	x 1
	x 10		x 10		x 10	
A	12,23 €/bl.	5,77 €/bs.	13,24 €/bl.	6,22 €/bs.	9,91 €/bl.	4,65 €/bs.
B	12,93 €/bl.	6,08 €/bs.	13,96 €/bl.	6,57 €/bs.	11,36 €/bl.	5,35 €/bs.
C	13,43 €/bl.	6,29 €/bs.	14,52 €/bl.	6,82 €/bs.	12,02 €/bl.	5,65 €/bs.

SOPORTE "OLAS" CORTO



SOPORTE SENCILLO

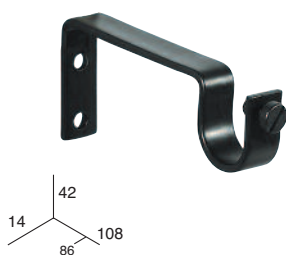

SOPORTE CENTRAL

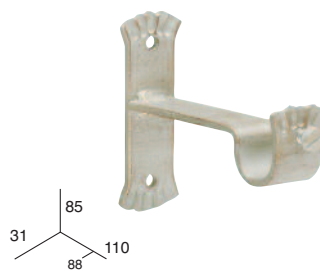

REF.	4076**2	4076**4	4005**2	4005**4	4024**2	4024**4
	x 2	x 1	x 2	x 1	x 2	x 1
	x 10		x 10		x 10	
A	9,91 €/bl.	4,65 €/bs.	7,51 €/bl.	3,54 €/bs.	12,25 €/bl.	5,74 €/bs.
B	11,37 €/bl.	5,33 €/bs.	8,10 €/bl.	3,82 €/bs.	12,92 €/bl.	6,09 €/bs.
C	12,02 €/bl.	5,65 €/bs.	8,33 €/bl.	3,92 €/bs.	13,41 €/bl.	6,30 €/bs.

SOPORTE EXTENSIBLE



SOPORTE DOBLE 20-20 MM.

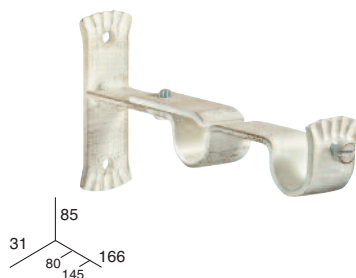

SOPORTE LARGO

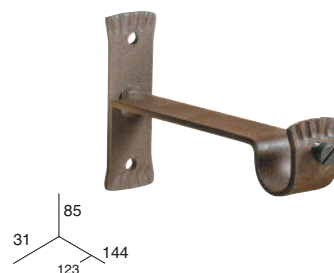

REF.	4033**2	4033**4	4028**2	4028**4	4026**2	4026**4
	x 1	x 1	x 2	x 1	x 2	x 1
	x 10		x 10		x 10	
A	11,42 €/bl.	10,74 €/bs.	18,12 €/bl.	8,53 €/bs.	13,24 €/bl.	6,23 €/bs.
B	12,26 €/bl.	11,54 €/bs.	19,19 €/bl.	9,02 €/bs.	13,85 €/bl.	6,51 €/bs.
C	12,66 €/bl.	11,90 €/bs.	19,84 €/bl.	9,32 €/bs.	14,34 €/bl.	6,77 €/bs.

NOTA: Envasado en bolsa (.4), el pedido mínimo es de 10 unidades. Anillas en bolsa (.4), el pedido mínimo es de 100 unidades.

\*\* Colores A: 07= Negro.  
 \*\* Colores B: 60= Perla. 63= Óxido. 69= Negro-Dorado.  
 \*\* Colores C: 06= Blanco. 62= Marfil-Oro.  
 Código de envasado: 2= Blister. 4= Bolsa de protección.



# ACCESORIOS Y TERMINALES

SOPORTE LATERAL ABIERTO

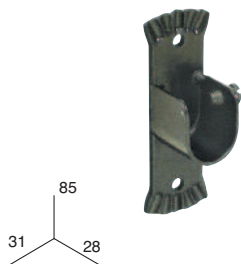

SOPORTE DOBLE TECHO



REF.	4078**2	4078**4	4113**2	4113**4
	x 1 juego	x 1 juego	x 2	x 1
	x 10		x 10	
A	7,59 €/bl.	7,14 €/bs.	19,83 €/bl.	9,30 €/bs.
B	8,66 €/bl.	8,17 €/bs.	21,49 €/bl.	10,10 €/bs.
C	9,47 €/bl.	8,86 €/bs.	22,04 €/bl.	10,37 €/bs.

TERMINAL "TAPÓN"

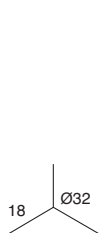

TERMINAL "ESFERA"



TERMINAL "OLIVO"

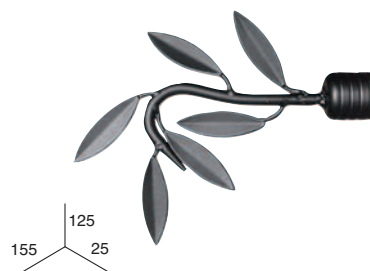

REF.	4068**2	4068**4	4105**2	4105**4	4612**2	4612**4
	x 2	x 1	x 2	x 1	x 1 juego	x 1 juego
	x 10		x 15		x 10	
A	3,62 €/bl.	1,72 €/bs.	11,72 €/bl.	5,50 €/bs.	9,80 €/bl.	9,22 €/bs.
B	4,00 €/bl.	1,88 €/bs.	13,15 €/bl.	6,20 €/bs.	10,54 €/bl.	9,92 €/bs.
C	4,26 €/bl.	2,01 €/bs.	13,51 €/bl.	6,34 €/bs.	11,12 €/bl.	10,45 €/bs.

TERMINAL "HOJAS"

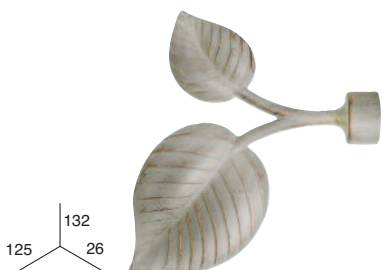

TERMINAL "LIS"

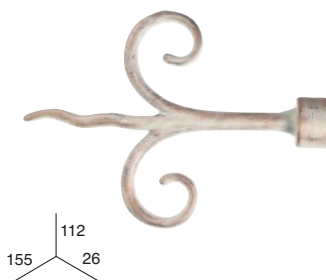

TERMINAL "RAMAS"

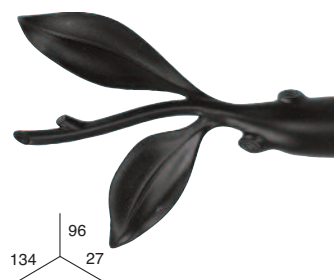

REF.	4002**2	4002**4	4003**2	4003**4	4610**2	4610**4
	x 1 juego	x 1 juego	x 1	x 1	x 1 juego	x 1 juego
	x 10		x 10		x 10	
A	10,86 €/bl.	10,21 €/bs.	5,93 €/bl.	5,59 €/bs.	9,95 €/bl.	9,35 €/bs.
B	11,84 €/bl.	11,13 €/bs.	6,59 €/bl.	6,17 €/bs.	10,93 €/bl.	10,28 €/bs.
C	12,39 €/bl.	11,62 €/bs.	6,63 €/bl.	6,23 €/bs.	11,45 €/bl.	10,75 €/bs.

NOTA: Envasado en bolsa (.4), el pedido mínimo es de 10 unidades. Anillas en bolsa (.4), el pedido mínimo es de 100 unidades.

\*\* Colores A: 07= Negro.  
 \*\* Colores B: 60= Perla. 63= Óxido. 69= Negro-Dorado.  
 \*\* Colores C: 06= Blanco. 62= Marfil-Oro.  
 Código de envasado: 2= Blister. 4= Bolsa de protección.

FORJA Ø20 mm.

# TERMINALES

TERMINAL "AROS"

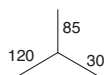

TERMINAL "IBIZA"

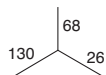

TERMINAL "HERÁLDICO"

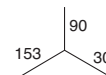

REF.	4134**2	4134**4	4000**2	4000**4	4135**2	4135**4
	x 1	x 1	x 1 juego	x 1 juego	x 1	x 1
	x 10		x 10		x 10	
A	6,29 €/bl.	5,91 €/bs.	9,14 €/bl.	8,60 €/bs.	7,00 €/bl.	6,57 €/bs.
B	6,77 €/bl.	6,36 €/bs.	10,14 €/bl.	9,54 €/bs.	7,50 €/bl.	7,07 €/bs.
C	6,98 €/bl.	6,58 €/bs.	10,63 €/bl.	9,98 €/bs.	7,72 €/bl.	7,25 €/bs.

TERMINAL "PIÑA"

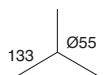

TERMINAL "PARÍS"

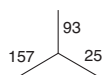

*a extinguir*

REF.	4020**2	4020**4	4019**2	4019**4
	x 1	x 1	x 1	x 1
	x 10		x 10	
A	11,70 €/bl.	10,98 €/bs.	16,87 €/bl.	15,86 €/bs.
B	12,10 €/bl.	11,37 €/bs.	17,37 €/bl.	16,32 €/bs.
C	12,28 €/bl.	11,52 €/bs.	17,56 €/bl.	16,51 €/bs.

**NOTA:** Envasado en bolsa (.4), el pedido mínimo es de 10 unidades. Anillas en bolsa (.4), el pedido mínimo es de 100 unidades.

\*\* Colores **A:** 07= Negro.

\*\* Colores **B:** 60= Perla. 63= Óxido. 69= Negro-Dorado.

\*\* Colores **C:** 06= Blanco. 62= Marfil-Oro.

Código de envasado: 2= Blister. 4= Bolsa de protección.



# SUGERENCIAS DE MONTAJE Ø20 mm.

(Con soporte frente 4024\*\*4 y anillas)

COMPONENTES NECESARIOS			
REF. Tubo Ø20 (Skin)	Anillas 4013**4	Soporte 4024**4	Terminales
4008**3 (1,50 m.)	16 unidades	2 soportes	2 terminales
4009**3 (2,00 m.)	20 unidades	2 soportes	2 terminales
4010**3 (2,50 m.)	26 unidades	3 soportes	2 terminales
4011**3 (3,00 m.)	30 unidades	3 soportes	2 terminales

TERMINAL "AROS"

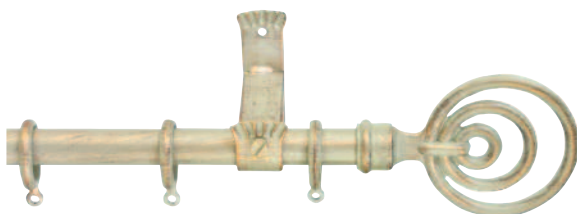

<---->	A	B	C
(1,50 m.)	42,50 €	47,22 €	51,63 €
(2,00 m.)	53,50 €	59,36 €	64,96 €
(2,50 m.)	60,21 €	67,23 €	74,11 €
(3,00 m.)	65,48 €	73,23 €	81,16 €

TERMINAL "PARÍS"

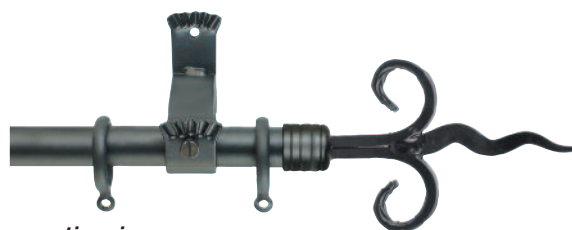

a extinguir

<---->	A	B	C
(1,50 m.)	62,40 €	67,14 €	71,49 €
(2,00 m.)	73,40 €	79,28 €	84,82 €
(2,50 m.)	80,11 €	87,15 €	93,97 €
(3,00 m.)	85,38 €	93,15 €	101,02 €

TERMINAL "ESFERA"

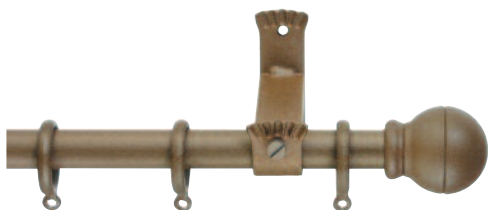

<---->	A	B	C
(1,50 m.)	41,68 €	46,90 €	51,15 €
(2,00 m.)	52,68 €	59,04 €	64,48 €
(2,50 m.)	59,39 €	66,91 €	73,63 €
(3,00 m.)	64,66 €	72,91 €	80,68 €

TERMINAL "HERÁLDICO"



<---->	A	B	C
(1,50 m.)	43,82 €	48,64 €	52,97 €
(2,00 m.)	54,82 €	60,78 €	66,30 €
(2,50 m.)	61,53 €	68,65 €	75,45 €
(3,00 m.)	66,80 €	74,65 €	82,50 €

TERMINAL "HOJAS"

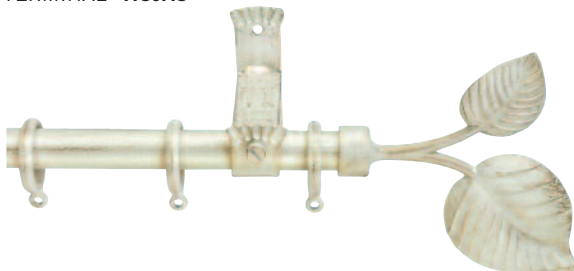

<---->	A	B	C
(1,50 m.)	40,89 €	45,63 €	50,09 €
(2,00 m.)	51,89 €	57,77 €	63,42 €
(2,50 m.)	58,60 €	65,64 €	72,57 €
(3,00 m.)	63,87 €	71,64 €	79,62 €

TERMINAL "LIS"



<---->	A	B	C
(1,50 m.)	41,86 €	46,84 €	50,93 €
(2,00 m.)	52,86 €	58,98 €	64,26 €
(2,50 m.)	59,57 €	66,85 €	73,41 €
(3,00 m.)	64,84 €	72,85 €	80,46 €

\*\* Colores A: 07= Negro.  
 \*\* Colores B: 60= Perla. 63= Óxido. 69= Negro-Dorado.  
 \*\* Colores C: 06= Blanco. 62= Marfil-Oro.

# SUGERENCIAS DE MONTAJE Ø20 mm.

(Con soporte frente 4024\*\*4 y anillas)

## COMPONENTES NECESARIOS

REF. Tubo Ø20 (Skin)	Anillas 4013**4	Soporte 4024**4	Terminales
4008**3 (1,50 m.)	16 unidades	2 soportes	2 terminales
4009**3 (2,00 m.)	20 unidades	2 soportes	2 terminales
4010**3 (2,50 m.)	26 unidades	3 soportes	2 terminales
4011**3 (3,00 m.)	30 unidades	3 soportes	2 terminales

TERMINAL "IBIZA"

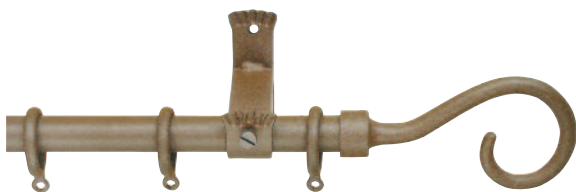

<---->	A	B	C
(1,50 m.)	39,28 €	44,04 €	48,45 €
(2,00 m.)	50,28 €	56,18 €	61,78 €
(2,50 m.)	56,99 €	64,05 €	70,93 €
(3,00 m.)	62,26 €	70,05 €	77,98 €

TERMINAL "PIÑA"



<---->	A	B	C
(1,50 m.)	52,64 €	57,24 €	61,51 €
(2,00 m.)	63,64 €	69,38 €	74,84 €
(2,50 m.)	70,35 €	77,25 €	83,99 €
(3,00 m.)	75,62 €	83,25 €	91,04 €

TERMINAL "OLIVO"



<---->	A	B	C
(1,50 m.)	39,90 €	44,42 €	48,92 €
(2,00 m.)	50,90 €	56,56 €	62,25 €
(2,50 m.)	57,61 €	64,43 €	71,40 €
(3,00 m.)	62,88 €	70,43 €	78,45 €

TERMINAL "RAMAS"

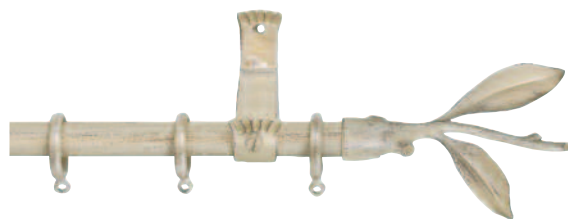

<---->	A	B	C
(1,50 m.)	40,03 €	44,78 €	49,22 €
(2,00 m.)	51,03 €	56,92 €	62,55 €
(2,50 m.)	57,74 €	64,79 €	71,70 €
(3,00 m.)	63,01 €	70,79 €	78,75 €

\*\* Colores A: 07= Negro.

\*\* Colores B: 60= Perla. 63= Óxido. 69= Negro-Dorado.

\*\* Colores C: 06= Blanco. 62= Marfil-Oro.

# SUGERENCIAS DE MONTAJE Ø20 mm.

## Riel doble 20-20 mm.

(Con soporte doble 4028\*\*4, terminal posterior tapón 4068\*\*4 y anillas)

COMPONENTES NECESARIOS			
REF. Tubo Ø20+Ø20 (Skin)	Anillas 4013**4	Soporte 4028**4	Terminales
4008**3 + 4008**3 (1,50 m.)	32 unidades	2 soportes	2 + 2 terminales
4009**3 + 4009**3 (2,00 m.)	40 unidades	2 soportes	2 + 2 terminales
4010**3 + 4010**3 (2,50 m.)	52 unidades	3 soportes	2 + 2 terminales
4011**3 + 4011**3 (3,00 m.)	60 unidades	3 soportes	2 + 2 terminales

TERMINAL "AROS"



<---->	A	B	C
(1,50 m.)	70,72 €	79,16 €	87,56 €
(2,00 m.)	81,24 €	91,26 €	101,62 €
(2,50 m.)	103,19 €	116,02 €	129,24 €
(3,00 m.)	113,73 €	128,02 €	143,34 €

TERMINAL "PARÍS"

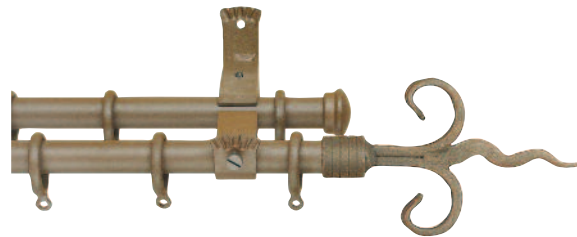

a extinguir

<---->	A	B	C
(1,50 m.)	90,62 €	99,08 €	107,42 €
(2,00 m.)	101,14 €	111,18 €	121,48 €
(2,50 m.)	123,09 €	135,94 €	149,10 €
(3,00 m.)	133,63 €	147,94 €	163,20 €

TERMINAL "ESFERA"

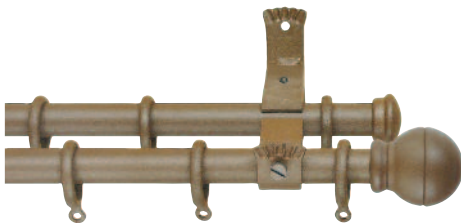

<---->	A	B	C
(1,50 m.)	69,90 €	78,84 €	87,08 €
(2,00 m.)	80,42 €	90,94 €	101,14 €
(2,50 m.)	102,37 €	115,70 €	128,76 €
(3,00 m.)	112,91 €	127,70 €	142,86 €

TERMINAL "HERÁLDICO"

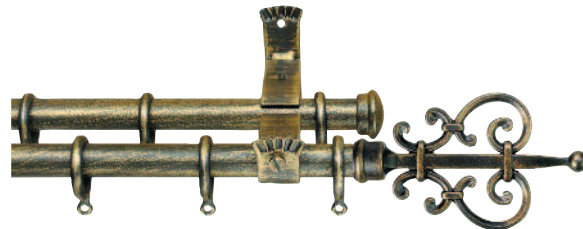

<---->	A	B	C
(1,50 m.)	72,04 €	80,58 €	88,90 €
(2,00 m.)	82,56 €	92,68 €	102,96 €
(2,50 m.)	104,51 €	117,44 €	130,58 €
(3,00 m.)	115,05 €	129,44 €	144,68 €

TERMINAL "HOJAS"

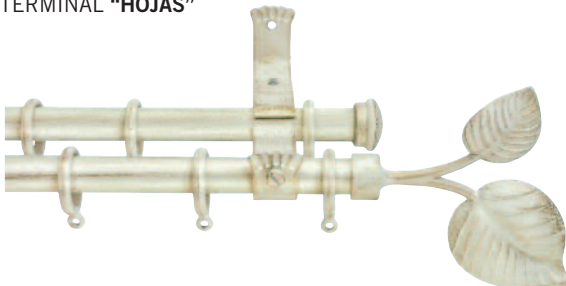

<---->	A	B	C
(1,50 m.)	69,11 €	77,57 €	86,02 €
(2,00 m.)	79,63 €	89,67 €	100,08 €
(2,50 m.)	101,58 €	114,43 €	127,70 €
(3,00 m.)	112,12 €	126,43 €	141,80 €

TERMINAL "LIS"



<---->	A	B	C
(1,50 m.)	70,08 €	78,78 €	86,86 €
(2,00 m.)	80,60 €	90,88 €	100,92 €
(2,50 m.)	102,55 €	115,64 €	128,54 €
(3,00 m.)	113,09 €	127,64 €	142,64 €

\*\* Colores A: 07= Negro.  
 \*\* Colores B: 60= Perla. 63= Óxido. 69= Negro-Dorado.  
 \*\* Colores C: 06= Blanco. 62= Marfil-Oro.

# SUGERENCIAS DE MONTAJE Ø20 mm.

## Riel doble 20-20 mm.

(Con soporte doble 4028\*\*4, terminal posterior tapón 4068\*\*4 y anillas)

### COMPONENTES NECESARIOS

REF. Tubo Ø20+Ø20 (Skin)	Anillas 4013**4	Soporte 4028**4	Terminales
4008**3 + 4008**3 (1,50 m.)	32 unidades	2 soportes	2 + 2 terminales
4009**3 + 4009**3 (2,00 m.)	40 unidades	2 soportes	2 + 2 terminales
4010**3 + 4010**3 (2,50 m.)	52 unidades	3 soportes	2 + 2 terminales
4011**3 + 4011**3 (3,00 m.)	60 unidades	3 soportes	2 + 2 terminales

TERMINAL "IBIZA"

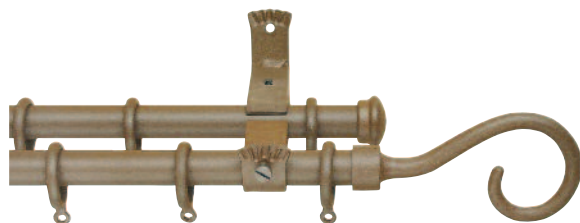

<---->	A	B	C
(1,50 m.)	67,50 €	75,98 €	84,38 €
(2,00 m.)	78,02 €	88,08 €	98,44 €
(2,50 m.)	99,97 €	112,84 €	126,06 €
(3,00 m.)	110,51 €	124,84 €	140,16 €

TERMINAL "PIÑA"

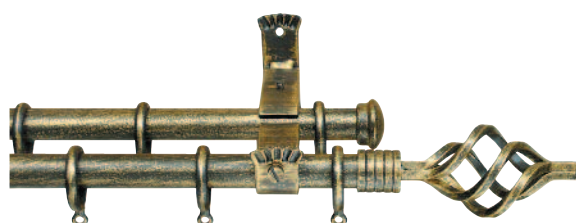

<---->	A	B	C
(1,50 m.)	80,86 €	89,18 €	97,44 €
(2,00 m.)	91,38 €	101,28 €	111,50 €
(2,50 m.)	113,33 €	126,04 €	139,12 €
(3,00 m.)	123,87 €	138,04 €	153,22 €

TERMINAL "OLIVO"

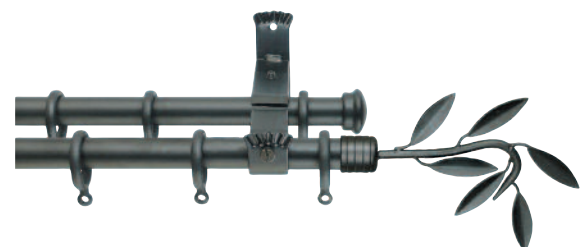

<---->	A	B	C
(1,50 m.)	68,12 €	76,36 €	84,85 €
(2,00 m.)	78,64 €	88,46 €	98,91 €
(2,50 m.)	100,59 €	113,22 €	126,53 €
(3,00 m.)	111,13 €	125,22 €	140,63 €

TERMINAL "RAMAS"

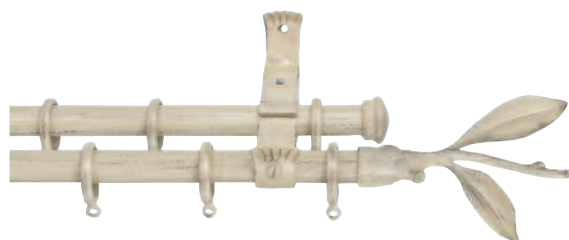

<---->	A	B	C
(1,50 m.)	68,25 €	76,72 €	85,15 €
(2,00 m.)	78,77 €	88,82 €	99,21 €
(2,50 m.)	100,72 €	113,58 €	126,83 €
(3,00 m.)	111,26 €	125,58 €	140,93 €

\*\* Colores A: 07= Negro.

\*\* Colores B: 60= Perla. 63= Óxido. 69= Negro-Dorado.

\*\* Colores C: 06= Blanco. 62= Marfil-Oro.



## COLORES

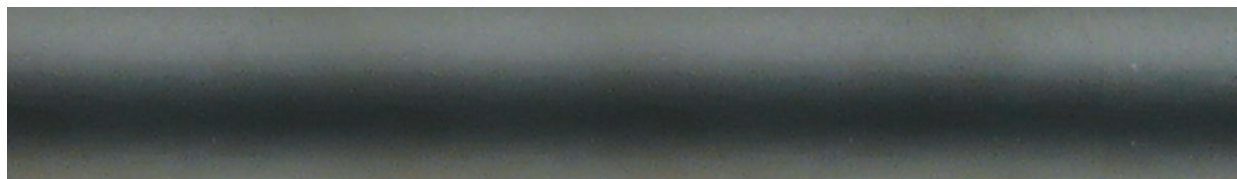

07. NEGRO

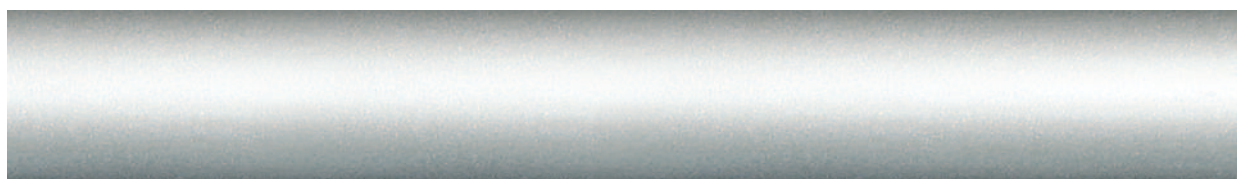

60. PERLA (Contrapedido)



62. MARFIL-ORO



63. ÓXIDO



69. NEGRO-DORADO



# TUBO FORJA Ø12 mm.



REFERENCIA	←----→			COLORES A	COLORES B	COLORES C
4127**3	1,00 m.	x 12		3,88 €/u.	4,44 €/u.	5,02 €/u.
4128**3	1,50 m.	x 12		5,74 €/u.	6,57 €/u.	7,25 €/u.
4129**3	2,00 m.	x 12		7,66 €/u.	8,85 €/u.	9,68 €/u.
4130**3	2,50 m.	x 12		9,79 €/u.	11,25 €/u.	12,37 €/u.

NOTA: Corte de barra 1 € (Referencia 9999989)

## ACCESORIOS

ANILLA



Ø IN. 21,5  
Ø EX. 29

SOPORTE CENTRAL

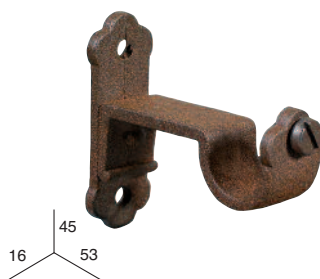

45  
16 53

TERMINAL "ESFERA"



Ø24 30

REF.	4126**2	4109**2	4132**2
	x 10	x 2	x 2
	x 10	x 10	x 10
A	5,50 €/bl.	4,87 €/bl.	4,61 €/bl.
B	6,94 €/bl.	5,33 €/bl.	5,08 €/bl.
C	8,07 €/bl.	5,55 €/bl.	5,29 €/bl.

TERMINAL "ONDAS"



25  
19 49

TERMINAL "LIS"

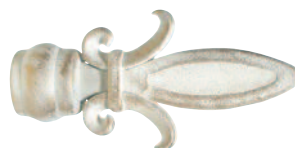

34  
22 69

TERMINAL TAPÓN



Ø23 13

REF.	4112**2	4110**2	4364**2
	x 2	x 2	x 2
	x 10	x 10	x 10
A	4,16 €/bl.	3,98 €/bl.	3,15 €/bl.
B	4,63 €/bl.	4,41 €/bl.	3,62 €/bl.
C	4,80 €/bl.	4,57 €/bl.	3,77 €/bl.

\*\* Colores A: 07= Negro.  
\*\* Colores B: 60= Perla. 63= Óxido. 69= Negro-Dorado.  
\*\* Colores C: 62= Marfil-Oro.

Código de envasado: 2= Blister. 3= Skin.



# ACCESORIOS COMUNES

ACCESORIO SOPORTE EXTENSIBLE  
20-20 Y 28-20 mm.



CRUZ PARA ROSCAR



LAZO



REF.	4168**2	4168**4	4066**2	4066**4	4039**2	4039**4
	x 1	x 1	x 2	x 1	x 2	x 1
	x 10		x 10		x 10	
A	6,59 €/bl.	6,20 €/bs.	7,43 €/bl.	3,48 €/bs.	3,27 €/bl.	1,54 €/bs.
B	7,00 €/bl.	6,57 €/bs.	8,04 €/bl.	3,78 €/bs.	3,64 €/bl.	1,73 €/bs.
C	7,12 €/bl.	6,68 €/bs.	8,54 €/bl.	4,02 €/bs.	4,14 €/bl.	1,94 €/bs.

ALCAYATA ESFERA, 8 cm.



RECOGE-CORTINAS 10 cm.



RECOGE-CORTINAS 15 cm.



REF.	4103**2	4103**4	4064**2	4064**4	4065**2	4065**4
	x 2	x 1	x 1	x 1	x 1	x 1
	x 10		x 10		x 10	
A	4,48 €/bl.	2,10 €/bs.	9,63 €/bl.	9,04 €/bs.	10,01 €/bl.	9,41 €/bs.
B	5,53 €/bl.	2,59 €/bs.	9,95 €/bl.	9,38 €/bs.	10,35 €/bl.	9,70 €/bs.
C	5,84 €/bl.	2,73 €/bs.	10,17 €/bl.	9,56 €/bs.	10,44 €/bl.	9,81 €/bs.

# ANILLAS DECORATIVAS

ANILLA 20 mm. CON SOL

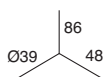

HASTA FIN DE EXISTENCIAS

ANILLA 20 mm. CON LUNA

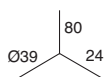

HASTA FIN DE EXISTENCIAS

ANILLA 20 mm. CON HOJA

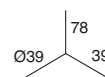

HASTA FIN DE EXISTENCIAS

REF.	4390**5	4391**5	4392**5
	x 10	x 10	x 10
	x 50		x 50
A	9,31 €/bs.	9,31 €/bs.	9,31 €/bs.
B	10,38 €/bs.	10,38 €/bs.	10,38 €/bs.
C	9,83 €/bs.	9,83 €/bs.	9,83 €/bs.

\*\* Colores A: 07= Negro.

\*\* Colores B: 60= Perla. 63= Óxido. 69= Negro-Dorado.





\*\* Colores C: 06= Blanco. 62= Marfil-Oro.

Código de envasado: 2= Blister. 4= Bolsa de protección. 5= Bolsa con cartón.

## ACCESORIOS COMUNES





TIRADOR 0,75 m. CON MOSQUETÓN



REF.	4036**5	4036**2
	 x 1	 x 1
	x 30	x 30
		
 A	14,25 €/bs.	15,31 €/bl.
B	14,96 €/bs.	16,25 €/bl.
C	15,68 €/bs.	17,05 €/bl.

TIRADOR 1,00 m. CON MOSQUETÓN



REF.	4037**5	4037**2
	 x 1	 x 1
	x 30	x 30
		
 A	14,55 €/bs.	15,76 €/bl.
B	15,32 €/bs.	16,74 €/bl.
C	16,04 €/bs.	17,53 €/bl.

\*\* Colores **A**: 07= Negro.  
 \*\* Colores **B**: 60= Perla. 63= Óxido. 69= Negro-Dorado.  
 \*\* Colores **C**: 06= Blanco. 62= Marfil-Oro.  
 Código de envasado: 2= Blister. 5= Bolsa con cartón.





СНУС



# M a d e r a





## COLORES



**00.**  
NATURAL

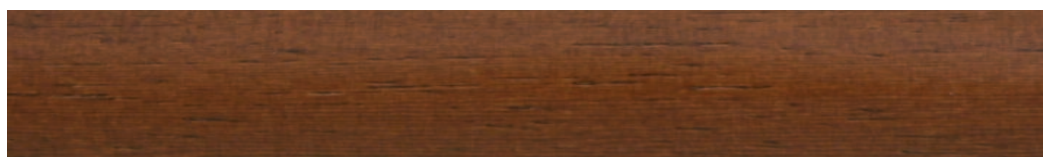

**01.**  
NOGAL



**02.**  
PINO



**03.**  
TECA



**04.**  
ROBLE

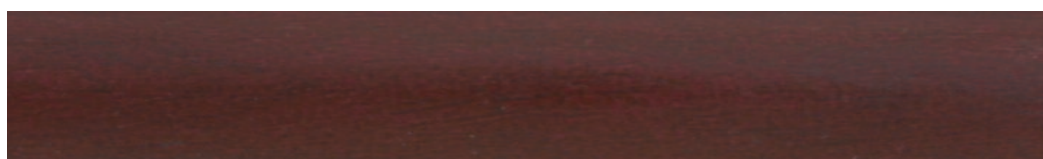

**05.**  
CORINTO



**09.**  
CAOBA



**10.**  
WENGUÉ



# BARRA DE MADERA LISA



	←----→			A	B
1730**4	1,80 m.	x 6		28,60 €/u.	28,03 €/u.
1731**4	2,10 m.	x 6		33,09 €/u.	32,43 €/u.
1749**4	2,40 m.	x 6		37,72 €/u.	36,96 €/u.
1732**4	3,00 m.	x 6		46,81 €/u.	45,87 €/u.
1759**4	3,60 m.	x 6		56,24 €/u.	55,11 €/u.



## ACCESORIOS

ANILLA PULIMENTADA



Ø IN. 68  
Ø EX. 93

ANILLA OVAL PULIMENTADA



Ø IN. 63  
Ø EX. 95

ANILLA ESTRIADA PULIMENTADA



Ø IN. 62  
Ø EX. 95

REF.	1812**0	1729**0	1746**0
	x 120	x 120	x 120
	A: 0,99 €/u. B: 0,97 €/u.	A: 1,99 €/u. B: 1,94 €/u.	A: 1,99 €/u. B: 1,94 €/u.

SOPORTE ABIERTO "P"

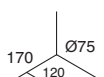

SOPORTE ABIERTO "G"

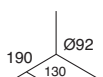

SOPORTE LATERAL



REF.	1790**0	1791**0	1796**0
	x 12	x 12	x 36
	A: 8,83 €/u. B: 8,66 €/u.	A: 14,82 €/u. B: 14,52 €/u.	A: 6,00 €/u. B: 5,88 €/u.

\*\* Colores A: 01= Nogal. 02= Pino. 03= Teca. 04= Roble. 05= Corinto. 09= Caoba. 10= Wengué.  
\*\* Colores B: 00= Natural.  
Código de envasado: 0= Granel. 4= Bolsa de protección.

# ACCESORIOS Y TERMINALES

SOPORTE EXTENSIBLE



REF. 3381+3380

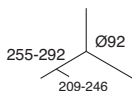

ACCESORIO SOPORTE EXTENSIBLE 50-35  
(para utilizar con soporte 3381\*\*0)



TERMINAL ESFERA "P"

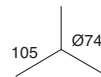

REF.	3381**0	3380**0	1750**0
------	---------	---------	---------



x 12

x 12

x 12



A 15,12 €/u.  
B 14,82 €/u.

3,80 €/u.  
3,71 €/u.

5,12 €/u.  
5,01 €/u.

TERMINAL ESFERA "G"

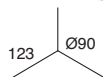

TERMINAL "BELLOTA"

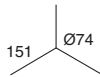

TERMINAL "COPA"

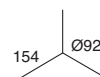

REF.	1786**0	1789**0	1787**0
------	---------	---------	---------



x 12

x 12

x 12



A 9,69 €/u.  
B 9,50 €/u.

6,18 €/u.  
6,05 €/u.

11,03 €/u.  
10,80 €/u.

TERMINAL "MOSCÚ"

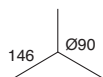

TERMINAL "REY"

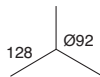

TERMINAL "DOMO"

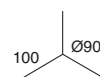

REF.	1788**0	1713**0	1708**0
------	---------	---------	---------



x 12

x 12

x 12



A 10,61 €/u.  
B 10,40 €/u.

9,72 €/u.  
9,52 €/u.

9,22 €/u.  
9,04 €/u.

\*\* Colores A: 01= Nogal. 02= Pino. 03= Teca. 04= Roble. 05= Corinto. 09= Caoba. 10= Wengué.  
\*\* Colores B: 00= Natural.  
Código de envasado: 0= Granel.



## COLORES ESPECIALES DE BASE

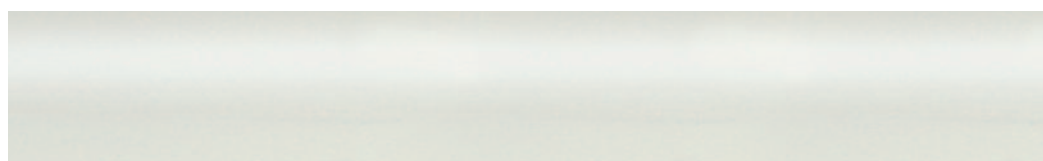

**06.**  
BLANCO

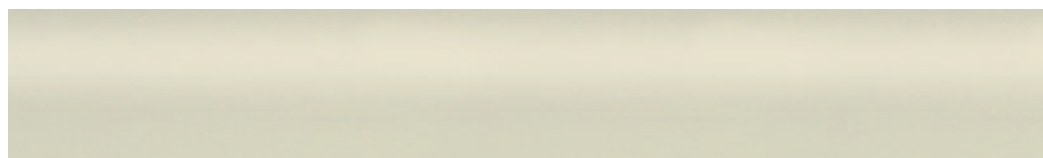

**79.**  
CREMA

## COLORES ESPECIALES PATINADOS



**88.**  
BLANCO  
DORADO



**89.**  
BLANCO  
PLATA



**69.**  
WENGUÉ  
DORADO



**73.**  
WENGUÉ  
PLATA

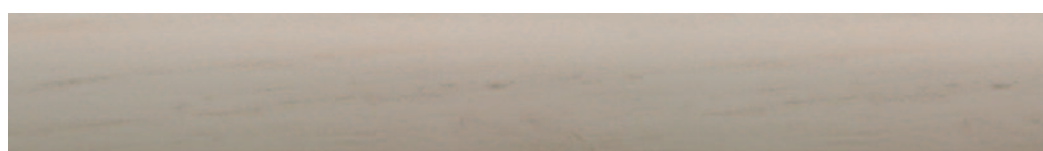

**62.**  
CREMA  
DORADO



**87.**  
CREMA  
PLATA

MADERA Ø50 mm.

\*\* Colores A: 06= Blanco. 79= Crema.

\*\* Colores B: 88= Blanco-Dorado. 89= Blanco-Plata. 69= Wengué-Dorado. 73= Wengué-Plata. 62= Crema-Dorado. 87= Crema-Plata.  
Código de envasado: 4= Bolsa de protección.

# BARRA LISA Y ACCESORIOS

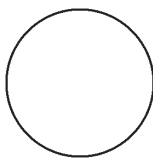

REFERENCIA	←----→			COLORES A	COLORES B
1730**4	1,80 m.	x 6		32,89 €/u.	35,75 €/u.
1749**4	2,40 m.	x 6		43,37 €/u.	47,14 €/u.
1732**4	3,00 m.	x 6		53,83 €/u.	58,51 €/u.

ANILLA LACADA O PULIMENTADA

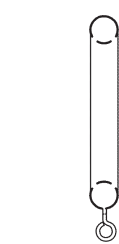

Ø IN. 68  
Ø EX. 93

— Lacada — Pulimentadas —

SOPORTE ABIERTO "G"

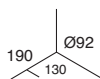

SOPORTE ABIERTO "P"



REF.	1813**0	1812690	1812730	1791**0	1790**0
	x 120	x 120	x 120	x 12	x 12
A	1,41 €/u.			17,04 €/u.	10,15 €/u.
B	1,56 €/u.	1,23 €/u.	1,23 €/u.	18,53 €/u.	11,04 €/u.

SOPORTE LATERAL



REF.	1796**0
	x 36
A	6,90 €/u.
B	7,50 €/u.

\*\* Colores A: 06= Blanco. 79= Crema.

\*\* Colores B: 88= Blanco-Dorado. 89= Blanco-Plata. 69= Wengué-Dorado. 73= Wengué-Plata. 62= Crema-Dorado. 87= Crema-Plata.  
Código de envasado: 0= Granel. 4= Bolsa de protección.





# TERMINALES

TERMINAL ESFERA "G"

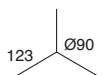

TERMINAL ESFERA "P"

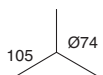

TERMINAL "DOMO"

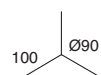

REF. 1786\*\*0



x 12

REF. 1750\*\*0

x 12

REF. 1708\*\*0

x 12



A 11,16 €/u.  
B 12,12 €/u.

A 5,88 €/u.  
B 6,39 €/u.

A 10,60 €/u.  
B 11,53 €/u.

TERMINAL "MOSCÚ"

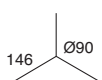

TERMINAL "COPA"

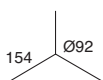

TERMINAL "BELLOTA"

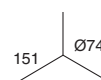

REF. 1788\*\*0



x 12

REF. 1787\*\*0

x 12

REF. 1789\*\*0

x 12



A 12,20 €/u.  
B 13,26 €/u.

A 12,67 €/u.  
B 13,78 €/u.

A 7,10 €/u.  
B 7,72 €/u.

\*\* Colores A: 06= Blanco. 79= Crema.

\*\* Colores B: 88= Blanco-Dorado. 89= Blanco-Plata. 69= Wengué-Dorado. 73= Wengué-Plata. 62= Crema-Dorado. 87= Crema-Plata.  
Código de envasado: 0= Granel.



## COLORES

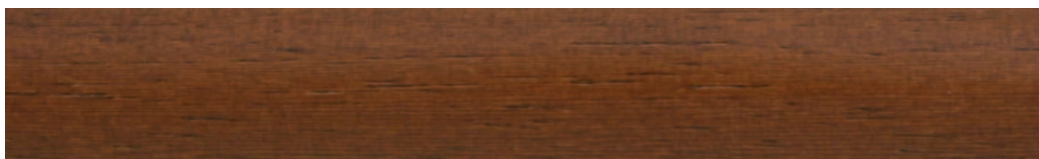

**01.**  
NOGAL



**02.**  
PINO



**03.**  
TECA



**04.**  
ROBLE

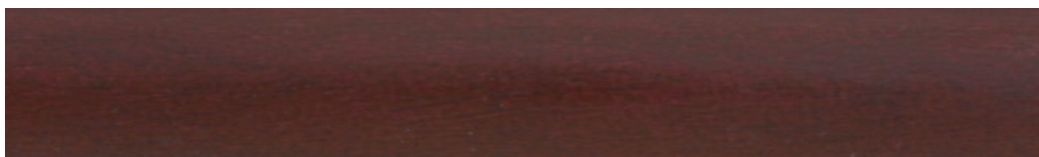

**05.**  
CORINTO



**06.**  
BLANCO

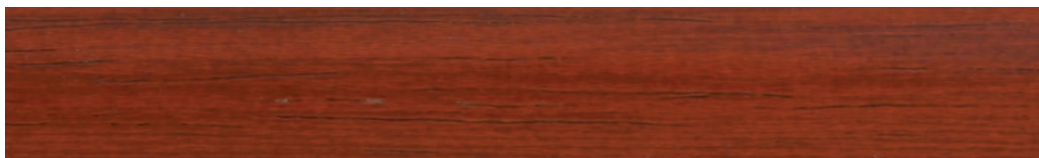

**09.**  
CAOBA



**10.**  
WENGUÉ

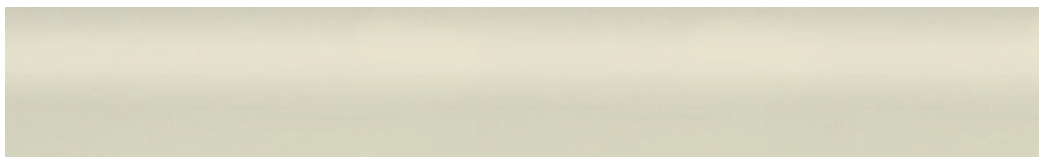

**79.**  
CREMA

**NOTA:** Disponemos de colores patinados bajo pedido, consultar.



## RIEL DE MADERA LACADO: (Con anillas y terminales "Chyc")

BARRA DE MADERA "EXTRA"

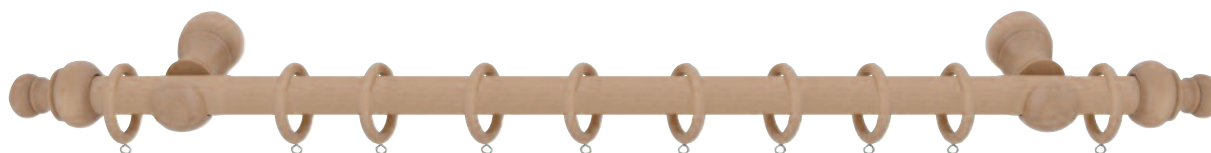

REF.	<---->		A	B
0794**4	1,50 m.	x 4	37,43 €/u.	43,04 €/u.
0763**4	1,80 m.	x 4	40,81 €/u.	46,93 €/u.
0764**4	2,10 m.	x 4	45,17 €/u.	51,94 €/u.
0765**4	2,40 m.	x 4	53,35 €/u.	61,35 €/u.
0767**4	3,00 m.	x 4	60,95 €/u.	66,89 €/u.
0769**4	3,60 m. <small>(2 barras de 1,80 m.)</small>	x 4	68,61 €/u.	78,90 €/u.

REF.	<---->		A	B
0794**2	1,50 m.	x 6	50,73 €/u.	58,33 €/u.
0763**2	1,80 m.	x 6	55,80 €/u.	64,17 €/u.
0764**2	2,10 m.	x 6	61,78 €/u.	71,04 €/u.
0765**2	2,40 m.	x 6	72,88 €/u.	83,81 €/u.
0885**2	3,00 m. <small>(2 barras de 1,50 m.)</small>	x 6	79,15 €/u.	91,02 €/u.
0769**2	3,60 m. <small>(2 barras de 1,80 m.)</small>	x 6	89,51 €/u.	102,94 €/u.

NOTA: a partir de 2,40 m. inclusive, los rieles llevan 3 soportes.

## RIEL DE MADERA LACADO: (Con anillas y terminales "Lisboa")

BARRA DE MADERA "EXTRA"



REF.	<---->		A
2274**4	1,50 m.	x 4	34,72 €/u.
2275**4	1,80 m.	x 4	37,06 €/u.
2276**4	2,10 m.	x 4	41,27 €/u.
2277**4	2,40 m.	x 4	48,09 €/u.
2278**4	3,00 m.	x 4	55,39 €/u.
2279**4	3,60 m. <small>(2 barras de 1,80 m.)</small>	x 4	63,17 €/u.



NOTA: a partir de 2,40 m. inclusive, los rieles llevan 3 soportes.

## BARRA DE MADERA LISA



	<---->		A	B
1760**3	1,50 m.	x 12	12,22 €/u.	14,06 €/u.
1761**3	1,80 m.	x 12	14,53 €/u.	16,71 €/u.
1762**3	2,10 m.	x 12	16,95 €/u.	19,49 €/u.
1763**3	2,40 m.	x 12	19,35 €/u.	22,25 €/u.
1764**3	2,70 m.	x 12	21,72 €/u.	24,96 €/u.
1765**3	3,00 m.	x 12	24,15 €/u.	27,76 €/u.

MADERA "EXTRA"



\*\* Colores A: 01= Nogal. 02= Pino. 03= Teca. 04= Roble. 05= Corinto. 09= Caoba. 10= Wengué.

\*\* Colores B: 06= Blanco. 79= Crema. (sobre pedido)

Código de envasado: 2= Blister. 3= Skin. 4= Bolsa de protección.

# ACCESORIOS Y ANILLAS

ANILLA CON HEMBRILLA

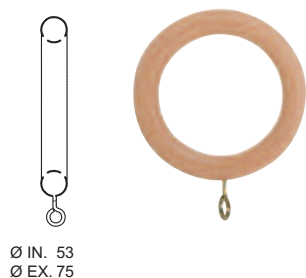

Ø IN. 53  
Ø EX. 75

ANILLA CON HEMBRILLA

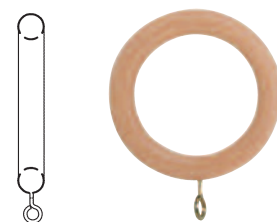

Ø IN. 50  
Ø EX. 70

ANILLA SIN HEMBRILLA

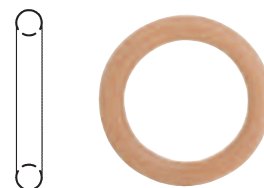

Ø IN. 53  
Ø EX. 75

REF.	0302**0	0304**0	0878**2	0879**2	0046**0
	x 275	x 275	x 10	x 10	x 275
A	0,54 €/u.	-	7,43 €/bl.	-	0,51 €/u.
B	-	0,77 €/u.	-	9,08 €/bl.	-

ANILLA "LISBOA"

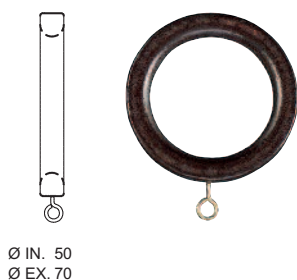

Ø IN. 50  
Ø EX. 70

SOPORTE ABIERTO

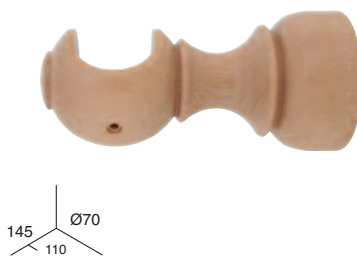

145  
110  
Ø70

SOPORTE ABIERTO DOBLE 35-20

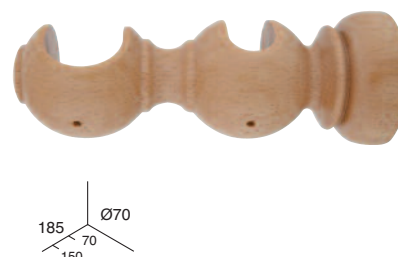

185  
150  
70  
Ø70

REF.	1931**0	0175**0	0175**2	1453**0
	x 275	x 50	x 2	x 25
A	0,53 €/u.	4,80 €/u.	11,89 €/bl.	7,18 €/u.
B	0,58 €/u.	5,29 €/u.	13,07 €/bl.	7,90 €/u.

SOPORTE ABIERTO DOBLE 35-35

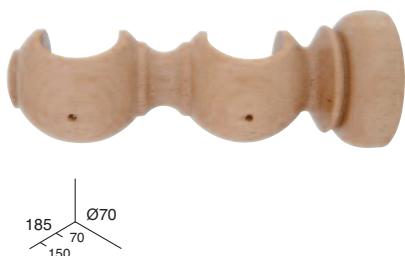

185  
150  
70  
Ø70

SOPORTE ABIERTO "LISBOA"

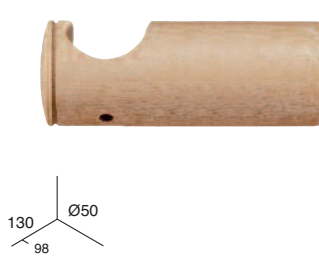

130  
98  
Ø50

SOPORTE ABIERTO DOBLE 35-35 "LISBOA"

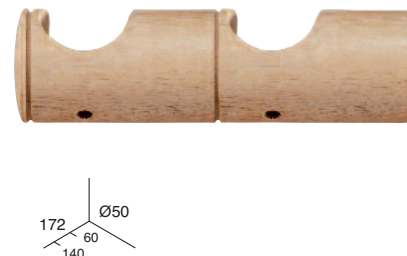

172  
140  
60  
Ø50

REF.	1452**0	1452**2	1604**0	1604**2	0300**0	0300**2
	x 25	x 1	x 50	x 1	x 25	x 1
A	6,92 €/u.	9,22 €/bl.	3,60 €/u.	8,53 €/bl.	4,22 €/u.	6,22 €/bl.
B	7,60 €/u.	10,14 €/bl.	3,95 €/u.	9,38 €/bl.	4,64 €/u.	6,84 €/bl.

\*\* Colores A: 01= Nogal. 02= Pino. 03= Teca. 04= Roble. 05= Corinto. 09= Caoba. 10= Wengué.  
\*\* Colores B: 06= Blanco. 79= Crema. (sobre pedido)  
Código de envasado: 0= Granel. 2= Blister.



# ACCESORIOS

SOPORTE PARED ESQUINA

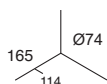

SOPORTE LATERAL

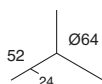

SOPORTE LATERAL "LISBOA"

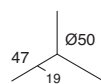

REF.	0295**0	0295**2	1499**0	1499**2	0306**0	0306**2
	x 25	x 1	x 25	x 2	x 25	x 2
A	6,52 €/u.	8,90 €/bl.	2,45 €/u.	7,40 €/bl.	2,05 €/u.	5,24 €/bl.
B	7,17 €/u.	9,80 €/bl.	2,70 €/u.	8,15 €/bl.	2,25 €/u.	5,76 €/bl.

SOPORTE TECHO "LISBOA"

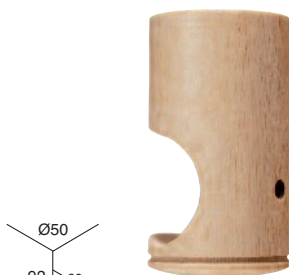

SOPORTE TECHO



SOPORTE TECHO ESQUINA

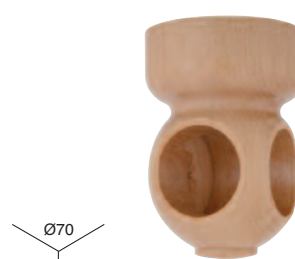

REF.	0307**0	0307**2	0564**0	0564**2	0294**0	0294**2
	x 50	x 1	x 50	x 2	x 50	x 1
A	3,27 €/u.	8,27 €/bl.	4,09 €/u.	10,22 €/bl.	4,07 €/u.	6,39 €/bl.
B	3,61 €/u.	9,10 €/bl.	4,49 €/u.	11,24 €/bl.	4,48 €/u.	7,04 €/bl.

ACCESORIO SOPORTE EXTENSIBLE 35-20  
(para utilizar con soporte 0183\*\*0/0183\*\*2)



SOPORTE EXTENSIBLE

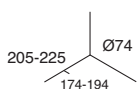

REF. 0183+0535



REF.	0535**0	0183**0	0183**2
	x 25	x 25	x 1
A	2,11 €/u.	5,86 €/u.	8,36 €/bl.
B	2,32 €/u.	6,45 €/u.	9,20 €/bl.

\*\* Colores A: 01= Nogal. 02= Pino. 03= Teca. 04= Roble. 05= Corinto. 09= Caoba. 10= Wengué.  
 \*\* Colores B: 06= Blanco. 79= Crema. (sobre pedido)  
 Código de envasado: 0= Granel. 2= Blister.

# TERMINALES

TERMINAL "CHYC"

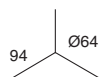

TERMINAL "MOTRIL"

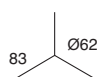

TERMINAL "NERJA"

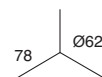

REF.	0177**0	0177**2	0163**0	0163**2	0162**0	0162**2
	x 50	x 2	x 50	x 2	x 50	x 2
A	2,84 €/u.	7,98 €/bl.	2,55 €/u.	6,38 €/bl.	2,51 €/u.	6,24 €/bl.
B	3,12 €/u.	8,78 €/bl.	2,81 €/u.	7,02 €/bl.	2,76 €/u.	6,86 €/bl.

TERMINAL "LISBOA"

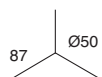

TERMINAL "ESFERA"

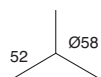

TERMINAL "ESFERA" CON BOTÓN

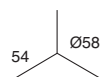
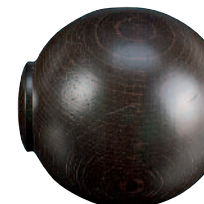

REF.	1613**0	1613**2	1476**0	1476**2	1468**0	1468**2
	x 50	x 2	x 50	x 2	x 50	x 2
A	1,95 €/u.	6,04 €/bl.	1,89 €/u.	6,21 €/bl.	1,89 €/u.	6,35 €/bl.
B	2,15 €/u.	6,64 €/bl.	2,08 €/u.	6,83 €/bl.	2,08 €/u.	6,99 €/bl.

TERMINAL "ESPECIAL"

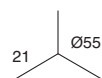

TERMINAL "ALMERÍA"

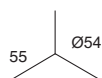

REF.	1485**0	1485**2	1776**0
	x 50	x 2	x 50
A	1,25 €/u.	5,02 €/bl.	1,25 €/u.
B	1,38 €/u.	5,52 €/bl.	

\*\* Colores A: 01= Nogal. 02= Pino. 03= Teca. 04= Roble. 05= Corinto. 09= Caoba. 10= Wengué.  
 \*\* Colores B: 06= Blanco. 79= Crema. (sobre pedido)  
 Código de envasado: 0= Granel. 2= Blister.



## COLORES

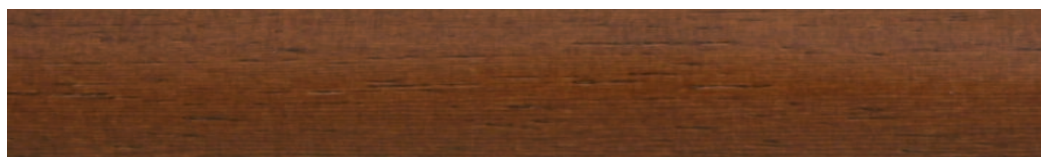

**01.**  
NOGAL



**02.**  
PINO



**03.**  
TECA



**04.**  
ROBLE

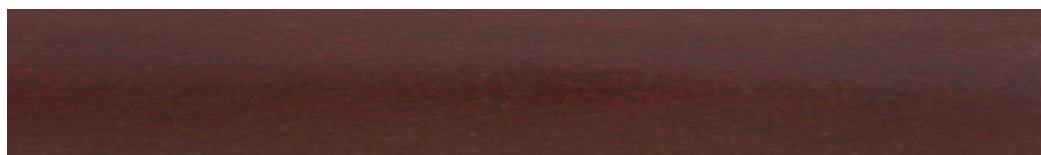

**05.**  
CORINTO



**06.**  
BLANCO



**09.**  
CAOBA



**10.**  
WENGUÉ

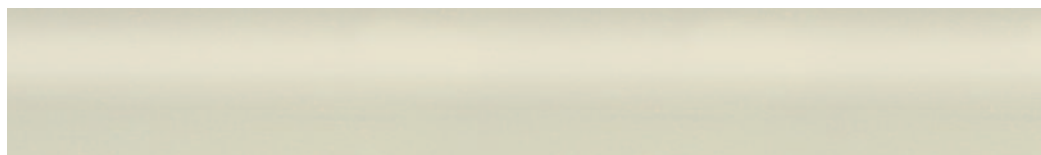

**79.**  
CREMA

**NOTA:** Disponemos de colores patinados bajo pedido, consultar.



## RIEL DE MADERA LACADO: (Con anillas y terminales "Chyc")

BARRA DE MADERA "EXTRA"



REF.	<---->			A	B
0790**4	1,50 m.	x 5		28,41 €/u.	32,65 €/u.
0700**4	1,80 m.	x 5		31,73 €/u.	36,49 €/u.
0701**4	2,10 m.	x 5		34,91 €/u.	40,15 €/u.
0702**4	2,40 m.	x 5		40,55 €/u.	46,60 €/u.
0703**4	2,70 m.	x 5		44,07 €/u.	50,68 €/u.
0704**4	3,00 m.	x 5		46,82 €/u.	53,88 €/u.
0705**4	3,30 m.	x 5		50,16 €/u.	57,70 €/u.
0706**4	3,60 m. (2 barras de 1,80 m.)	x 5		52,91 €/u.	60,86 €/u.

REF.	<---->			A	B
0790**2	1,50 m.	x 6		38,73 €/u.	44,54 €/u.
0700**2	1,80 m.	x 6		43,31 €/u.	49,80 €/u.
0701**2	2,10 m.	x 6		47,50 €/u.	54,63 €/u.
0702**2	2,40 m.	x 6		55,30 €/u.	63,60 €/u.
-	-	-	-	-	-
0455**2	3,00 m. (2 barras de 1,50 m.)	x 6		61,11 €/u.	70,28 €/u.
-	-	-	-	-	-
0706**2	3,60 m. (2 barras de 1,80 m.)	x 6		70,40 €/u.	80,96 €/u.

NOTA: a partir de 2,40 m. inclusive, los rieles llevan 3 soportes.

## RIEL DE MADERA LACADO: (Con anillas y terminales "Lisboa")

BARRA DE MADERA "EXTRA"



REF.	<---->			A
0780**4	1,50 m.	x 5		26,96 €/u.
0781**4	1,80 m.	x 5		29,47 €/u.
0782**4	2,10 m.	x 5		32,56 €/u.
0783**4	2,40 m.	x 5		37,59 €/u.
0750**4	2,70 m.	x 5		40,17 €/u.
0784**4	3,00 m.	x 5		42,96 €/u.
0752**4	3,60 m. (2 barras de 1,80 m.)	x 5		49,20 €/u.

REF.	<---->			A
0780**2	1,50 m.	x 6		38,24 €/u.
0781**2	1,80 m.	x 6		42,11 €/u.
0782**2	2,10 m.	x 6		46,40 €/u.
0783**2	2,40 m.	x 6		51,14 €/u.
-	-	-	-	-
0784**2	3,00 m. (2 barras de 1,50 m.)	x 6		59,83 €/u.
0752**2	3,60 m. (2 barras de 1,80 m.)	x 6		67,87 €/u.

NOTA: a partir de 2,40 m. inclusive, los rieles llevan 3 soportes.

## RIEL DE MADERA LACADO: (Con anillas, soporte techo y terminales "Chyc")

BARRA DE MADERA "EXTRA"



REF.	<---->			A	B
0668**4	1,50 m.	x 5		27,71 €/u.	31,89 €/u.
0669**4	1,80 m.	x 5		30,61 €/u.	35,19 €/u.
0670**4	2,10 m.	x 5		34,19 €/u.	39,30 €/u.
0671**4	2,40 m.	x 5		39,49 €/u.	45,44 €/u.
0672**4	2,70 m.	x 5		43,00 €/u.	49,46 €/u.
0673**4	3,00 m.	x 5		45,79 €/u.	52,68 €/u.
0674**4	3,30 m.	x 5		49,20 €/u.	56,54 €/u.
0675**4	3,60 m. (2 barras de 1,80 m.)	x 5		52,08 €/u.	59,93 €/u.



NOTA: a partir de 2,40 m. inclusive, los rieles llevan 3 soportes.

\*\* Colores A: 01= Nogal. 02= Pino. 03= Teca. 04= Roble. 05= Corinto. 09= Caoba. 10= Wengué.

\*\* Colores B: 06= Blanco. 79= Crema. (sobre pedido)

Código de envasado: 2= Blister. 4= Bolsa de protección.





# BARRA DE MADERA LISA

MADERA "EXTRA"



MADERA "SAMBA"

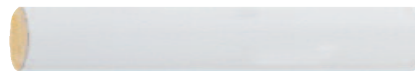

REF.	←-----→			A	B
2929**3	1,50 m.	x 20		10,44 €/u.	12,00 €/u.
2930**3	1,80 m.	x 20		12,48 €/u.	14,35 €/u.
2931**3	2,10 m.	x 20		14,56 €/u.	16,74 €/u.
2932**3	2,40 m.	x 20		16,24 €/u.	18,68 €/u.
2933**3	2,70 m.	x 20		18,90 €/u.	21,74 €/u.
2934**3	3,00 m.	x 20		20,23 €/u.	23,26 €/u.

REF.	←-----→			A	B
1145**3	1,50 m.	x 20		7,56 €/u.	9,07 €/u.
1146**3	1,80 m.	x 20		9,11 €/u.	10,93 €/u.
1147**3	2,10 m.	x 20		10,63 €/u.	12,75 €/u.
1148**3	2,40 m.	x 20		11,76 €/u.	14,11 €/u.
1149**3	2,70 m.	x 20		13,17 €/u.	15,80 €/u.
1150**3	3,00 m.	x 20		14,51 €/u.	17,42 €/u.

## ANILLAS

ANILLA CON HEMBRILLA

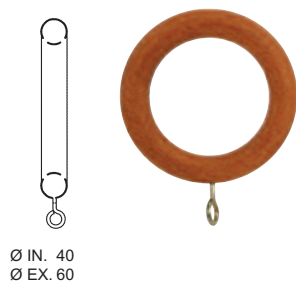

ANILLA CON HEMBRILLA

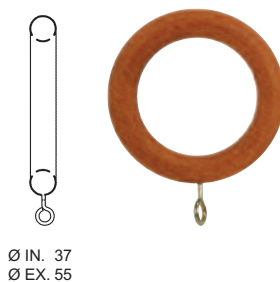

ANILLA SIN HEMBRILLA

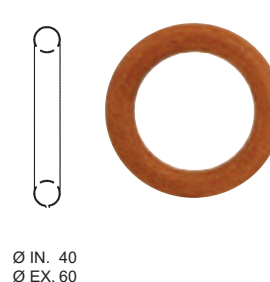

REF.	0305**0	0319**0	0362**2	0345**2	0035**0	
	x 400	x 400		x 10		x 400
	A 0,40 €/u.	-	5,19 €/bl.	-	0,35 €/u.	
	B -	0,58 €/u.	-	7,33 €/bl.	-	

ANILLA "LISBOA"



REF.	1941**0	1941**2	
	x 400		x 10
	A 0,35 €/u.	6,56 €/bl.	
	B 0,39 €/u.	7,21 €/bl.	

\*\* Colores A: 01= Nogal. 02= Pino. 03= Teca. 04= Roble. 05= Corinto. 09= Caoba. 10= Wengué.  
 \*\* Colores B: 06= Blanco. 79= Crema. (sobre pedido)  
 Código de envasado: 0= Granel. 2= Blister. 3= Skin.

MADERA Ø28 mm.



# ACCESORIOS

SOPORTE ABIERTO "C"

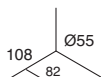

SOPORTE ABIERTO LARGO

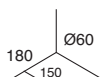

SOPORTE ABIERTO LARGO ESTRIADO

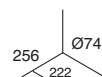

REF.	0376**0	0376**2	0377**0	0377**2	0442**0
	x 50	x 2	x 25	x 1	x 25
A	2,89 €/u.	8,23 €/bl.	4,66 €/u.	7,81 €/bl.	9,03 €/u.
B	3,18 €/u.	9,05 €/bl.	5,12 €/u.	8,60 €/bl.	9,94 €/u.

SOPORTE ABIERTO DOBLE 28-20

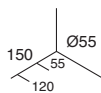

SOPORTE ABIERTO DOBLE 28-20

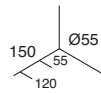

SOPORTE ABIERTO

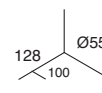

REF.	0086**0	0086**2	0082**0	0082**2	0111**0
	x 25	x 1	x 25	x 1	x 50
A	3,92 €/u.	6,72 €/bl.	3,87 €/u.	6,67 €/bl.	3,19 €/u.
B	4,31 €/u.	7,39 €/bl.	4,26 €/u.	7,34 €/bl.	3,51 €/u.

SOPORTE "LISBOA"

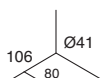

SOPORTE ABIERTO DOBLE 28-28 "LISBOA"

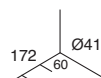

SOPORTE LATERAL "LISBOA"



REF.	1767**0	1767**2	0308**0	0308**2	0310**0	0310**2
	x 50	x 2	x 25	x 1	x 50	x 2
A	2,71 €/u.	6,21 €/bl.	3,07 €/u.	4,62 €/bl.	1,55 €/u.	4,63 €/bl.
B	2,98 €/u.	6,83 €/bl.	3,38 €/u.	5,08 €/bl.	1,70 €/u.	5,09 €/bl.

\*\* Colores A: 01= Nogal. 02= Pino. 03= Teca. 04= Roble. 05= Corinto. 09= Caoba. 10= Wengué.

\*\* Colores B: 06= Blanco. 79= Crema. (sobre pedido)

Código de envasado: 0= Granel. 2= Blister.



# ACCESORIOS

SOPORTE LATERAL



SOPORTE LATERAL ESPECIAL



SOPORTE TECHO



REF.	1493**0	1493**2	1067**0	0565**0	0565**2
	x 50	x 2	x 50	x 50	x 2
A	1,95 €/u.	6,39 €/bl.	1,95 €/u.	2,58 €/u.	7,71 €/bl.
B	2,14 €/u.	7,04 €/bl.	2,14 €/u.	2,84 €/u.	8,47 €/bl.

SOPORTE TECHO ESQUINA



SOPORTE TECHO "LISBOA"



SOPORTE PARED ESQUINA  
(solo para ref. 0376\*\*0/0376\*\*2)

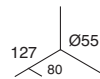

REF.	0292**0	0292**2	1343**0	1343**2	0240**0	0240**2
	x 50	x 1	x 50	x 2	x 25	x 1
A	2,67 €/u.	5,25 €/bl.	2,49 €/u.	6,22 €/bl.	3,80 €/u.	6,56 €/bl.
B	2,94 €/u.	5,78 €/bl.	2,74 €/u.	6,84 €/bl.	4,18 €/u.	7,21 €/bl.

SOPORTE PARED ESQUINA  
(solo para ref. 0111\*\*0)



SOPORTE EXTENSIBLE

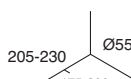

REF. 1474+1475



ACCESORIO SOPORTE EXTENSIBLE 28-20  
(para utilizar con soporte 1474\*\*0/1474\*\*2)



REF.	1465**0	1474**0	1474**2	1475**0
	x 25	x 25	x 1	x 25
A	3,80 €/u.	3,97 €/u.	6,71 €/bl.	2,04 €/u.
B	4,18 €/u.	4,36 €/u.	7,38 €/bl.	2,25 €/u.

\*\* Colores A: 01= Nogal. 02= Pino. 03= Teca. 04= Roble. 05= Corinto. 09= Caoba. 10= Wengué.  
 \*\* Colores B: 06= Blanco. 79= Crema. (sobre pedido)  
 Código de envasado: 0= Granel. 2= Blister.

# TERMINALES

SOPORTE "MARBELLA"

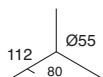

SOPORTE TECHO "MARBELLA"



TERMINAL "ALMERÍA"



REF.	0567**0	0568**0	1777**0
	x 50	x 50	x 50
**	3,04 €/u.	2,60 €/u.	0,80 €/u.

TERMINAL "CHYC"

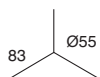

TERMINAL "MOTRIL"



TERMINAL "NERJA"



REF.	0033**0	0033**2	0309**0	0309**2	1332**0	1332**2
	x 50	x 2	x 50	x 1	x 50	x 1
A	2,01 €/u.	6,63 €/bl.	2,05 €/u.	3,70 €/bl.	1,73 €/u.	4,21 €/bl.
B	2,21 €/u.	7,29 €/bl.	2,25 €/u.	4,07 €/bl.	1,90 €/u.	4,63 €/bl.

TERMINAL "LISBOA"



TERMINAL "ESFERA"



TERMINAL "ESFERA" CON BOTÓN



TERMINAL "ESPECIAL"



REF.	1614**0	1614**2	1479**0	1479**2	1466**0	1466**2	1469**0	1469**2
	x 50	x 2	x 50	x 2	x 50	x 2	x 50	x 2
A	1,67 €/u.	4,97 €/bl.	1,32 €/u.	5,27 €/bl.	1,50 €/u.	5,47 €/bl.	1,29 €/u.	5,12 €/bl.
B	1,84 €/u.	5,47 €/bl.	1,46 €/u.	5,80 €/bl.	1,65 €/u.	6,02 €/bl.	1,42 €/u.	5,64 €/bl.

\*\* Colores A: 01= Nogal. 02= Pino. 03= Teca. 04= Roble. 05= Corinto. 09= Caoba. 10= Wengué.

\*\* Colores B: 06= Blanco. 79= Crema. (sobre pedido)

Código de envasado: 0= Granel. 2= Blister.

## SUGERENCIAS DE MONTAJE: Riel doble de Ø28-28

(Con soporte doble 0082\*\*0 y terminal posterior especial 1469\*\*0)



COMPONENTES (CON SOPORTE DOBLE 28-28)					
Referencia barra extra Ø28+Ø28 (Skin)	<---->	Anillas 0305**0	Soportes 0082**0	Terminales 0033**0 + 1469**0	€/ CONJUNTO
2929**3 + 2929**3	1,50 m.	16 + 16	2	2 + 2	48,02 €/u.
2930**3 + 2930**3	1,80 m.	18 + 18	2	2 + 2	53,70 €/u.
2931**3 + 2931**3	2,10 m.	22 + 22	2	2 + 2	61,06 €/u.
2932**3 + 2932**3	2,40 m.	24 + 24	3	2 + 2	69,89 €/u.
2933**3 + 2933**3	2,70 m.	28 + 28	3	2 + 2	78,41 €/u.
2934**3 + 2934**3	3,00 m.	30 + 30	3	2 + 2	82,67 €/u.

## SUGERENCIAS DE MONTAJE: Riel doble de Ø28-20

(Con soporte doble 0086\*\*0 y terminal posterior especial 1484\*\*0)



COMPONENTES (CON SOPORTE DOBLE 28-20)					
Referencia barra extra Ø28+Ø20 (Skin)	<---->	Anillas 0305**0+0290**0	Soportes 0086**0	Terminales 0033**0 + 1484**0	€/ CONJUNTO
2929**3 + 2936**3	1,50 m.	16 + 16	2	2 + 2	41,39 €/u.
2930**3 + 2937**3	1,80 m.	18 + 18	3	2 + 2	49,87 €/u.
2931**3 + 2938**3	2,10 m.	22 + 22	3	2 + 2	55,77 €/u.
2932**3 + 2939**3	2,40 m.	24 + 24	3	2 + 2	59,99 €/u.
2933**3 + 2962**3	2,70 m.	28 + 28	3	2 + 2	66,46 €/u.
2934**3 + 2987**3	3,00 m.	30 + 30	3	2 + 2	70,30 €/u.

## SUGERENCIAS DE MONTAJE: Riel doble de Ø20-20

(Con soporte doble 0076\*\*0 y terminal posterior especial 1484\*\*0)



COMPONENTES (CON SOPORTE DOBLE 20-20)					
Referencia barra extra Ø20+Ø20 (Skin)	<---->	Anillas 0290**0	Soportes 0076**0	Terminales 0570**0 + 1484**0	€/ CONJUNTO
2936**3 + 2936**3	1,50 m.	16 + 16	2	2 + 2	31,02 €/u.
2937**3 + 2937**3	1,80 m.	18 + 18	3	2 + 2	37,22 €/u.
2938**3 + 2938**3	2,10 m.	22 + 22	3	2 + 2	41,66 €/u.
2939**3 + 2939**3	2,40 m.	24 + 24	3	2 + 2	45,14 €/u.
2962**3 + 2962**3	2,70 m.	28 + 28	3	2 + 2	49,56 €/u.
2987**3 + 2987**3	3,00 m.	30 + 30	3	2 + 2	52,98 €/u.

\*\* Colores pulimentados: 01= Nogal. 02= Pino. 03= Teca. 04= Roble. 05= Corinto. 09= Caoba. 10= Wengué.



# COLORES

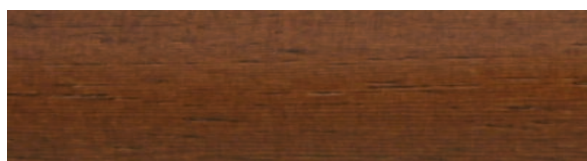

01. NOGAL



06. BLANCO



02. PINO

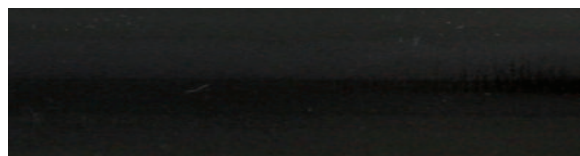

07. NEGRO



03. TECA

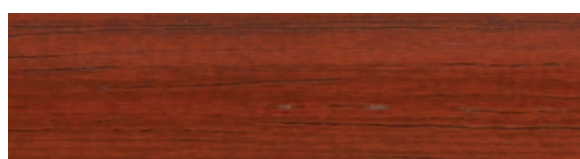

09. CAOBA

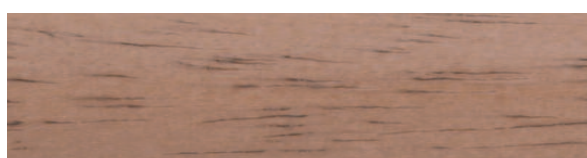

04. ROBLE



10. WENGUÉ

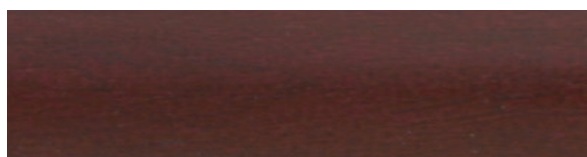

05. CORINTO

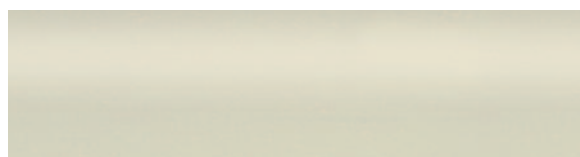

79. CREMA

## RIEL DE MADERA LACADO: (Con anillas y terminales "Chyc")

BARRA DE MADERA "EXTRA"



REF.	<---->			A	B
0772**4	1,20 m.	x 10		16,39 €/u.	18,85 €/u.
0773**4	1,50 m.	x 10		18,42 €/u.	21,20 €/u.
0774**4	1,80 m.	x 10		22,24 €/u.	25,58 €/u.
0775**4	2,10 m.	x 10		24,28 €/u.	27,91 €/u.
0776**4	2,40 m.	x 10		26,22 €/u.	30,15 €/u.
0777**4	2,70 m.	x 10		30,23 €/u.	34,74 €/u.
0778**4	3,00 m.	x 10		32,44 €/u.	37,31 €/u.

REF.	<---->			A	B
0772**2	1,20 m.	x 6		23,84 €/u.	27,38 €/u.
0773**2	1,50 m.	x 6		26,67 €/u.	30,67 €/u.
0774**2	1,80 m.	x 6		31,96 €/u.	36,78 €/u.
0775**2	2,10 m.	x 6		35,24 €/u.	40,52 €/u.
0776**2	2,40 m.	x 6		38,39 €/u.	44,13 €/u.
-	-	-		-	-
-	-	-		-	-

NOTA: a partir de 1,80 m. inclusive, los rieles llevan 3 soportes.

\*\* Colores A: 01= Nogal. 02= Pino. 03= Teca. 04= Roble. 05= Corinto. 09= Caoba. 10= Wengué.  
 \*\* Colores B: 06= Blanco. 07= Negro. 79= Crema. (sobre pedido)  
 Código de envasado: 2= Blister. 4= Bolsa de protección.



# BARRA DE MADERA LISA

MADERA "EXTRA"

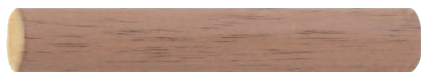

REF.	←-----→			A	B
2935**3	1,20 m.	x 36		4,84 €/u.	5,57 €/u.
2936**3	1,50 m.	x 36		6,01 €/u.	6,91 €/u.
2937**3	1,80 m.	x 36		7,21 €/u.	8,29 €/u.
2938**3	2,10 m.	x 36		8,39 €/u.	9,65 €/u.
2939**3	2,40 m.	x 36		9,61 €/u.	11,05 €/u.
2962**3	2,70 m.	x 36		10,78 €/u.	12,40 €/u.
2987**3	3,00 m.	x 36		11,97 €/u.	13,76 €/u.

# ANILLAS Y ACCESORIOS LACADOS

ANILLA CON <sup>(1)</sup> Y SIN <sup>(2)</sup> HEMBRILLA

ANILLA CON HEMBRILLA

ANILLA PLÁSTICO BRILLO CON HEMBRILLA

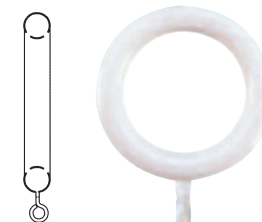
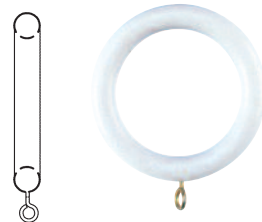
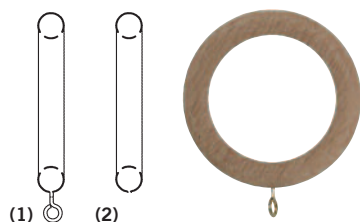

REF.	0290**0	0290**2	0115**0	0210**0	0210**2	1451060	1451062
	x 700	x 10	x 700	x 700	x 10	x 50	x 10
A	0,26 €/u.	4,86 €/bl.	0,19 €/u.	-	-	-	-
B	-	-	-	0,41 €/u.	5,86 €/bl.	0,20 €/u.	2,70 €/bl.

TERMINAL "CHYC"

TERMINAL "ESFERA"

TERMINAL "ESPECIAL"

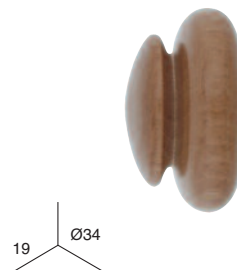
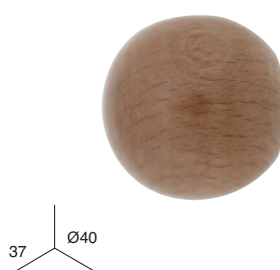
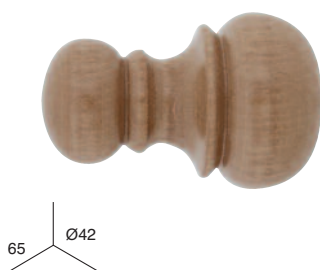

REF.	0570**0	0570**2	1478**0	1478**2	1484**0	1484**2
	x 50	x 2	x 50	x 2	x 50	x 2
A	1,32 €/u.	5,34 €/bl.	1,06 €/u.	4,77 €/bl.	1,26 €/u.	4,96 €/bl.
B	1,45 €/u.	5,88 €/bl.	1,17 €/u.	5,24 €/bl.	1,38 €/u.	5,45 €/bl.

\*\* Colores A: 01= Nogal. 02= Pino. 03= Teca. 04= Roble. 05= Corinto. 09= Caoba. 10= Wengué.  
 \*\* Colores B: 06= Blanco. 07= Negro. 79= Crema. (sobre pedido)  
 Código de envasado: 0= Granel. 2= Blister.

MADERA Ø20 mm.

# ACCESORIOS LACADOS

RECOGE CORTINAS



SOPORTE ABIERTO

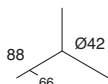

SOPORTE ABIERTO DOBLE 20-20

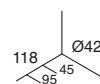

REF. 1457\*\*0

1457\*\*2

0074\*\*0

0074\*\*2

0076\*\*0

0076\*\*2

x 50

x 1

x 50

x 2

x 25

x 1



A 1,92 €/u.

4,54 €/bl.

2,28 €/u.

7,11 €/bl.

2,76 €/u.

5,57 €/bl.

B 2,11 €/u.

4,99 €/bl.

2,51 €/u.

7,81 €/bl.

3,03 €/u.

6,12 €/bl.

SOPORTE EXTENSIBLE

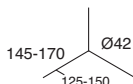

SOPORTE LATERAL

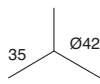

SOPORTE PARED ESQUINA

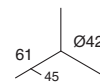

REF. 1461\*\*0

1461\*\*2

1701\*\*0

1701\*\*2

1454\*\*0

1454\*\*2

x 25

x 1

x 50

x 2

x 50

x 1



A 3,11 €/u.

5,89 €/bl.

1,47 €/u.

5,42 €/bl.

1,97 €/u.

4,65 €/bl.

B 3,42 €/u.

6,48 €/bl.

1,62 €/u.

5,96 €/bl.

2,17 €/u.

5,12 €/bl.

SOPORTE TECHO



SOPORTE TECHO ESQUINA



SOPORTE TERMINAL

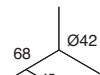

REF. 0664\*\*0

0664\*\*2

1455\*\*0

1455\*\*2

1456\*\*0

1456\*\*2

x 50

x 2

x 50

x 1

x 50

x 2



A 1,88 €/u.

6,39 €/bl.

2,12 €/u.

4,79 €/bl.

1,85 €/u.

6,38 €/bl.

B 2,07 €/u.

7,04 €/bl.

2,34 €/u.

5,27 €/bl.

2,04 €/u.

7,02 €/bl.

\*\* Colores A: 01= Nogal. 02= Pino. 03= Teca. 04= Roble. 05= Corinto. 09= Caoba. 10= Wengué.

\*\* Colores B: 06= Blanco. 07= Negro. 79= Crema. (sobre pedido)

Código de envasado: 0= Granel. 2= Blister.





# COLORES

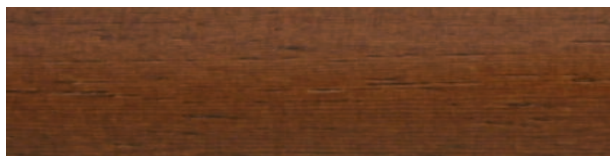

01. NOGAL

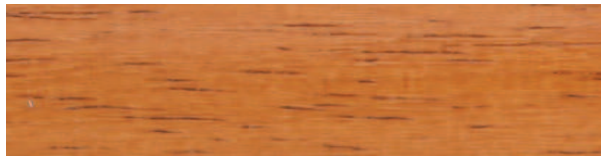

03. TECA



02. PINO



06. BLANCO

## RIEL DE MADERA LACADO

(Con anillas y terminales "Chyc")

BARRA DE MADERA "EXTRA"

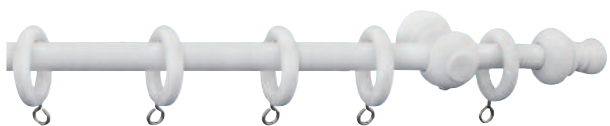

REF.	←----			A	B
-	-	-	-	-	-
1318**4	0,90 m.	x 20		9,63 €/u.	11,09 €/u.
1319**4	1,20 m.	x 20		10,53 €/u.	12,10 €/u.
1320**4	1,50 m.	x 20		13,31 €/u.	15,30 €/u.
1321**4	1,80 m.	x 20		13,99 €/u.	16,08 €/u.

NOTA: a partir de 1,50 m. inclusive, los rieles llevan 3 soportes.

## BARRA DE MADERA LISA

MADERA "EXTRA"



REF.	←----			A	B
1914**3	0,90 m.	x 100		2,01 €/u.	2,42 €/u.
1915**3	1,20 m.	x 100		2,60 €/u.	3,12 €/u.
1916**3	1,50 m.	x 100		3,61 €/u.	4,34 €/u.
1917**3	1,80 m.	x 100		3,89 €/u.	4,67 €/u.
1976**3	2,10 m.	x 100		4,47 €/u.	5,37 €/u.
1977**3	2,40 m.	x 100		5,06 €/u.	6,07 €/u.

## ACCESORIOS

ANILLA CON HEMBRILLA



Ø IN. 21  
Ø EX. 35



ANILLA SIN HEMBRILLA

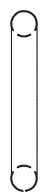

Ø IN. 21  
Ø EX. 35



ANILLA CON HEMBRILLA

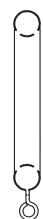

Ø IN. 21  
Ø EX. 35



REF.	0209**0	0209**2	0116**0	0561060	0561062
	x 1400	x 10	x 1400	x 1400	x 10
	A	A	A	-	-
	0,16 €/u.	4,29 €/bl.	0,13 €/u.	-	-
	B	-	-	0,25 €/u.	5,08 €/bl.

\*\* Colores A: 01= Nogal. 02= Pino. 03= Teca.

\*\* Colores B: 06= Blanco.

Código de envasado: 0= Granel. 3= Skin. 4= Bolsa de protección.

MADERA Ø12 mm.

# ACCESORIOS

ANILLA PLÁSTICO BRILLO



Ø IN. 19  
Ø EX. 31

TERMINAL "CHYC"

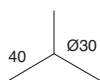

REF.	0361060	0072**0	0072**2
	x 100	x 50	x 2
A	-	0,77 €/u.	4,07 €/bl.
B	0,11 €/u.	0,85 €/u.	4,48 €/bl.

SOPORTE ABIERTO



SOPORTE ABIERTO DOBLE 12-12

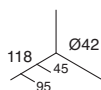

SOPORTE LATERAL



REF.	0070**0	0070**2	1471**0	1471**2	1463**0	1463**2
	x 50	x 2	x 25	x 1	x 50	x 2
A	1,37 €/u.	5,26 €/bl.	3,74 €/u.	6,35 €/bl.	1,20 €/u.	4,98 €/bl.
B	1,51 €/u.	5,79 €/bl.	4,11 €/u.	6,98 €/bl.	1,31 €/u.	5,47 €/bl.

SOPORTE EXTENSIBLE

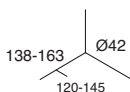

SOPORTE CERRADO

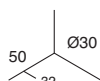

SOPORTE TERMINAL



REF.	1494**0	1494**2	1460**0	1460**2	1458**0	1458**2
	x 25	x 1	x 50	x 2	x 50	x 2
A	3,09 €/u.	5,80 €/bl.	1,02 €/u.	4,62 €/bl.	1,00 €/u.	4,58 €/bl.
B	3,40 €/u.	6,38 €/bl.	1,13 €/u.	5,08 €/bl.	1,10 €/u.	5,03 €/bl.

\*\* Colores A: 01= Nogal. 02= Pino. 03= Teca.  
\*\* Colores B: 06= Blanco.  
Código de envasado: 0= Granel. 2= Blister.



# ACCESORIOS COMUNES

TIRADOR MOSQUETÓN



TIRADOR CON GANCHO



	0,75 m.	1,00 m.		0,75 m.	1,00 m.
REF.	0198**0	0698**0	0698**2	0543**0	0284**0
	x 35	x 35	x 1	x 35	x 35
A	4,37 €/u.	4,80 €/u.	6,66 €/bl.	4,41 €/u.	4,94 €/u.
B	4,80 €/u.	5,28 €/u.	7,32 €/bl.	4,85 €/u.	5,43 €/u.

RECOGE CORTINAS



RECOGE CORTINAS



PINZAS PARA ANILLAS



	REF. 1457**0	1457**2	0056**0	0056**2	0352440	0352442 (1)
	x 50	x 1	x 50	x 1	x 100	x 6
A	1,92 €/u.	4,54 €/bl.	4,73 €/u.	7,94 €/bl.	COLOR DORADO	0,36 €/u.
B	2,11 €/u.	4,99 €/bl.	5,20 €/u.	8,74 €/bl.		3,24 €/bl.

(1): Servible en skin hasta fin de existencias

PATÍN DESLIZANTE PARA BARRA Ø35

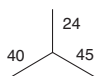

PATÍN DESLIZANTE PARA BARRA Ø28

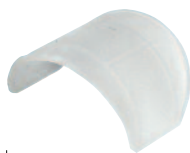

PATÍN DESLIZANTE PARA BARRA Ø20



PATÍN DESLIZANTE PARA BARRA Ø12

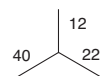

	REF. 2550200	2550202	2549200	2549202	2927200	2927202	2928200	2928202
	x 50	x 10	x 50	x 10	x 50	x 10	x 50	x 10
20	0,64 €/u.	9,85 €/bl.	0,62 €/u.	9,68 €/bl.	0,56 €/u.	8,08 €/bl.	0,48 €/u.	6,73 €/bl.

\*\* Colores A: 01= Nogal. 02= Pino. 03= Teca. 04= Roble. 05= Corinto. 09= Caoba. 10= Wengué. / 20= Transparente.  
 \*\* Colores B: 06= Blanco. 07= Negro. 79= Crema. (sobre pedido)  
 Código de envasado: 0= Granel. 2= Blister



# ACCESORIOS COMUNES

BOLSA DE 25 ESPÁRRAGOS PARA SOPORTE DE Ø35-28 + 25 TORNILLOS DE FIJACIÓN Y TACOS



REF. 0049440

x 25



44

5,08 €/bolsa

BOLSA DE 25 ESPÁRRAGOS PARA SOPORTE DE Ø20 + 25 TORNILLOS DE FIJACIÓN Y TACOS



REF. 0073440

x 25

3,20 €/bolsa

ESPÁRRAGO SIN PUNTA PARA TERMINALES DE Ø50

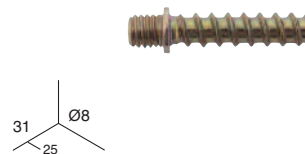

REF. 1470440

x 25

3,67 €/Caja

BOLSA DE 25 ESPÁRRAGOS PARA SOPORTE DE Ø12 + 25 TORNILLOS DE FIJACIÓN Y TACOS



REF. 1486440

x 25



44

3,56 €/Caja

ESPÁRRAGO SOPORTE MINI

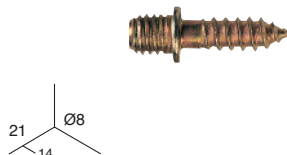

REF. 1459440

x 25

2,39 €/Caja

UNIÓN BARRA MADERA

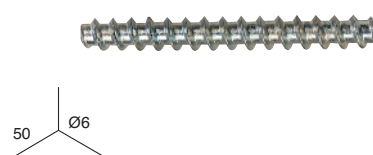

REF. 1450440

x 25

3,95 €/Caja

REF. 1450442

x 2

1,12 €/bl.

PATA CIERRE (IZQUIERDA/DERECHA)

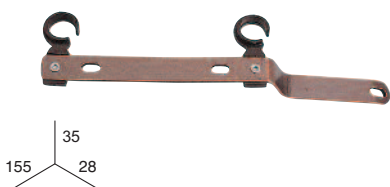

REF. 0439\*\*0

x 25



01

20,52 €/Caja

02

20,52 €/Caja

03

20,52 €/Caja

GANCHO ANILLA MADERA Ø35-28

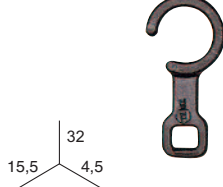

REF. 0173\*\*0

x 100

3,19 €/Caja

3,19 €/Caja

3,19 €/Caja

GANCHO ANILLA MADERA Ø20-12

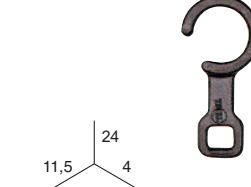

REF. 0566\*\*0

x 100

2,49 €/Caja

2,49 €/Caja

2,49 €/Caja

GANCHO CINTA ANILLA Ø35-28

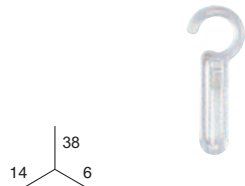

REF. 1464\*\*0

x 100



01

8,65 €/Caja

20

12,30 €/Caja

REF. 1464\*\*2

x 10

1,93 €/bl.

2,33 €/bl.

PLETINA ACCESORIO Ø50 Y Ø35

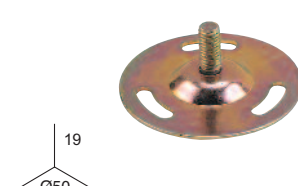

REF. 0170440

x 25

14,73 €/Caja



44

REF. 0170442

x 2

3,10 €/bl.

PLETINA ACCESORIO Ø28

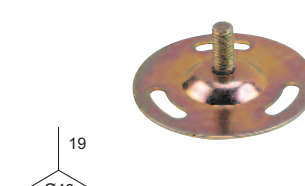

REF. 0150440

x 25

14,32 €/Caja

REF. 0150442

x 2

2,82 €/bl.

\*\* Colores: 01= Nogal. 02= Pino. 03= Teca. 20= Transparente. 44= Dorado.  
Código de envasado: 0= Granel. 2= Blister..



CNYC



# Gama Infantil



## COLORES GAMA INFANTIL



**06.**  
BLANCO



**22.**  
AZUL CLARO



**23.**  
PISTACHO



**83.**  
FUCSIA

## BARRA DE MADERA LISA Y ANILLA

MADERA "SAMBA"



ANILLA CON HEMBRILLA

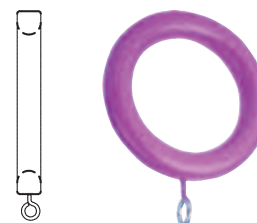

Ø IN. 37  
Ø EX. 55

REF.	←---→			COLORES
1145**3	1,50 m.	x 20		9,07 €/u.
1146**3	1,80 m.	x 20		10,93 €/u.
1147**3	2,10 m.	x 20		12,75 €/u.
1148**3	2,40 m.	x 20		14,11 €/u.
1150**3	3,00 m.	x 20		17,42 €/u.

<b>0345**2</b>
x 10
7,33 €/bl.

\*\* Colores: 06= Blanco. 22= Azul claro. 23= Pistacho. 83= Fucsia.  
Código de envasado: 2= Blister. 3= Skin.





# ACCESORIOS GAMA INFANTIL

TERMINAL "ESFERA"



TERMINAL "LISBOA"



TERMINAL "ALMERÍA"



REF.	<b>2617**2</b>	<b>2618**2</b>	<b>1704**2</b>
	x 1	x 1	x 2
**	<b>3,50 €/bl.</b>	<b>3,50 €/bl.</b>	<b>6,18 €/bl.</b>

TERMINAL "LUNA"



TERMINAL "LUNA" SERIGRAFIADO



TERMINAL "ESTRELLA"



REF.	<b>2624**2</b>	<b>2625222</b>	<b>2626062</b>	<b>2626222</b>
	x 1	x 1	x 1	x 1
**	<b>8,38 €/bl.</b>	<b>9,54 €/bl.</b>	<b>8,38 €/bl.</b>	<b>8,38 €/bl.</b>

TERMINAL "ESTRELLA" SERIGRAFIADO



TERMINAL "TULIPÁN"



TERMINAL "TULIPÁN" SERIGRAFIADO



REF.	<b>2627232</b>	<b>2627832</b>	<b>2628062</b>	<b>2628222</b>	<b>2629232</b>	<b>2629832</b>
	x 1	x 1	x 1	x 1	x 1	x 1
**	<b>9,54 €/bl.</b>	<b>9,54 €/bl.</b>	<b>8,38 €/bl.</b>	<b>8,38 €/bl.</b>	<b>9,54 €/bl.</b>	<b>9,54 €/bl.</b>

\*\* Colores: 06= Blanco. 22= Azul claro. 23= Pistacho. 83= Fucsia.

\*\* Colores para terminal Luna serigrafiado: 22= Azul claro/Blanco

\*\* Colores para terminales Tulipán y Estrella serigrafiados: 23= Pistacho/Verde 83=. Fucsia/Rosa

Código de envasado: 2= Blister.

# ACCESORIOS GAMA INFANTIL

SOPORTE EXTENSIBLE

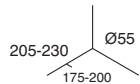

REF. 1474\*\*2



\*\* 7,38 €/bl.

SOPORTE ABIERTO

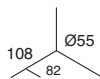

REF. 2619\*\*2



5,28 €/bl.

SOPORTE LATERAL



REF. 2621\*\*2



4,10 €/bl.

SOPORTE TECHO



REF. 2630\*\*2



\*\* 5,12 €/bl.

SOPORTE "ESTORIL"

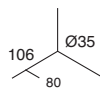

REF. 2622\*\*2



3,86 €/bl.

SOPORTE DOBLE "ESTORIL"

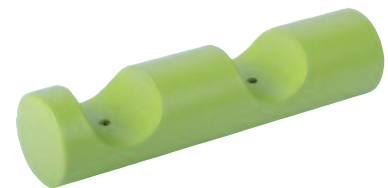

REF. 2631\*\*2



4,41 €/bl.

TIRADOR DE 1,00 m.



REF. 0698\*\*2



\*\* 7,32 €/bl.

\*\* Colores: 06= Blanco. 22= Azul claro. 23= Pistacho. 83= Fucsia.  
Código de envasado: 2= Blister.

## SUGERENCIAS DE MONTAJE:

Riel simple de Ø28 mm.

(Con soporte Estoril 2622\*\*2 y anillas)

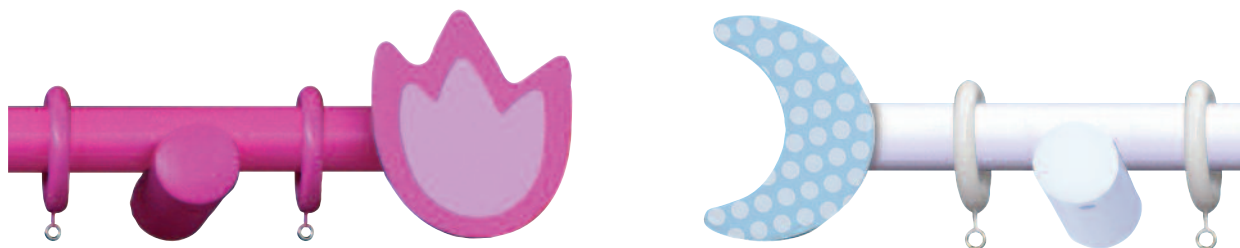

COMPONENTES							
Barra Ø28 mm.	<---->	Anillas	Soporte Estoril	Terminales Esfera ó Lisboa	Terminal Almería	Terminales lisos (Luna/Estrella/Tulipán)	Term. Serigrafiados (Luna/Estrella/Tulipán)
1145**3	1,50 m.	16	2 bl.	35,52 €/u.	34,70 €/u.	45,28 €/u.	47,60 €/u.
1146**3	1,80 m.	18	3 bl.	42,70 €/u.	41,88 €/u.	52,46 €/u.	54,78 €/u.
1147**3	2,10 m.	22	3 bl.	47,46 €/u.	46,64 €/u.	57,22 €/u.	59,54 €/u.
1148**3	2,40 m.	24	3 bl.	50,28 €/u.	49,46 €/u.	60,04 €/u.	62,36 €/u.
1150**3	3,00 m.	30	3 bl.	57,99 €/u.	57,17 €/u.	67,75 €/u.	70,07 €/u.

## SUGERENCIAS DE MONTAJE:

Riel doble de Ø28-Ø28 mm.

(Con soporte Estoril doble 2631\*\*2, anillas y terminal posterior Almería 1704\*\*2)



COMPONENTES							
Barra Ø28 mm.	<---->	Anillas	Soporte doble Estoril	Terminales Esfera ó Lisboa	Terminal Almería	Terminales lisos (Luna/Estrella/Tulipán)	Term. Serigrafiados (Luna/Estrella/Tulipán)
1145**3 x 2	1,50 m.	16 + 16	2 bl.	63,60 €/u.	62,78 €/u.	73,36 €/u.	75,68 €/u.
1146**3 x 2	1,80 m.	18 + 18	3 bl.	74,66 €/u.	73,84 €/u.	84,42 €/u.	86,74 €/u.
1147**3 x 2	2,10 m.	22 + 22	3 bl.	82,70 €/u.	81,88 €/u.	92,46 €/u.	94,78 €/u.
1148**3 x 2	2,40 m.	24 + 24	3 bl.	89,81 €/u.	88,99 €/u.	99,57 €/u.	101,89 €/u.
1150**3 x 2	3,00 m.	30 + 30	3 bl.	105,23 €/u.	104,41 €/u.	114,99 €/u.	117,31 €/u.

**NOTA:** Los accesorios de la gama infantil solo están disponibles en BLISTER.

\*\* Colores: 06= Blanco. 22= Azul claro. 23= Pistacho. 83= Fucsia.

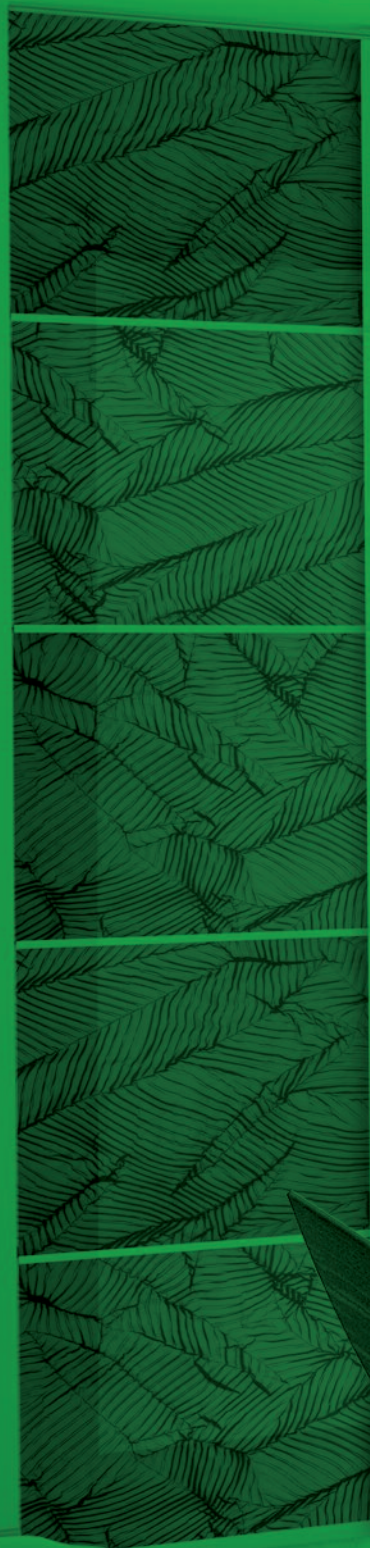

# Panel Japonés

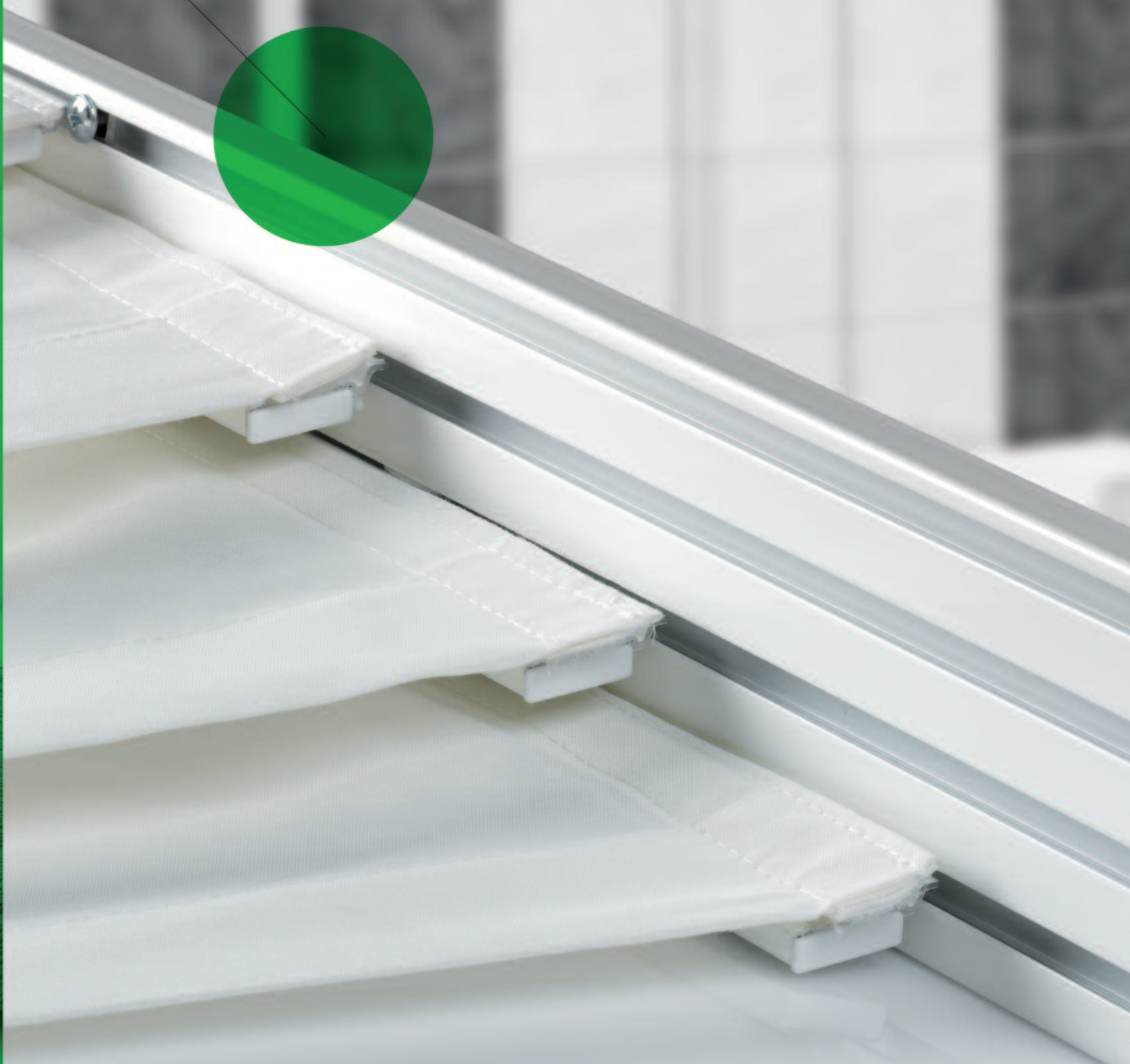

# PANEL JAPONÉS a medida

con cordón/ sin cordón/ portatelas múltiple (soporte a techo)



## NOTA:

1. Para referencias y precios: cuando se pidan medidas intermedias a las estándar se le aplicará la referencia y precio de la inmediata superior.
2. El accionamiento a doble mando se incrementará en un 10%.
3. Para formular los pedidos de rieles a medida utilizar la "HOJA DE PEDIDO-PANEL JAPONÉS" (AL FINAL DE LA TARIFA/ CATÁLOGO)



## PERFIL 2 VÍAS

<---->		Referencia con cordón	Referencia sin cordón	Referencia múltiple 	06	40
1,50 m.	x 1	7014060	7038060	7062060	56,19 €/u.	-
2,00 m.	x 1	7015060	7039060	7063060	64,86 €/u.	-
2,50 m.	x 1	7016060	7040060	7064060	81,15 €/u.	-
3,00 m.	x 1	7017060	7041060	7065060	93,93 €/u.	-
3,50 m.	x 1	7018060	7042060	7066060	113,55 €/u.	-
4,00 m.	x 1	7019060	7043060	7067060	120,67 €/u.	-

### COMPONENTES

**PERFIL 2 VÍAS:** Terminal 2 vías (1 juego), perfil portatela (x m.), correderas (2 x portatela), tope enlace "L" (1 u.), Tope enlace "T" (1 u.), soporte techo corto (1 cada 60-70 cm.), patín (1 u.), tope portatela fijo (1 u.), cinta felpa "L" (x m.), pletina contrapeso 40x3 (x m.), tapones pletina contrapeso (x m.), contrapeso 70 grs. (1u.).



## PERFIL 3 VÍAS

<---->		Referencia con cordón	Referencia sin cordón	Referencia múltiple 	06	40
1,50 m.	x 1	7020**0	7044**0	7068**0	65,52 €/u.	68,82 €/u.
2,00 m.	x 1	7021**0	7045**0	7069**0	79,17 €/u.	83,11 €/u.
2,50 m.	x 1	7022**0	7046**0	7070**0	89,82 €/u.	94,29 €/u.
3,00 m.	x 1	7023**0	7047**0	7071**0	103,44 €/u.	108,56 €/u.
3,50 m.	x 1	7024**0	7048**0	7072**0	126,22 €/u.	132,46 €/u.
4,00 m.	x 1	7025**0	7049**0	7073**0	133,88 €/u.	140,48 €/u.

### COMPONENTES

**PERFIL 3 VÍAS:** Terminal 3 vías (1 juego), perfil portatela (x m.), correderas (2 x portatela), tope enlace "L" (2 u.), tope enlace "T" (2 u.), soporte techo corto (1 cada 60-70 cm.), patín (1 u.), tope portatela fijo (1 u.), cinta felpa "L" (x m.), pletina contrapeso 40x3 (x m.), tapones pletina contrapeso (x m.), contrapeso 70 grs. (1 u.).



## PERFIL 4 VÍAS

<---->		Referencia con cordón	Referencia sin cordón	Referencia múltiple 	06	40
1,50 m.	x 1	7026**0	7050**0	7074**0	75,84 €/u.	79,62 €/u.
2,00 m.	x 1	7027**0	7051**0	7075**0	91,90 €/u.	96,47 €/u.
2,50 m.	x 1	7028**0	7052**0	7076**0	107,21 €/u.	112,59 €/u.
3,00 m.	x 1	7029**0	7053**0	7077**0	119,22 €/u.	125,23 €/u.
3,50 m.	x 1	7030**0	7054**0	7078**0	143,22 €/u.	150,36 €/u.
4,00 m.	x 1	7031**0	7055**0	7079**0	152,83 €/u.	160,50 €/u.
4,50 m.	x 1	7094**0	7102**0	7086**0	168,67 €/u.	177,06 €/u.
5,00 m.	x 1	7095**0	7103**0	7087**0	184,33 €/u.	193,59 €/u.
5,50 m.	x 1	7096**0	7104**0	7088**0	203,49 €/u.	213,65 €/u.
6,00 m.	x 1	7097**0	7105**0	7089**0	216,09 €/u.	226,83 €/u.

### COMPONENTES

**PERFIL 4 VÍAS:** Terminal 4 vías (1 juego), perfil portatela (x m.), correderas (2 x portatela), tope enlace "L" (3 u.), tope enlace "T" (3 u.), soporte techo largo (1 cada 60-70 cm.), patín (1 u.), tope portatela fijo (1 u.), cinta felpa "L" (x m.), pletina contrapeso 40x3 (x m.), tapones pletina contrapeso (x m.), contrapeso 70 grs. (1 u.).

## PERFIL 5 VÍAS

<---->		Referencia con cordón	Referencia sin cordón	Referencia múltiple 	06	40
1,50 m.	x 1	7032**0	7056**0	7080**0	82,14 €/u.	86,28 €/u.
2,00 m.	x 1	7033**0	7057**0	7081**0	98,55 €/u.	103,44 €/u.
2,50 m.	x 1	7034**0	7058**0	7082**0	113,63 €/u.	119,28 €/u.
3,00 m.	x 1	7035**0	7059**0	7083**0	130,53 €/u.	136,94 €/u.
3,50 m.	x 1	7036**0	7060**0	7084**0	158,50 €/u.	166,33 €/u.
4,00 m.	x 1	7037**0	7061**0	7085**0	166,36 €/u.	174,64 €/u.
4,50 m.	x 1	7098**0	7106**0	7090**0	186,35 €/u.	195,60 €/u.
5,00 m.	x 1	7099**0	7107**0	7091**0	203,51 €/u.	213,69 €/u.
5,50 m.	x 1	7100**0	7108**0	7092**0	219,82 €/u.	230,80 €/u.
6,00 m.	x 1	7101**0	7109**0	7093**0	238,01 €/u.	249,82 €/u.

### COMPONENTES

**PERFIL 5 VÍAS:** Terminal 5 vías (1 juego), perfil portatela (x m.), correderas (2 x portatela), tope enlace "L" (4 u.), tope enlace "T" (4 u.), soporte techo largo (1 cada 60-70 cm.), patín (1 u.), tope portatela fijo (1 u.), cinta felpa "L" (x m.), pletina contrapeso 40x3 (x m.), tapones pletina contrapeso (x m.), contrapeso 70 grs. (1 u.).

\*\* Colores: 06= Blanco. 40= Plata.  
Código de envasado: 0= Granel.



# PANEL JAPONÉS EN BLISTER

3 VÍAS/ 1,70 m.

4 VÍAS/ 2,25 m.

5 VÍAS/ 2,80 m.

REF.	7136062	7137062	7138062
	x 2	x 2	x 2
06	92,23 €/bl.	131,87 €/bl.	146,57 €/bl.

### COMPONENTES

**PERFIL 3, 4 Ó 5 VÍAS:** Terminales, perfiles portatelas, tapones portatelas, correderas, topes enlace "T" y "L", estribos techo, soportes para pared, tornillos y tacos, patín, tope portatela fijo, cordón, pletinas contrapeso 40x3, tapones pletinas, contrapeso 70 grs. y empalme (solo para 5 vías).

## PERFILES "PANEL JAPONÉS"

PERFIL 5 VÍAS

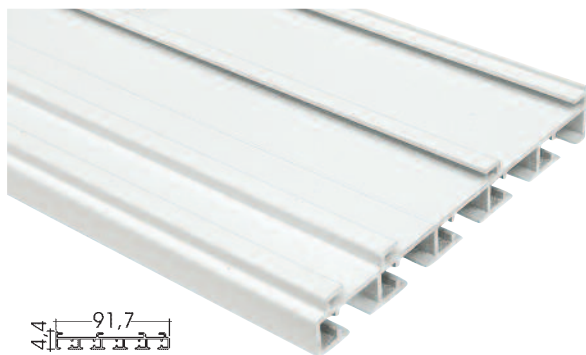

PERFIL 4 VÍAS

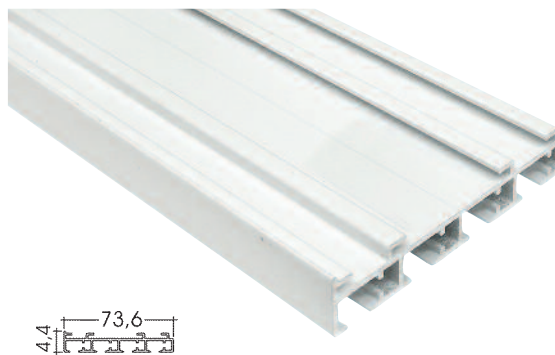

REF.	<---->		06	40
0932**0	6 m.	x 10	116,66 €/u.	129,52 €/u.
0939**0	4 m.	x 10	79,29 €/u.	87,23 €/u.

REF.	<---->		06	40
0931**0	6 m.	x 12	98,54 €/u.	109,00 €/u.
0938**0	4 m.	x 12	67,07 €/u.	76,16 €/u.

PERFIL 3 VÍAS



PERFIL 2 VÍAS



PERFIL PORTATELA

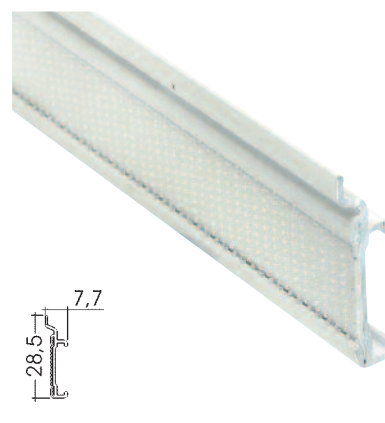

REF.	<---->	06	40
		x 12	x 12
0930**0	6 m.	71,76 €/u.	72,78 €/u.
0937**0	4 m.	52,35 €/u.	54,26 €/u.

REF.	<---->	06	40
		x 12	-
0929060	6 m.	51,39 €/u.	-
0936060	4 m.	35,64 €/u.	-

REF.	<---->	06	40
		x 20	x 20
0928**0	6 m.	32,12 €/u.	35,08 €/u.
0940**0	4 m.	26,48 €/u.	29,40 €/u.

\*\* Colores: 06= Blanco. 40= Plata.  
Código de envasado: 0= Granel. 2= Blister.

# ACCESORIOS

CORREDERA

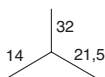
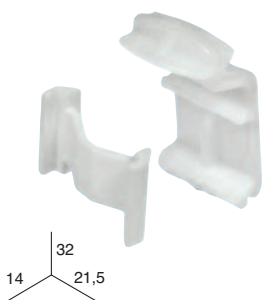

CORREDERA CON RUEDA

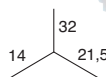
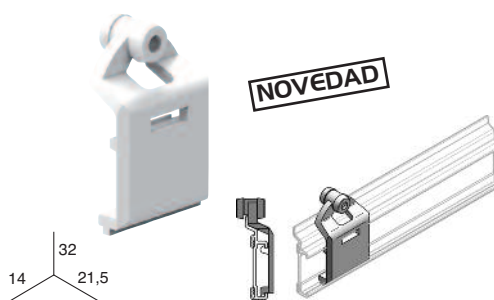

**NOVEDAD**

TAPÓN PORTATELA

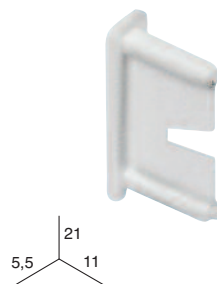

REF.	0959**0	7571**0	0941**0
------	---------	---------	---------

x 100

x 100

x 50



06 **0,24 €/u.**  
32 **0,24 €/u.**

**0,29 €/u.**  
**0,32 €/u.**

**1,74 €/Caja**  
**1,74 €/Caja**

JUEGO DE TAPÓN UNIVERSAL (IZQUIERDA-DERECHA)

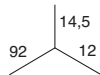

JUEGO DE TERMINAL 2 VÍAS (IZQUIERDA-DERECHA)

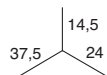

JUEGO DE TERMINAL 3 VÍAS (IZQUIERDA-DERECHA)

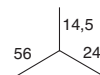
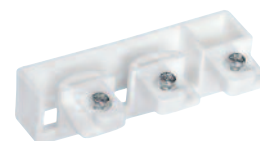

REF.	0922**0	0918060	0919**0
------	---------	---------	---------

x 10

x 10

x 10



06 **1,46 €/u.**  
32 **1,46 €/u.**

**0,79 €/u.**

**1,00 €/u.**  
**1,00 €/u.**

JUEGO DE TERMINAL 4 VÍAS (IZQUIERDA-DERECHA)

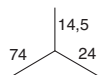

JUEGO DE TERMINAL 5 VÍAS (IZQUIERDA-DERECHA)

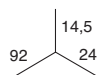

AESTRIBO CORTO 2 Y 3 VÍAS, FIJO

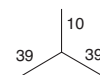

REF.	0920**0	0921**0	0925400
------	---------	---------	---------

x 10

x 10

x 25



06 **1,47 €/u.**  
32 **1,47 €/u.**

**1,73 €/u.**  
**1,73 €/u.**

40 **0,37 €/u.**

\*\* Colores: 06= Blanco. 32= Gris.  
Código de envasado: 0= Granel.





# ACCESORIOS

ESTRIBO LARGO 4 Y 5 VÍAS, FIJO

ESTRIBO CORTO 2 Y 3 VÍAS, AJUSTABLE

ESTRIBO LARGO 4 Y 5 VÍAS, AJUSTABLE

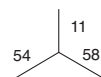
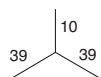
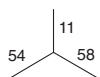

REF.	0927400	0948400	0949400
	x 25	x 25	x 25
40	0,41 €/u.	0,37 €/u.	0,39 €/u.

SOPORTE TECHO AUTOMÁTICO 2 Y 3 VÍAS

SOPORTE TECHO AUTOMÁTICO 4 Y 5 VÍAS

TOPE PORTATELA FIJO

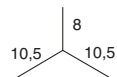
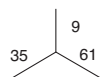
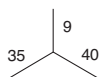

REF.	7474060	7475060	0917400
	x 25	x 25	x 100
06	1,00 €/u.	1,07 €/u.	40 0,35 €/u.

TOPE "L"

TOPE "T"

ENGANCHE PARA TIRADOR

PATÍN

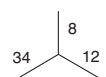
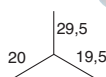
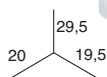
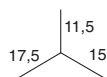

REF.	0923**0	0924**0	0935**0	0916**0
	x 50	x 50	x 50	x 25
06	0,21 €/u.	0,24 €/u.	0,37 €/u.	0,24 €/u.
32	0,21 €/u.	0,24 €/u.	0,37 €/u.	0,24 €/u.

\*\* Colores: 06= Blanco. 32= Gris.  
Código de envasado: 0= Granel.

# ACCESORIOS

CORDÓN POLIÉSTER Ø3



EMPALME PERFIL 2 Y 3 VÍAS

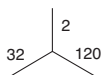

EMPALME PERFIL 4 Y 5 VÍAS

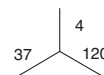
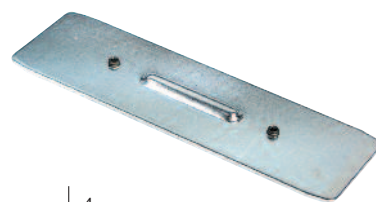

REF.	2553**0	0966400	0983400
	Carrete x 200 m.	x 10	x 10
	06 <b>28,08 €/Carrete</b>	-	-
	32 <b>28,08 €/Carrete</b>	-	-
	40 -	<b>1,62 €/u.</b>	<b>1,88 €/u.</b>

CONTRAPESO 70 grs.

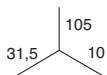

ARANDELA (PARA AJUSTAR ESTRIBO)



CINTA FELPA VELOUR SIN ADHESIVO (1)



20

REF.	1204**0	1863060	0991**0
	x 10	x 50	Carrete x 25 m.
	06 <b>1,24 €/u.</b>	<b>3,57 €/Caja</b>	<b>0,38 €/m.</b>
	07 -	-	<b>0,38 €/m.</b>
	32 <b>1,87 €/u.</b>	-	<b>0,38 €/m.</b>

CINTA FELPA LOOP SIN ADHESIVO (1)



20

PLETINA CONTRAPESO ALUMINIO  
24,5 mm. x 6 m.

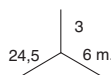

PLETINA CONTRAPESO ALUMINIO  
24,5 mm. x 4 m.

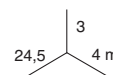

REF.	1698060	1075060	7274060
	Carrete x 25 m.	x 50	x 50
	06 <b>0,29 €/m.</b>	<b>22,20 €/u.</b>	<b>15,04 €/u.</b>

(1): La cinta **Loop** es para emparejar con la cinta **Hook**. La cinta **Velour** es para emparejar con la cinta **Setax**. Todos los perfiles velcrados Chyc van con cinta **Hook**. La cinta **Velour** se puede emparejar con la **Hook**, pero la cinta **Loop** no se puede emparejar con la **Setax**.

Colores: 06= Blanco. 07= Negro. 32= Gris. 40= Plata.  
Código de envasado: 0= Granel.



# ACCESORIOS

PLETINA CONTRAPESO ALUMINIO  
24,5 mm. x 3 m.

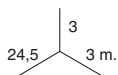

PLETINA CONTRAPESO ALUMINIO  
40 mm. x 6 m.

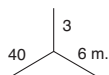

PLETINA CONTRAPESO ALUMINIO  
40 mm. x 4 m.

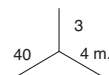

REF.	7300060	1079060	1100060
	x 50	x 50	x 50
06	11,20 €/u.	40,84 €/u.	27,72 €/u.

PLETINA CONTRAPESO TRANSPARENTE  
25 mm. x 3 m.

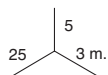

PLETINA CONTRAPESO TRANSPARENTE  
40 mm. x 3 m.

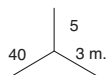

PLETINA CONTRAPESO POLIÉSTER  
30 mm. x 4 m.

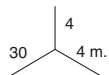
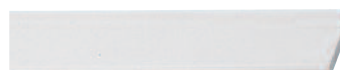

REF.	7344200	7346200	0828060
	x 50	x 50	x 50
06	-	-	12,79 €/u.
20	17,90 €/u.	23,80 €/u.	-

TAPÓN PLETINA 40 x 3 mm.

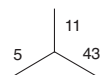

TAPÓN PLETINA 25 x 3 mm.

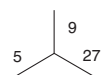

SOPORTE REFORZADO 9-12 cm.

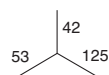

REF.	1779200	1772200	1817060
	x 50	x 50	x 20
06	-	-	1,05 €/u.
20	0,14 €/u.	0,08 €/u.	-

Colores: 06= Blanco. 20= Transparente.  
Código de envasado: 0= Granel.



# ACCESORIOS

SOPORTE DE PERFIL DE ALUMINIO 10 cm.

SOPORTE DE PERFIL DE ALUMINIO 15 cm.

SOPORTE DE PERFIL DE ALUMINIO 19 cm.

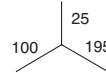
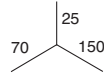
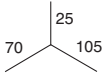

REF.	7199060	7229060	7230060
------	---------	---------	---------

x 50

x 50

x 25

06	1,45 €/u.	1,68 €/u.	1,94 €/u.
----	-----------	-----------	-----------

SOPORTE DE PERFIL DE ALUMINIO 24 cm.

SOPORTE DE PERFIL DE ALUMINIO 15 cm. BASE LARGA

SUPLEMENTO PARA SOPORTES

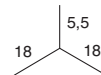
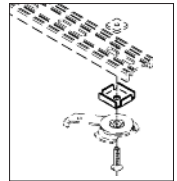
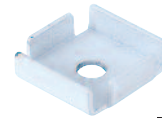
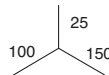
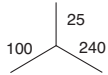

REF.	7231060	7226060	0898060
------	---------	---------	---------

x 25

x 25

x 25

06	2,17 €/u.	1,83 €/u.	3,40 €/Caja
----	-----------	-----------	-------------

SOPORTE DECO PARA PANEL JAPONÉS

**NOVEDAD**

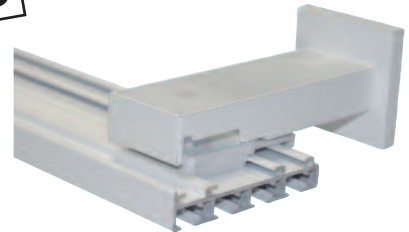
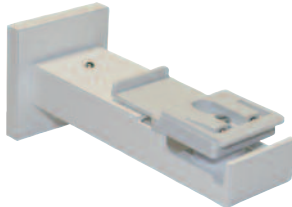
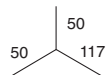

REF.	7570060
------	---------

x 1

06	11,09 €/u.
----	------------

TIRADORES (VER EN PÁGINAS 190 y 191)

Colores: **06**= Blanco.  
Código de envasado: **0**= Granel.



# ESTOR Y ACCESORIOS

## ESTOR CON VARILLAS PARA PANEL JAPONÉS

REF.	<---->	€
<b>7181060</b>	Hasta 0,90 m.	<b>8,87 €/u.</b>
<b>7182060</b>	A partir de 0,90 m.	<b>9,68 €/u.</b>

## ESTOR CON CINTA PAQUETO PARA PANEL JAPONÉS

REF.	<---->	€
<b>7184060</b>	Hasta 0,90 m.	<b>8,87 €/u.</b>
<b>7185060</b>	A partir de 0,90 m.	<b>9,68 €/u.</b>

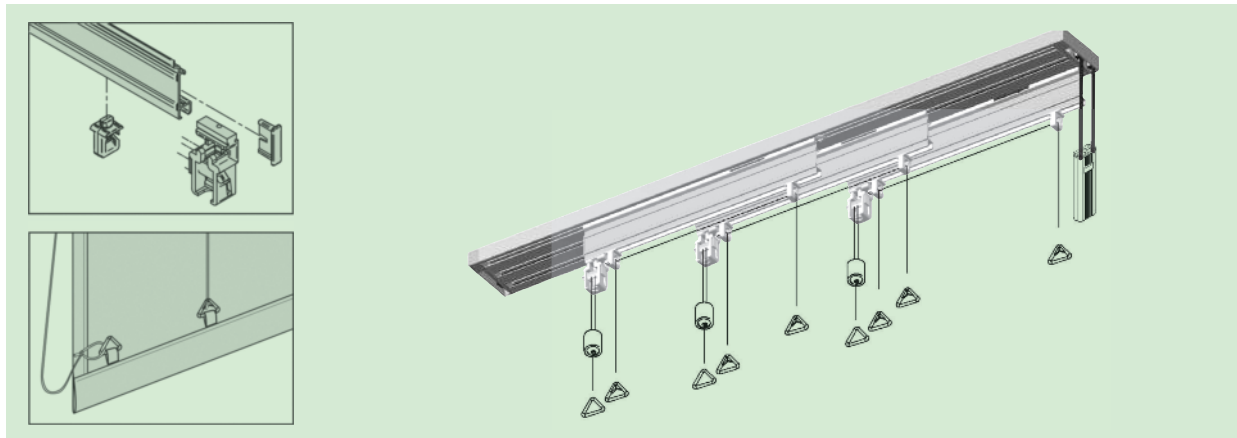

**NOTA:** para formular los pedidos de panel japonés con estor, anotar las referencias del panel y del estor, completando los detalles en la "HOJA DE PEDIDO" (Al final de la tarifa/catálogo)

PERFIL PORTATELA CON ESTOR,  
6 m.

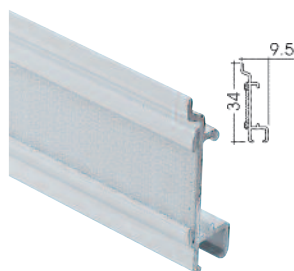

FRENA HILOS  
(se recomienda utilizar  
cordón fino ref. 1512060)

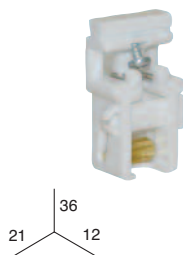

GUÍA HILOS



TAPÓN PORTATELA



REF.	1132**0	0876060	0863060	0941**0
	x 20	x 25	x 50	x 50
	06 <b>36,40 €/u.</b> 40 <b>45,49 €/u.</b>	<b>0,68 €/u.</b> -	<b>0,11 €/u.</b> -	06 <b>1,74 €/Caja</b> 32 <b>1,74 €/Caja</b>

UNIÓN HILOS-CORDÓN



ANILLA



ANILLA CON ENGANCHE



CORDÓN POLIÉSTER Ø1 (FINO)



REF.	1061060	0805**0	0845**0	1512060
	x 25	x 200	x 200	Carrete x 300 m.
	06 <b>2,91 €/Caja</b> 20 -	<b>5,62 €/Caja</b> <b>7,37 €/Caja</b>	<b>5,38 €/Caja</b> <b>7,83 €/Caja</b>	<b>29,20 €/Carrete</b> -

Colores: 06= Blanco. 20= Transparente. 32= Gris. 40= Plata.  
Código de envasado: 0= Granel.