



キウカレソ
フッキーア
ウョアオイ
オーイエウ
キケエソエ
コオケーオ
ガアツキ

Estores





CONJUNTO ESTOR COMPACTO PERFIL 7347, CON VARILLAS Y CINTA ESTOR

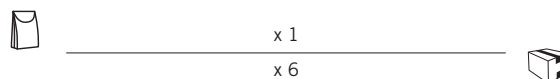
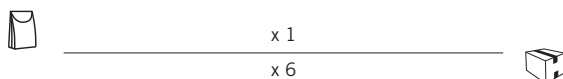

REF.	<---->	altura 1,80 m.	€/ Bolsa
7351064	0,60 x 1,80 m.	(2 soportes)	28,28 €/bs.
7352064	0,90 x 1,80 m.	(2 soportes)	34,72 €/bs.
7353064	1,20 x 1,80 m.	(2 soportes)	41,85 €/bs.
7354064	1,50 x 1,80 m.	(3 soportes)	50,38 €/bs.
7355064	1,80 x 1,80 m.	(3 soportes)	57,27 €/bs.
7356064	2,10 x 1,80 m.	(4 soportes)	63,60 €/bs.

REF.	<---->	altura 2,40 m.	€/ Bolsa
7360064	0,60 x 2,40 m.	(2 soportes)	29,43 €/bs.
7361064	0,90 x 2,40 m.	(2 soportes)	36,06 €/bs.
7362064	1,20 x 2,40 m.	(2 soportes)	43,12 €/bs.
7363064	1,50 x 2,40 m.	(3 soportes)	52,15 €/bs.
7364064	1,80 x 2,40 m.	(3 soportes)	59,09 €/bs.
7365064	2,10 x 2,40 m.	(4 soportes)	64,96 €/bs.

COMPONENTES: Perfil de aluminio, cinta felpa, cinta estor, carretes con cordón, freno con cadenilla, eje de aluminio, anillo para eje, pletina contrapeso 25x3, varilla de poliéster 4 mm., anillas final, soporte frente techo, tapones varillas, tapones pletina, tapones perfil, tope bola cadena, tacos, tornillos e instrucciones.

CONJUNTO ESTOR COMPACTO PERFIL 7347, CON CINTA PAQUETO

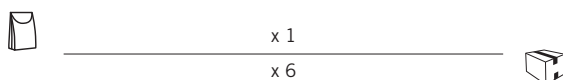

REF.	<---->	altura 2,40 m.	€/ Bolsa
7376064	0,60 x 2,40 m.	(2 soportes)	29,15 €/bs.
7377064	0,90 x 2,40 m.	(2 soportes)	35,69 €/bs.
7378064	1,20 x 2,40 m.	(2 soportes)	42,73 €/bs.
7379064	1,50 x 2,40 m.	(3 soportes)	51,62 €/bs.
7380064	1,80 x 2,40 m.	(3 soportes)	58,47 €/bs.
7381064	2,10 x 2,40 m.	(4 soportes)	64,31 €/bs.
7382064	2,40 x 2,40 m.	(4 soportes)	70,94 €/bs.
7383064	2,70 x 2,40 m.	(5 soportes)	77,37 €/bs.
7384064	3,00 x 2,40 m.	(5 soportes)	84,15 €/bs.

COMPONENTES: Perfil de aluminio, cinta felpa, cinta estor paquete, carretes con cordón, freno con cadenilla, eje de aluminio, anillo para eje, pletina contrapeso 25x3, anillas final, soportes frente techo, tapones pletina, tapones perfil, tope bola cadena, tacos, tornillos e instrucciones.

NOTA: disponemos de conjuntos de estor a medida y enrollables con textiles técnicos.

Colores: 06= Blanco.
Código de envasado: 4= Bolsa de protección.



PERFIL 7347 Y ACCESORIOS

PERFIL 7347

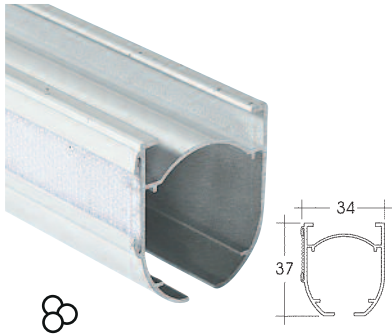

REF.

<---->



06

x 10

7348060 6 m. **58,45 €/u.**
7349060 4 m. **39,00 €/u.**

EJE DE ALUMINIO CUADRADO

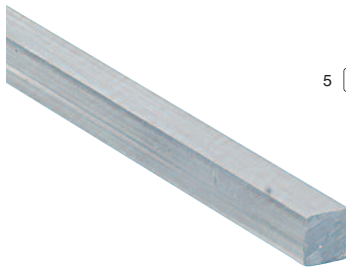

REF.

<---->



40

x 50

7343400 6 m. **8,78 €/u.**
7373400 4 m. **5,89 €/u.**

EJE DE ALUMINIO

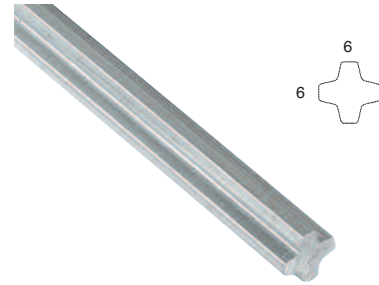

REF.

<---->



40

x 50

7265400 4 m. **4,72 €/u.**
7264400 3 m. **3,81 €/u.**

EMBRAGUE 1:2 + TAPÓN

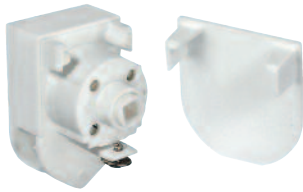

32 57
50

11,5 55
52

REF.

7369060

x 25

06

4,78 €/u.

EMBRAGUE 1:4 + TAPÓN

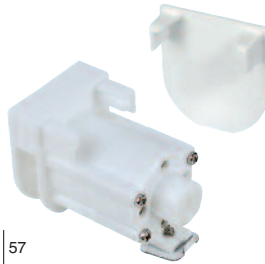

32 57
63

11,5 55
52

REF.

7350060

x 25

5,50 €/u.

EMBRAGUE 1:2 + TAPÓN CON CADENILLA

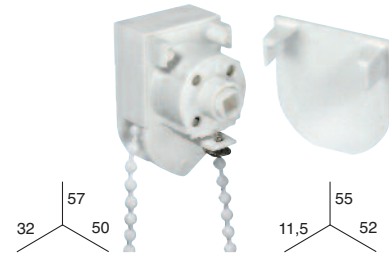

32 57
50

11,5 55
52

CADENILLA:
2,40 m. 3,00 m. 3,60 m.

REF.

7420060

x 25

6,10 €/u.

6,27 €/u.

6,45 €/u.

CARRETE CON CORDÓN DE 3,00 m.

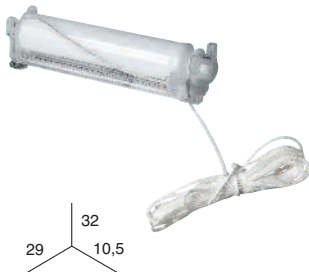

29 32
10,5

REF.

7370060

x 25

06

4,41 €/u.

SOPORTE FRENTE-TECHO



40 26,5
41

REF.

7371060

x 50

0,85 €/u.

SOPORTE FRENTE-TECHO AUTOMÁTICO

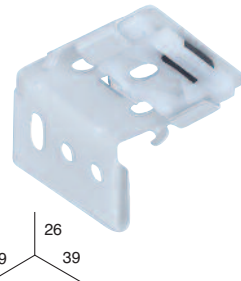

39 26
39

REF.

0498060

x 25

0,71 €/u.

SOPORTE TECHO AUTOMÁTICO



35 9
40

REF.

7474060

x 25

1,00 €/u.

Colores: 06= Blanco. 40= Plata.
Código de envasado: 0= Granel.

CONJUNTO ESTOR COMPACTO MOTORIZADO

NOVEDAD

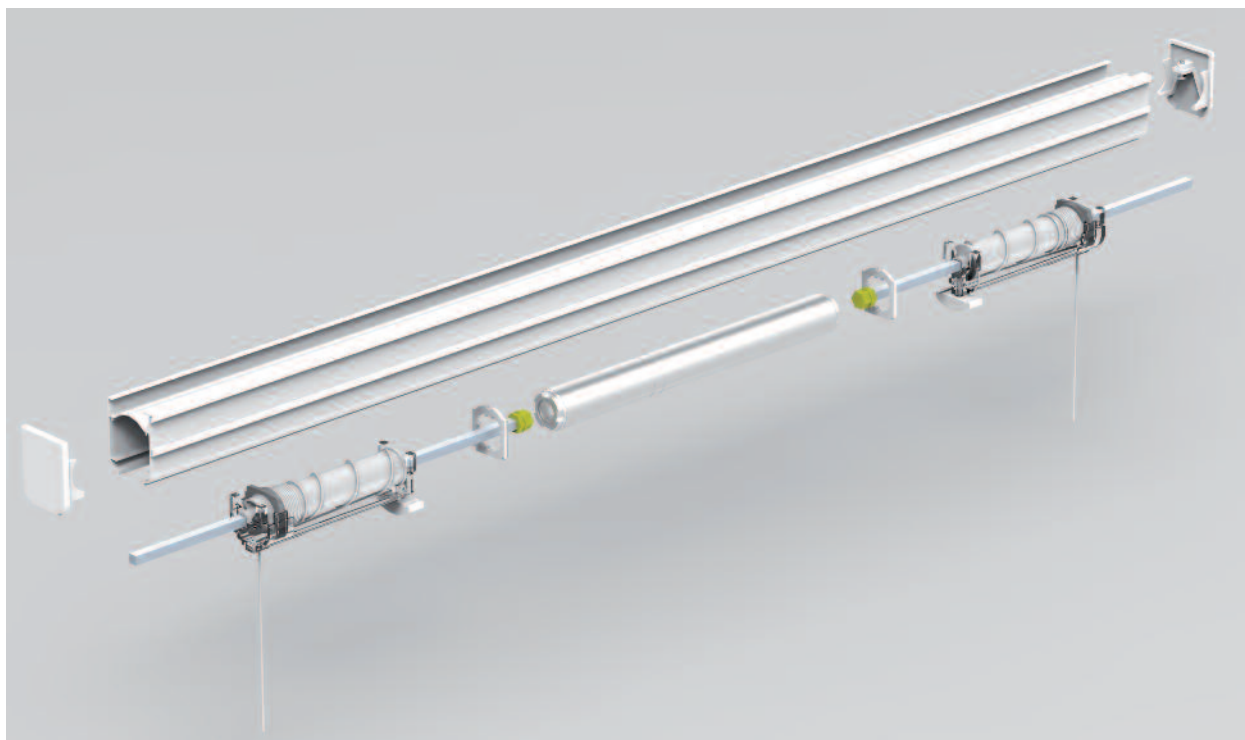

DISPONIBLE EN BREVE

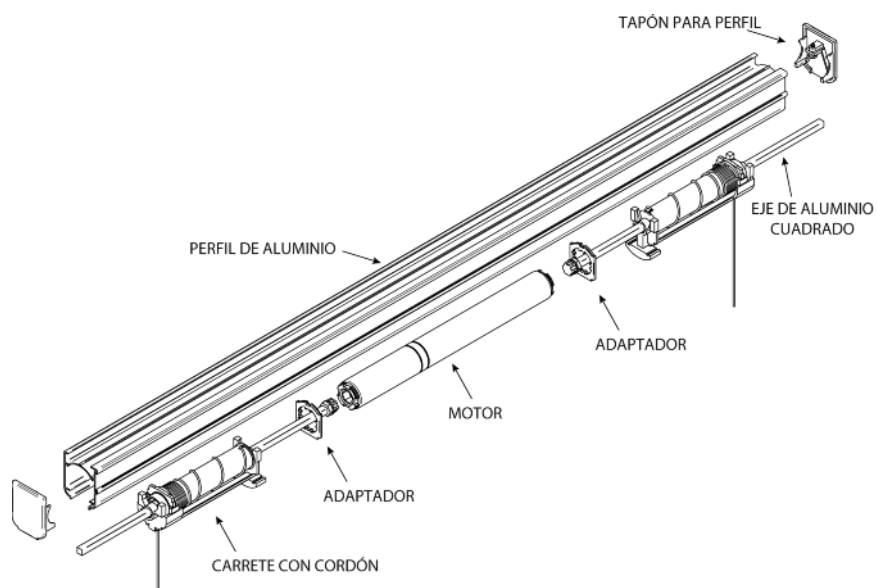
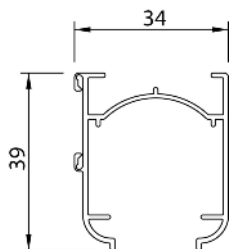



CONJUNTO ESTOR CON REDUCCIÓN RÁPIDA PERFIL 864, CON VARILLAS Y CINTA ESTOR

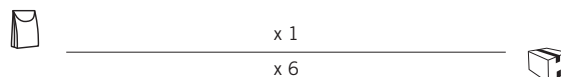
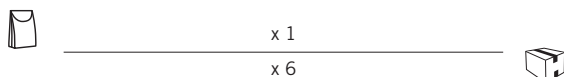

REF.	←----→ altura 1,80 m.	€/ Bolsa
2313064	0,60 x 1,80 m. (2 soportes)	29,91 €/bs.
2314064	0,90 x 1,80 m. (2 soportes)	33,63 €/bs.
2315064	1,20 x 1,80 m. (2 soportes)	38,03 €/bs.
2316064	1,50 x 1,80 m. (3 soportes)	47,57 €/bs.
2317064	1,80 x 1,80 m. (3 soportes)	52,04 €/bs.
2318064	2,10 x 1,80 m. (4 soportes)	62,12 €/bs.
2583064	2,40 x 1,80 m. (4 soportes)	66,51 €/bs.

REF.	←----→ altura 2,40 m.	€/ Bolsa
2319064	0,60 x 2,40 m. (2 soportes)	31,57 €/bs.
2320064	0,90 x 2,40 m. (2 soportes)	35,25 €/bs.
2321064	1,20 x 2,40 m. (2 soportes)	40,06 €/bs.
2322064	1,50 x 2,40 m. (3 soportes)	50,17 €/bs.
2323064	1,80 x 2,40 m. (3 soportes)	55,03 €/bs.
2324064	2,10 x 2,40 m. (4 soportes)	64,19 €/bs.
2325064	2,40 x 2,40 m. (4 soportes)	67,40 €/bs.

COMPONENTES: Perfil de aluminio, cinta felpa, cinta estor, carretes con cinta estor, freno con cadenilla, eje 4 vías de aluminio, pletina contrapeso 25x3, varilla de poliéster 4 mm., anillas final, soportes, enganche final cinta, tapones varillas, tapones pletina, tapones perfil, tacos, tornillos, llave Allen e instrucciones.

CONJUNTO ESTOR CON REDUCCIÓN RÁPIDA PERFIL 864, CON CINTA PAQUETO CON ANILLAS

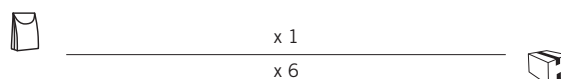
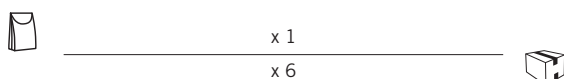

REF.	←----→ altura 1,80 m.	€/ Bolsa
2300064	0,60 x 1,80 m. (2 soportes)	33,02 €/bs.
2301064	0,90 x 1,80 m. (2 soportes)	36,26 €/bs.
2302064	1,20 x 1,80 m. (2 soportes)	39,63 €/bs.
2303064	1,50 x 1,80 m. (3 soportes)	51,14 €/bs.
2304064	1,80 x 1,80 m. (3 soportes)	54,57 €/bs.
2305064	2,10 x 1,80 m. (4 soportes)	65,14 €/bs.
2588064	2,40 x 1,80 m. (4 soportes)	69,57 €/bs.

REF.	←----→ altura 2,40 m.	€/ Bolsa
2306064	0,60 x 2,40 m. (2 soportes)	35,36 €/bs.
2307064	0,90 x 2,40 m. (2 soportes)	38,37 €/bs.
2308064	1,20 x 2,40 m. (2 soportes)	41,75 €/bs.
2309064	1,50 x 2,40 m. (3 soportes)	54,33 €/bs.
2310064	1,80 x 2,40 m. (3 soportes)	57,76 €/bs.
2311064	2,10 x 2,40 m. (4 soportes)	69,39 €/bs.
2312064	2,40 x 2,40 m. (4 soportes)	71,15 €/bs.

COMPONENTES: Perfil de aluminio, cinta felpa, carretes con cinta estor, freno con cadenilla, eje 4 vías de aluminio, pletina contrapeso 25x3, cinta paquete con anillas, anillas final, soportes, enganche final cinta, tapones pletina, tapones perfil, tacos, tornillos, llave Allen e instrucciones.

NOTA: disponemos de conjuntos de estor a medida y enrollables con textiles técnicos.

Colores: **06**= Blanco.
Código de envasado: **4**= Bolsa de protección.



PERFIL 864 Y ACCESORIOS

PERFIL 864

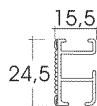
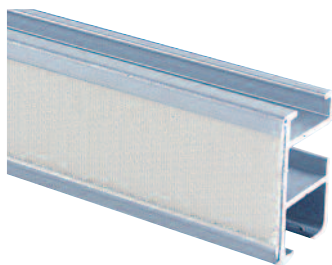

REF.	←-----→	06	40
------	---------	----	----



	x 40		
0864**0	6 m.	41,12 €/u.	38,64 €/u.
1099**0	4 m.	27,53 €/u.	25,87 €/u.
1098**0	3 m.	20,63 €/u.	19,36 €/u.
1097**0	2 m.	13,89 €/u.	13,01 €/u.

EJE DE ALUMINIO

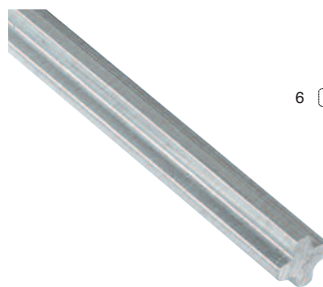

4,00 m. 3,00 m.

REF.	7265400	7264400	0993**0	0993**2
------	---------	---------	---------	---------



06	-	-	0,29 €/u.	1,80 €/bl.
07	-	-	0,35 €/u.	1,89 €/bl.
40	4,72 €/u.	3,81 €/u.	0,25 €/u.	1,71 €/bl.

SOPORTE TECHO CON ESTRIBO



CARRETE SIN CINTA (MÁX. 5 m.)

CARRETE CON CINTA DE 3 m.

FRENO SIN CADENILLA
(Máx. 2 kg. con 1783/ 1534)
(Máx. 4 kg. con 1677/ 1533)

FRENO CON CADENILLA
(MÁX. 4 Kg.)



LENTO (Blanco)

REF. 1677060



06 3,57 €/u.



LENTO (Blanco)

REF. 1533060



06 5,63 €/u.



FRENO SIN CADENILLA

REF. 1676060



06 3,00 €/u.



FRENO CON CADENILLA

REF. 1531060 1784060 1532060



06 5,08 €/u. 5,17 €/u. 5,39 €/u.

RÁPIDO (Rojo)

RÁPIDO (Rojo)

RÁPIDO (Rojo)

CADENILLA:

2,40 m. 3,00 m. 3,60 m.

SOPORTE FRENTE



REF. 1557060

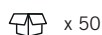

06 7,64 €/Caja

32 -

SOPORTE FRENTE-TECHO

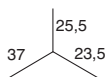

REF. 1509060

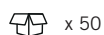

0,30 €/u.

-

SOPORTE FRENTE-TECHO



REF. 7499060



0,30 €/u.

-

TAPÓN ESTOR



REF. 1508**0



2,18 €/Caja

2,26 €/Caja

** Colores: 06= Blanco. 07= Negro. 32= Gris. 40= Plata.
Código de envasado: 0= Granel. 2= Blister.



CONJUNTO ESTOR PERFIL 7206, CON VARILLAS Y CINTA ESTOR

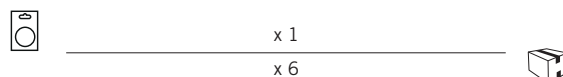
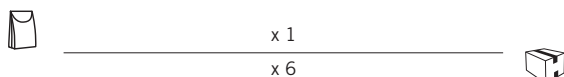

REF.	<---->	altura 1,80 m.	€/ Bolsa
1631064	0,60 x 1,80 m. (2 soportes)		20,53 €/bs.
1541064	0,90 x 1,80 m. (2 soportes)		26,08 €/bs.
1542064	1,20 x 1,80 m. (2 soportes)		30,32 €/bs.
1543064	1,50 x 1,80 m. (3 soportes)		36,27 €/bs.
1544064	1,80 x 1,80 m. (3 soportes)		41,39 €/bs.
1632064	2,10 x 1,80 m. (4 soportes)		45,61 €/bs.

REF.	<---->	altura 1,80 m.	€/ Blister
1541062	0,90 x 1,80 m. (2 soportes)		36,62 €/bl.
1542062	1,20 x 1,80 m. (2 soportes)		42,99 €/bl.
1543062	1,50 x 1,80 m. (3 soportes)		51,61 €/bl.
1544062	1,80 x 1,80 m. (3 soportes)		59,26 €/bl.

REF.	<---->	altura 2,40 m.	€/ Bolsa
1633064	0,60 x 2,40 m. (2 soportes)		21,72 €/bs.
1547064	0,90 x 2,40 m. (2 soportes)		28,38 €/bs.
1545064	1,20 x 2,40 m. (2 soportes)		32,97 €/bs.
1546064	1,50 x 2,40 m. (3 soportes)		40,01 €/bs.
1548064	1,80 x 2,40 m. (3 soportes)		45,16 €/bs.
1634064	2,10 x 2,40 m. (4 soportes)		49,96 €/bs.

REF.	<---->	altura 2,40 m.	€/ Blister
1547062	0,90 x 2,40 m. (2 soportes)		39,43 €/bl.
1545062	1,20 x 2,40 m. (2 soportes)		46,33 €/bl.
1546062	1,50 x 2,40 m. (3 soportes)		56,27 €/bl.
1548062	1,80 x 2,40 m. (3 soportes)		63,84 €/bl.

COMPONENTES: Anillas, cinta felpa, cinta estor, cadenilla, cinta estor para enrollar, carretes, soportes, tapones perfil, unión cadenilla, eje aluminio, brida eje, contrapeso aluminio, tapones contrapeso, freno cadenilla, perfil de aluminio, varilla de poliéster 4 mm., tapones varilla, tacos, tornillos e instrucciones.

CONJUNTO ESTOR PERFIL 7206, CON CINTA PAQUETO CON ANILLAS

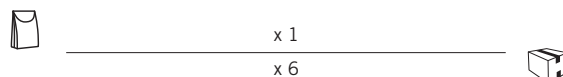
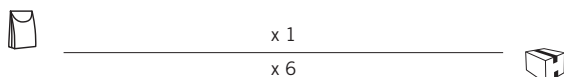

REF.	<---->	altura 1,80 m.	€/ Bolsa
2339064	0,60 x 1,80 m. (2 soportes)		23,35 €/bs.
2340064	0,90 x 1,80 m. (2 soportes)		26,10 €/bs.
2341064	1,20 x 1,80 m. (2 soportes)		29,33 €/bs.
2342064	1,50 x 1,80 m. (3 soportes)		36,28 €/bs.
2343064	1,80 x 1,80 m. (3 soportes)		39,87 €/bs.
2344064	2,10 x 1,80 m. (4 soportes)		47,56 €/bs.
2611064	2,40 x 1,80 m. (4 soportes)		51,43 €/bs.

REF.	<---->	altura 2,40 m.	€/ Bolsa
2345064	0,60 x 2,40 m. (2 soportes)		25,51 €/bs.
2346064	0,90 x 2,40 m. (2 soportes)		28,71 €/bs.
2347064	1,20 x 2,40 m. (2 soportes)		31,73 €/bs.
2348064	1,50 x 2,40 m. (3 soportes)		40,04 €/bs.
2349064	1,80 x 2,40 m. (3 soportes)		43,35 €/bs.
2350064	2,10 x 2,40 m. (4 soportes)		52,06 €/bs.
2351064	2,40 x 2,40 m. (4 soportes)		54,29 €/bs.

COMPONENTES: Anillas, cinta felpa, cinta paquete con anillas, cadenilla, cinta estor para enrollar, carretes, soportes, tapones perfil, unión cadenilla, eje de aluminio, brida eje, contrapeso aluminio, tapones contrapeso, freno cadenilla, perfil de aluminio, tacos, tornillos e instrucciones.

NOTA: disponemos de conjuntos de estor a medida y enrollables con textiles técnicos.

Colores: **06**= Blanco.
Código de envasado: **2**= Blister. **4**= Bolsa de protección.

PERFIL 7206 Y ACCESORIOS

PERFIL 7206

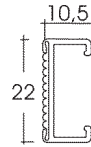

REF.	←----→	06
------	--------	----

x 50

7206060	6 m.	29,10 €/u.
7205060	4 m.	19,61 €/u.
7204060	3 m.	14,62 €/u.
7203060	2 m.	9,84 €/u.

EJE DE ALUMINIO

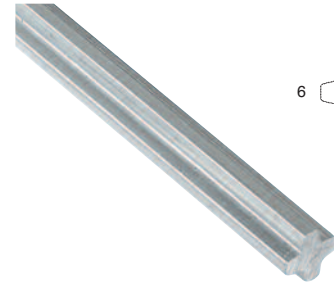

REF.	←----→	40
------	--------	----

x 50

7265400	4 m.	4,72 €/u.
7264400	3 m.	3,81 €/u.

CARRETE (Máx. 0,5 Kg./ 3 m.)

CARRETE CON CINTA 1,85 m.

CARRETE CON CINTA 2,45 m.

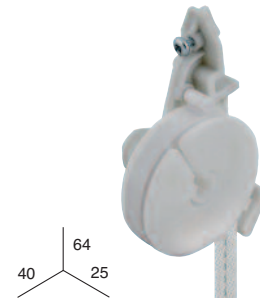
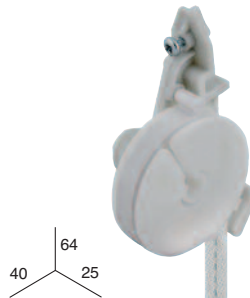

REF.	1536060	2217060	2218060
------	---------	---------	---------

x 25

x 25

x 25



06

0,58 €/u.

1,62 €/u.

1,75 €/u.

FRENO CADENILLA (Máx. 1,5 Kg.)

SOPORTE FRENTE TECHO

TAPÓN PERFIL

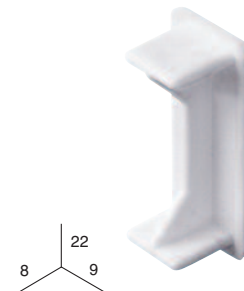
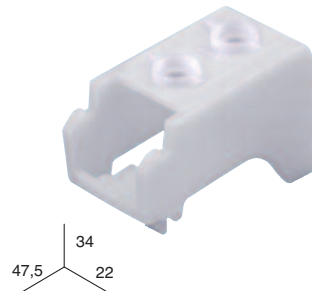
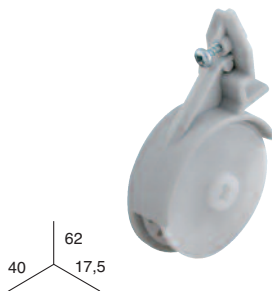

REF.	1538060	1540060	1521060
------	---------	---------	---------

x 25

x 25

x 50



06

0,99 €/u.

0,47 €/u.

2,49 €/Caja

** Colores: 06= Blanco. 40= Plata.
Código de envasado: 0= Granel.



CONJUNTO ESTOR CON REDUCCIÓN PERFIL 942, CON VARILLAS Y CINTA ESTOR

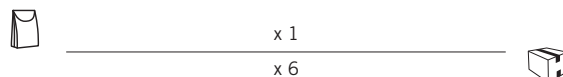
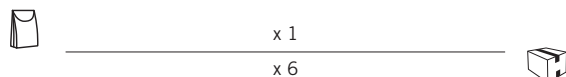

REF.	←----→ altura 1,80 m.	€/ Bolsa
2400064	0,60 x 1,80 m. (2 soportes)	25,83 €/bs.
2401064	0,90 x 1,80 m. (2 soportes)	29,75 €/bs.
2402064	1,20 x 1,80 m. (2 soportes)	34,01 €/bs.
2404064	1,50 x 1,80 m. (3 soportes)	42,24 €/bs.
2405064	1,80 x 1,80 m. (3 soportes)	45,07 €/bs.
2406064	2,10 x 1,80 m. (4 soportes)	52,12 €/bs.
2407064	2,40 x 1,80 m. (4 soportes)	54,31 €/bs.
2408064	2,70 x 1,80 m. (5 soportes)	63,51 €/bs.
2409064	3,00 x 1,80 m. (5 soportes)	67,27 €/bs.

REF.	←----→ altura 2,40 m.	€/ Bolsa
2410064	0,60 x 2,40 m. (2 soportes)	26,07 €/bs.
2411064	0,90 x 2,40 m. (2 soportes)	30,51 €/bs.
2412064	1,20 x 2,40 m. (2 soportes)	34,27 €/bs.
2413064	1,50 x 2,40 m. (3 soportes)	43,20 €/bs.
2414064	1,80 x 2,40 m. (3 soportes)	46,75 €/bs.
2415064	2,10 x 2,40 m. (4 soportes)	55,58 €/bs.
2416064	2,40 x 2,40 m. (4 soportes)	58,73 €/bs.
2417064	2,70 x 2,40 m. (5 soportes)	66,86 €/bs.
2418064	3,00 x 2,40 m. (5 soportes)	71,08 €/bs.

COMPONENTES: perfil de aluminio, anilla final, cinta felpa, cinta estor, soporte frente techo, freno con cadenilla, carrete con cinta, eje de aluminio, tacos, tornillos, contrapeso de aluminio, varillas de poliéster, tapón perfil, tapón varillas y tapones contrapeso.

CONJUNTO ESTOR CON REDUCCIÓN PERFIL 942, CON CINTA PAQUETO

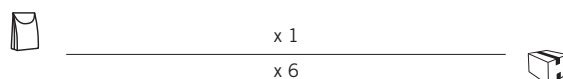
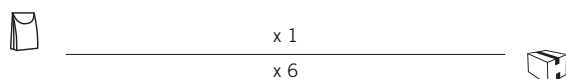

REF.	←----→ altura 1,80 m.	€/ Bolsa
2458064	0,60 x 1,80 m. (2 soportes)	29,85 €/bs.
2459064	0,90 x 1,80 m. (2 soportes)	32,94 €/bs.
2460064	1,20 x 1,80 m. (2 soportes)	36,55 €/bs.
2461064	1,50 x 1,80 m. (3 soportes)	46,69 €/bs.
2462064	1,80 x 1,80 m. (3 soportes)	50,15 €/bs.
2463064	2,10 x 1,80 m. (4 soportes)	60,43 €/bs.
2464064	2,40 x 1,80 m. (4 soportes)	62,26 €/bs.
2465064	2,70 x 1,80 m. (5 soportes)	73,14 €/bs.
2466064	3,00 x 1,80 m. (5 soportes)	76,44 €/bs.

REF.	←----→ altura 2,40 m.	€/ Bolsa
2467064	0,60 x 2,40 m. (2 soportes)	31,35 €/bs.
2468064	0,90 x 2,40 m. (2 soportes)	34,66 €/bs.
2469064	1,20 x 2,40 m. (2 soportes)	38,29 €/bs.
2470064	1,50 x 2,40 m. (3 soportes)	49,13 €/bs.
2471064	1,80 x 2,40 m. (3 soportes)	52,36 €/bs.
2472064	2,10 x 2,40 m. (4 soportes)	63,66 €/bs.
2473064	2,40 x 2,40 m. (4 soportes)	65,53 €/bs.
2474064	2,70 x 2,40 m. (5 soportes)	77,26 €/bs.
2475064	3,00 x 2,40 m. (5 soportes)	80,62 €/bs.

COMPONENTES: perfil de aluminio, anilla final, cinta felpa, cinta paquete, soporte frente techo, freno con cadenilla, carrete con cinta, eje de aluminio, tacos, tornillos, contrapeso de aluminio, tapón perfil y tapones contrapeso.

NOTA: disponemos de conjuntos de estor a medida y enrollables con textiles técnicos.

Colores: **06**= Blanco.
Código de envasado: **4**= Bolsa de protección.

PERFIL 942 Y ACCESORIOS

PERFIL 942

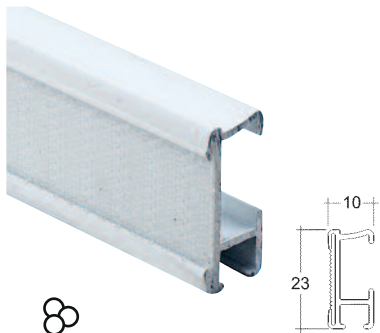

REF. 06

x 50

0942060	6 m.	31,80 €/u.
0894060	4 m.	21,22 €/u.

EJE DE ALUMINIO CUADRADO

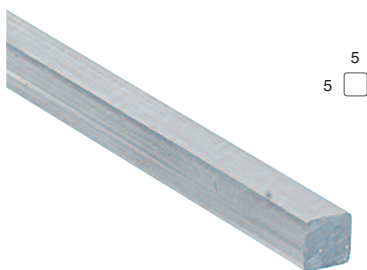

REF. 40

x 50

7343400	6 m.	8,78 €/u.
7373400	4 m.	5,89 €/u.

FRENO REDUCCIÓN CON CADENILLA

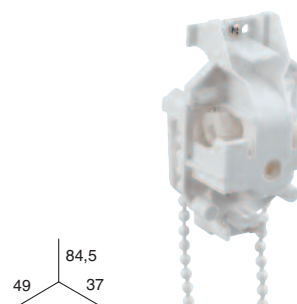

REF. CADENILLA 06

x 10

7339060	2,40 m.	5,84 €/u.
7340060	3,00 m.	6,45 €/u.
7341060	3,60 m.	7,02 €/u.

FRENO REDUCCIÓN SIN CADENILLA

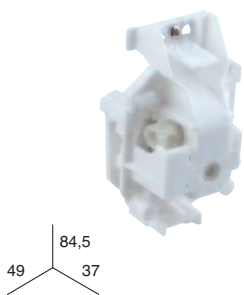

REF. 7398060

x 10

06	4,45 €/u.
20	-

CARRETE SIN CINTA

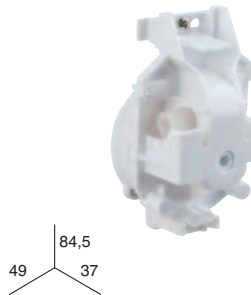

REF. 7342060

x 20

3,69 €/u.
-

CARRETE CON CINTA 2,40 m.

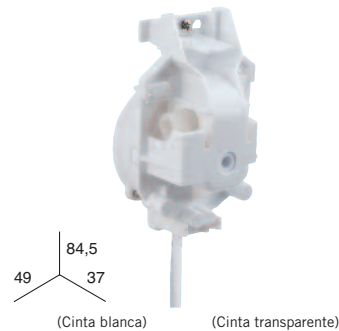

REF. 7399060 (Cinta blanca) 7399200 (Cinta transparente)

x 20 x 20

4,27 €/u.	-
-	4,76 €/u.

SOPORTE FRENTE TECHO

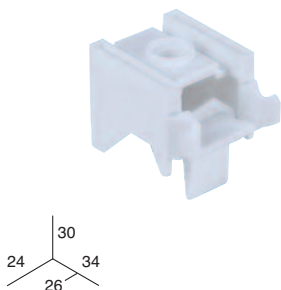

REF. 2219060

x 50

06	0,25 €/u.
----	-----------

SOPORTE FRENTE TECHO LARGO

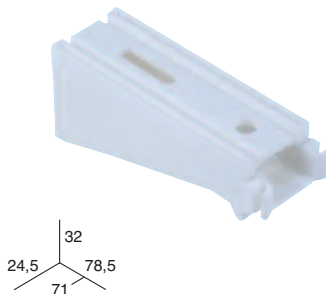

REF. 7372060

x 20

0,74 €/u.

TAPÓN PERFIL

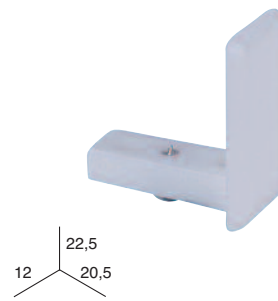

REF. 1945060

x 50

0,16 €/u.

** Colores: 06= Blanco. 20= Transparente. 40= Plata.
Código de envasado: 0= Granel.



ACCESORIOS ESTOR A CADENILLA

ANILLA

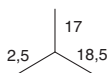

ANILLA CON ENGACHE

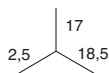

GANCHO FINAL PARA HILO ESTOR



ANILLA "S"

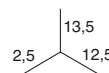

REF.	0805**0	0845**0	1074060	0843060
------	---------	---------	---------	---------

x 200

x 200

x 200

x 200

	06	5,62 €/Caja	5,38 €/Caja	5,66 €/Caja	3,70 €/Caja
	20	7,37 €/Caja	7,83 €/Caja	-	-

ANILLA TRANSPARENTE



ØINT. 6,5 ØINT. 9 ØINT. 10,5
ØEXT. 10 ØEXT. 13 ØEXT. 15,5

ANILLA CON BRIDA PARA VARILLA



ENGANCHE FINAL CINTA

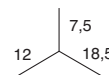
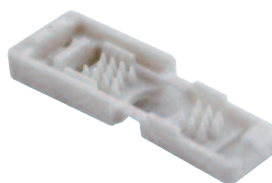

UNIÓN CADENILLA METÁLICA

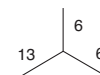

REF.	0798200	0842200	0793200	0844**0	1697060	1566**0
------	---------	---------	---------	---------	---------	---------

x 200

x 200

x 50

x 50

	06	-	-	5,36 €/Caja	5,88 €/Caja	43 8,45 €/Caja
	20	3,27 €/Cj.	3,84 €/Cj.	6,17 €/Cj.	8,72 €/Caja	44 8,82 €/Caja

ANILLO PARA EJE

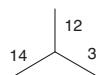

BRIDA EJE

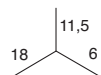

TOPE BOLA CADENA



CORDÓN POLIÉSTER



FINO Ø1 GRUESO Ø1,5

REF.	7802060	1539060	0866**0	1512060	0823060
------	---------	---------	---------	---------	---------

x 100

x 25

x 50

Carrete x 300 m.

	06	3,87 €/Caja	2,91 €/Caja	2,95 €/Caja	29,20 €/Carr.	32,84 €/Carr.
	20	-	-	2,95 €/Caja	-	-

** Colores: 06= Blanco. 20= Transparente. 43= Cromado. 44= Dorado.
Código de envasado: 0= Granel.

ACCESORIOS ESTOR A CADENILLA

UNIÓN CADENILLA

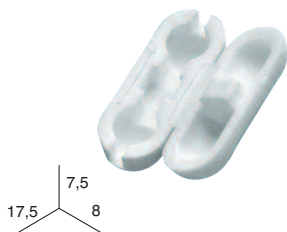

REF. 7259060

x 50

ÚTIL UNIR CADENILLA METÁLICA



REF. 1603000

x 1

ÚTIL UNIR CADENILLA PLÁSTICO



REF. 1769000

x 1



06

4,32 €/Caja

71,38 €/U. (Neto)

32,45 €/U. (Neto)

CADENILLA PASO 12



CADENILLA PASO 6

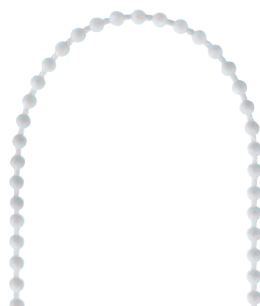

CADENILLA METÁLICA PASO 6



CADENILLA LATÓN PASO 6



REF. 1535060

Carrete x 250 m.

REF. 1650060

Carrete x 250 m.

REF. 1565**0

Carrete x 125 m.

REF. 2209**0

Carrete x 125 m.



06

0,55 €/m.

0,60 €/m.

-

-

44

-

-

2,06 €/m.

3,09 €/m.

43

-

-

1,04 €/m.

2,80 €/m.

CADENILLA SINFÍN PASO 6



REF.	<---->		06	43
2132060	1,50 m.	x 10	1,44 €/u.	-
2133060	2,00 m.	x 10	1,55 €/u.	-
1694**0	2,40 m.	x 10	1,69 €/u.	3,88 €/u.
1693**0	3,00 m.	x 10	1,83 €/u.	4,42 €/u.
1695**0	3,60 m.	x 10	1,94 €/u.	4,90 €/u.

** Colores: 06= Blanco. 43= Cromado. 44= Dorado.
Código de envasado: 0= Granel.



ACCESORIOS ESTOR A CADENILLA

PLETINA CONTRAPESO ALUMINIO 24,5 mm. (aconsejable para estor)

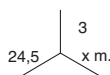

REF.	←----	06
		x 50
1075060	6,00 m.	22,20 €/u.
7274060	4,00 m.	15,04 €/u.
7300060	3,00 m.	11,20 €/u.

PLETINA CONTRAPESO ALUMINIO 40 mm. (aconsejable para panel japonés)

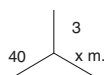

REF.	←----	06
		x 50
1079060	6,00 m.	40,84 €/u.
1100060	4,00 m.	27,72 €/u.
-	-	-

PLETINA CONTRAPESO POLIÉSTER 15 mm.

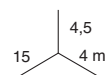

REF.	←----	06
		x 100
-	-	-
0827060	4,00 m.	11,49 €/u.
-	-	-

PLETINA CONTRAPESO POLIÉSTER 30 mm.

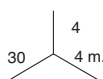

REF.	←----	06
		x 50
0828060	4,00 m.	12,79 €/u.
-	-	-

PLETINA CONTRAPESO TRANSPARENTE 24 mm. x 3 m. (aconsejable para estor)

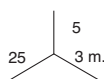

REF.	←----	20
		x 50
-	-	-
7344200	3,00 m.	17,90 €/u.

PLETINA CONTRAPESO TRANSPARENTE 40 mm. x 3 m. (aconsejable para panel japonés)

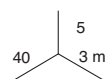

REF.	←----	20
		x 50
-	-	-
7346200	3,00 m.	23,80 €/u.

PLETINA CONTRAPESO PVC 25 mm.

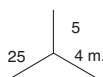

REF.	←----	06
		x 50
-	-	-
7491060	4,00 m.	8,38 €/u.
-	-	-

PLETINA CONTRAPESO PVC 40 mm.

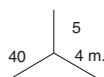

REF.	←----	06
		x 50
-	-	-
7492060	4,00 m.	13,49 €/u.
-	-	-

VARILLA DE POLIÉSTER Ø4 mm. (Bolsa de 100 U.)



REF.	←----	06
		x 500
1077060	6,00 m.	2,19 €/u.
0821060	4,00 m.	1,45 €/u.
0820060	3,00 m.	1,07 €/u.

** Colores: 06= Blanco. 20= Transparente. Código de envasado: 0= Granel.



ACCESORIOS ESTOR A CADENILLA

VARILLA TRANSPARENTE
Ø4,5 mm. x 3 m. (Bolsa de 100 U.)



TUBO CONTRAPESO
Ø12 mm. x 3 m.

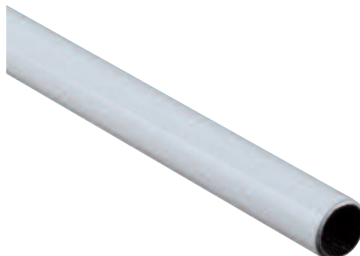

TAPÓN PLETINA 40 x 3



REF.	1213200	0427060	1779200
	x 100	x 14	x 50
	2,83 €/u.	7,33 €/u.	0,14 €/u.

TAPÓN PLETINA 25 x 3



TAPÓN VARILLA Ø4 mm.



TAPÓN TUBO Ø12 mm.



REF.	1772200	1699200	0804060
	x 50	x 200	x 50
	0,08 €/u.	4,65 €/Caja	1,98 €/Caja

CONTRAPESO PARA CADENILLA

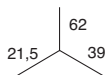

CONTRAPESO MINI PARA CADENILLA



TIJERA CORTAR VARILLA
POLIÉSTER Ø4 mm.



REF.	0497060	0490**0	7266070
	x 10	x 10	x 1
	0,95 €/u.	1,11 €/u. 1,38 €/u.	205,97 €/U. (Neto)

** Colores: **06**= Blanco. **20**= Transparente.
Código de envasado: **0**= Granel.



ACCESORIOS ESTOR A CADENILLA

CINTA ESTOR. Nº Bolsas: 1

CINTA ESTOR LISA

CINTA ESTOR CADENILLA

CINTA ESTOR TUBULAR.
Nº Bolsas: 1

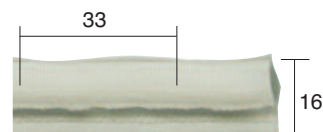
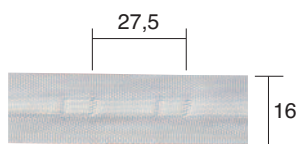

REF.	0053**0	0037**0	1662**0	0104**0
	Carrete x 300 m.	Carrete x 200 m.	Carrete x 200 m.	Carrete x 300 m.
06	0,23 €/m.	0,35 €/m.	0,19 €/m.	0,41 €/m.
20	0,33 €/m.	0,35 €/m.	0,20 €/m.	0,44 €/m.
21	0,24 €/m.	0,35 €/m.	-	0,41 €/m.

CINTA FELPA VELOUR
SIN ADHESIVO (1)

CINTA FELPA LOOP
SIN ADHESIVO (1)

CINTA ESTOR PAQUETO
(Utilizar solo para hilo)

CINTA ESTOR PAQUETO
CON ANILLAS

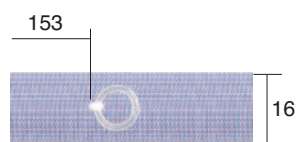
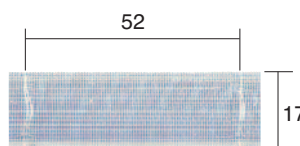

REF.	0991**0	1698060	0031200	0032200
	Carrete x 25 m.	Carrete x 25 m.	Carrete x 200 m.	Carrete x 150 m.
06	0,38 €/m.	0,29 €/m.	-	-
07	0,38 €/m.	-	-	-
20	-	-	0,43 €/m.	0,88 €/m.
32	0,38 €/m.	-	-	-

(1): La cinta **Loop** es para emparejar con la cinta **Hook**. La cinta **Velour** es para emparejar con la cinta **Setax**. Todos los perfiles velcrados Chyc van con cinta **Hook**. La cinta **Velour** se puede emparejar con la **Hook**, pero la cinta **Loop** no se puede emparejar con la **Setax**.

SOPORTE UNIVERSAL PARA VENTANAS

Ejemplo de aplicación:

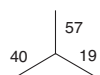

	0402**0	0402**2
	x 10	x 2
06	3,83 €/u.	10,61 €/bl.
07	3,93 €/u.	10,83 €/bl.
32	3,93 €/u.	10,83 €/bl.

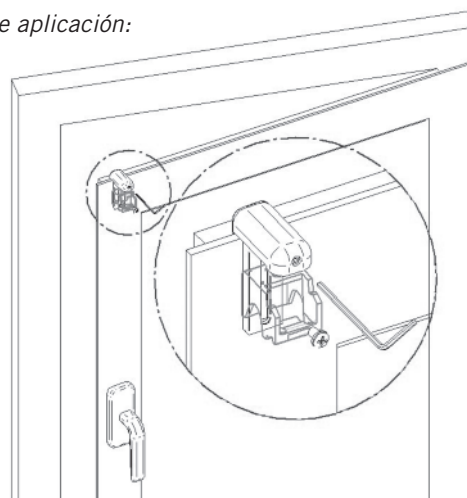

Nota: (espesor mínimo de la zona de anclaje 5 mm, espesor máximo 20 mm)

** Colores: 06= Blanco. 07= Negro. 32= Gris. 20= Transparente. 21= Beis.
Código de envasado: 0= Granel.

CONJUNTO ESTOR LAPA PERFIL 7393



CON VARILLAS Y CINTA ESTOR

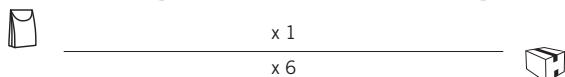

REF.	<----> altura 2,40 m.	€/ Bolsa
7401064	0,60 x 2,40 m. (2 soportes)	20,30 €/bs.
7402064	0,90 x 2,40 m. (2 soportes)	25,41 €/bs.
7403064	1,20 x 2,40 m. (2 soportes)	30,77 €/bs.
7404064	1,50 x 2,40 m. (3 soportes)	36,21 €/bs.
7405064	1,80 x 2,40 m. (3 soportes)	42,07 €/bs.
7406064	2,10 x 2,40 m. (4 soportes)	47,81 €/bs.
7407064	2,40 x 2,40 m. (4 soportes)	53,12 €/bs.
7408064	2,70 x 2,40 m. (5 soportes)	58,78 €/bs.
7409064	3,00 x 2,40 m. (5 soportes)	64,23 €/bs.

CON CINTA PAQUETO

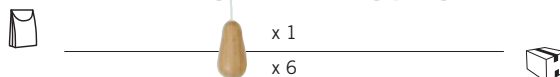

REF.	<----> altura 2,40 m.	€/ Bolsa
7410064	0,60 x 2,40 m. (2 soportes)	20,43 €/bs.
7411064	0,90 x 2,40 m. (2 soportes)	24,99 €/bs.
7412064	1,20 x 2,40 m. (2 soportes)	29,42 €/bs.
7413064	1,50 x 2,40 m. (3 soportes)	35,13 €/bs.
7414064	1,80 x 2,40 m. (3 soportes)	39,79 €/bs.
7415064	2,10 x 2,40 m. (4 soportes)	46,31 €/bs.
7416064	2,40 x 2,40 m. (4 soportes)	50,80 €/bs.
7417064	2,70 x 2,40 m. (5 soportes)	55,41 €/bs.
7418064	3,00 x 2,40 m. (5 soportes)	59,66 €/bs.

COMPONENTES: Perfil de aluminio, anilla final, cinta felpa, cinta estor, cordón, hilo estor, guía hilos, soportes, unión cordón, frena hilos, tacos, tornillos, contrapeso de aluminio, varillas poliéster 4 mm., tapón perfil, tapón varillas, tapones contrapeso y tirador de madera.

COMPONENTES: Perfil de aluminio, anilla final, cinta felpa, cinta paquete, cordón, hilo estor, guía hilos, soportes, unión cordón, frena hilos, tacos, tornillos, contrapeso de aluminio, tapón perfil, tapones contrapeso y tirador de madera.

CONJUNTO ESTOR "NOCHE Y DÍA" PERFIL 7393



CON VARILLAS Y CINTA ESTOR

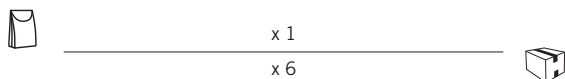

REF.	<----> altura 2,40 m.	€/ Bolsa
7118064	0,60 x 2,40 m. (2 soportes)	30,84 €/bs.
7119064	0,90 x 2,40 m. (2 soportes)	38,37 €/bs.
7122064	1,20 x 2,40 m. (2 soportes)	46,16 €/bs.
7123064	1,50 x 2,40 m. (3 soportes)	55,17 €/bs.
7126064	1,80 x 2,40 m. (3 soportes)	63,34 €/bs.
7130064	2,10 x 2,40 m. (4 soportes)	72,46 €/bs.
7131064	2,40 x 2,40 m. (4 soportes)	79,23 €/bs.
7139064	2,70 x 2,40 m. (5 soportes)	88,26 €/bs.
7140064	3,00 x 2,40 m. (5 soportes)	96,36 €/bs.

CON CINTA PAQUETO

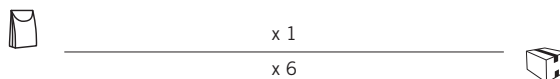

REF.	<----> altura 2,40 m.	€/ Bolsa
7141064	0,60 x 2,40 m. (2 soportes)	31,50 €/bs.
7142064	0,90 x 2,40 m. (2 soportes)	37,89 €/bs.
7149064	1,20 x 2,40 m. (2 soportes)	44,56 €/bs.
7150064	1,50 x 2,40 m. (3 soportes)	55,02 €/bs.
7156064	1,80 x 2,40 m. (3 soportes)	61,89 €/bs.
7157064	2,10 x 2,40 m. (4 soportes)	72,08 €/bs.
7158064	2,40 x 2,40 m. (4 soportes)	77,57 €/bs.
7159064	2,70 x 2,40 m. (5 soportes)	88,17 €/bs.
7160064	3,00 x 2,40 m. (5 soportes)	94,83 €/bs.

COMPONENTES: Perfil de aluminio, anilla final, cinta felpa, cinta estor, cordón, hilo estor, guía hilos, soportes, unión cordón, frena hilos, tacos, tornillos, contrapeso de aluminio, varillas poliéster 4 mm., tapón perfil, tapón varillas, tapones contrapeso y tirador de madera.

COMPONENTES: Perfil de aluminio, anilla final, cinta felpa, cinta paquete, cordón, hilo estor, guía hilos, soportes, unión cordón, frena hilos, tacos, tornillos, contrapeso de aluminio, tapón perfil, tapones contrapeso y tirador de madera.

NOTA: el estor "noche y día" trasero será siempre con varillas.

Colores: 06= Blanco.
Código de envasado: 4= Bolsa de protección.



PERFIL LAPA 7393 Y ACCESORIOS

PERFIL 7393

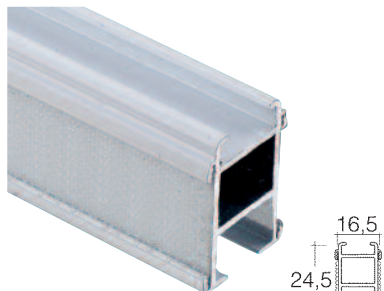

FRENA HILOS



GUÍA HILOS CON POLEA
(Para perfiles 7393 y 864)



REF.	←	→	06	REF.	1507060	1506060
7393060	6 m.	x 40	42,91 €/u.		x 25	x 50
7374060	4 m.	x 40	28,71 €/u.			
7375060	3 m.	x 40	27,48 €/u.	06	1,10 €/u.	0,24 €/u.

GUÍA HILO SIMPLE



CINTA FELPA VELOUR
CON ADHESIVO



TAPÓN ESTOR



SOPORTE TECHO CON ESTRIBO



REF.	1511060	1520**0	1508**0	0993**0	0993**2
	x 50	Carrete x 25 m.	x 50	x 50	x 2
06	0,17 €/u.	0,65 €/m.	2,18 €/Caja	0,29 €/u.	1,80 €/bl.
07	-	0,65 €/m.	-	0,35 €/u.	1,89 €/bl.
32	-	0,65 €/m.	2,26 €/Caja	-	-
40	-	-	-	0,25 €/u.	1,71 €/bl.

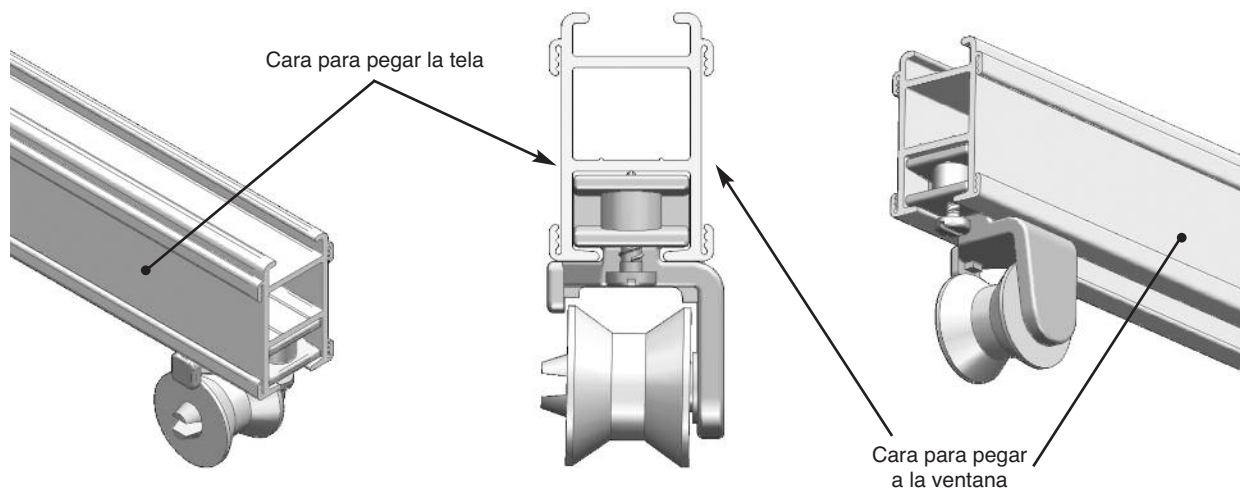

** Colores: 06= Blanco. 07= Negro. 32= Gris. 40= Plata.
Código de envasado: 0= Granel. 2= Blister.



CONJUNTO ESTOR PERFIL 864, CON VARILLAS Y CINTA ESTOR

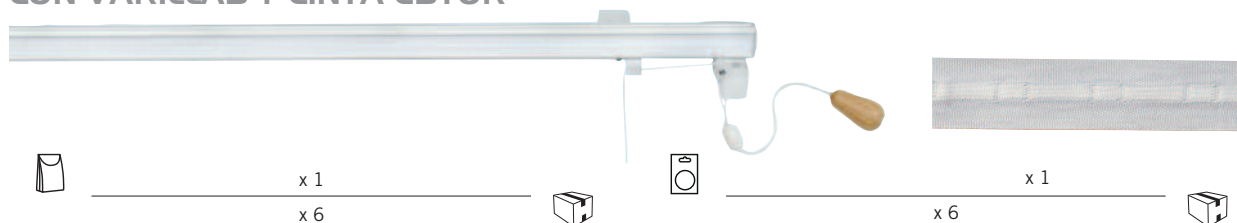

REF.	<---->	altura 1,80 m.	06	40
1549**4	0,60 x 1,80 m. (2 soportes)		18,52 €/bs.	18,25 €/bs.
1500**4	0,90 x 1,80 m. (2 soportes)		23,18 €/bs.	22,84 €/bs.
1501**4	1,20 x 1,80 m. (2 soportes)		27,95 €/bs.	27,45 €/bs.
1502**4	1,50 x 1,80 m. (3 soportes)		33,41 €/bs.	32,77 €/bs.
1503**4	1,80 x 1,80 m. (3 soportes)		38,20 €/bs.	37,46 €/bs.
1630**4	2,10 x 1,80 m. (4 soportes)		45,08 €/bs.	44,72 €/bs.

REF.	<---->	altura 1,80 m.	06	40
1549**2	0,60 x 1,80 m. (2 soportes)		24,28 €/bl.	23,97 €/bl.
1500**2	0,90 x 1,80 m. (2 soportes)		30,99 €/bl.	30,51 €/bl.
1501**2	1,20 x 1,80 m. (2 soportes)		37,50 €/bl.	36,90 €/bl.
1502**2	1,50 x 1,80 m. (3 soportes)		44,86 €/bl.	44,02 €/bl.
1503**2	1,80 x 1,80 m. (3 soportes)		51,42 €/bl.	50,44 €/bl.
-	-		-	-

REF.	<---->	altura 2,40 m.	06	40
1621**4	0,60 x 2,40 m. (2 soportes)		19,87 €/bs.	19,57 €/bs.
1556**4	0,90 x 2,40 m. (2 soportes)		24,80 €/bs.	24,40 €/bs.
1504**4	1,20 x 2,40 m. (2 soportes)		29,89 €/bs.	29,37 €/bs.
1505**4	1,50 x 2,40 m. (3 soportes)		34,80 €/bs.	35,19 €/bs.
1622**4	1,80 x 2,40 m. (3 soportes)		42,06 €/bs.	41,75 €/bs.
1550**4	2,10 x 2,40 m. (4 soportes)		47,19 €/bs.	46,29 €/bs.

REF.	<---->	altura 2,40 m.	06	40
-	-		-	-
1556**2	0,90 x 2,40 m. (2 soportes)		33,56 €/bl.	33,08 €/bl.
1504**2	1,20 x 2,40 m. (2 soportes)		39,88 €/bl.	39,25 €/bl.
1505**2	1,50 x 2,40 m. (3 soportes)		47,76 €/bl.	47,15 €/bl.
1622**2	1,80 x 2,40 m. (3 soportes)		52,22 €/bl.	51,18 €/bl.
1550**2	2,10 x 2,40 m. (4 soportes)		64,01 €/bl.	62,92 €/bl.

COMPONENTES: Perfil de aluminio, anilla final, cinta felpa, cinta estor, cordón, hilo estor, guía hilos, soportes, unión cordón, frena hilos, tacos, tornillos, contrapeso de aluminio, varillas poliéster 4 mm., tapón perfil, tapón varillas, tapones contrapeso y tirador de madera.

CONJUNTO ESTOR PERFIL 864, CON CINTA PAQUETO



CON CINTA PAQUETO

REF.	<---->	altura 1,80 m.	06
2326064	0,60 x 1,80 m. (2 soportes)		18,03 €/bs.
2327064	0,90 x 1,80 m. (2 soportes)		21,54 €/bs.
2328064	1,20 x 1,80 m. (2 soportes)		25,05 €/bs.
2329064	1,50 x 1,80 m. (3 soportes)		30,43 €/bs.
2330064	1,80 x 1,80 m. (3 soportes)		33,99 €/bs.
2331064	2,10 x 1,80 m. (4 soportes)		40,11 €/bs.
2578064	2,40 x 1,80 m. (4 soportes)		43,41 €/bs.
2579064	2,70 x 1,80 m. (5 soportes)		47,84 €/bs.
2580064	3,00 x 1,80 m. (5 soportes)		51,54 €/bs.

CON CINTA PAQUETO CON ANILLAS

REF.	<---->	altura 1,80 m.	06
2480064	0,60 x 1,80 m. (2 soportes)		20,19 €/bs.
2481064	0,90 x 1,80 m. (2 soportes)		24,80 €/bs.
2482064	1,20 x 1,80 m. (2 soportes)		29,49 €/bs.
2483064	1,50 x 1,80 m. (3 soportes)		33,49 €/bs.
2484064	1,80 x 1,80 m. (3 soportes)		38,01 €/bs.
2485064	2,10 x 1,80 m. (4 soportes)		43,32 €/bs.
2486064	2,40 x 1,80 m. (4 soportes)		48,00 €/bs.
2487064	2,70 x 1,80 m. (5 soportes)		52,66 €/bs.
2488064	3,00 x 1,80 m. (5 soportes)		57,20 €/bs.

REF.	<---->	altura 2,40 m.	06
2332064	0,60 x 2,40 m. (2 soportes)		18,92 €/bs.
2333064	0,90 x 2,40 m. (2 soportes)		22,50 €/bs.
2334064	1,20 x 2,40 m. (2 soportes)		26,00 €/bs.
2335064	1,50 x 2,40 m. (3 soportes)		31,84 €/bs.
2336064	1,80 x 2,40 m. (3 soportes)		35,34 €/bs.
2337064	2,10 x 2,40 m. (4 soportes)		41,79 €/bs.
2338064	2,40 x 2,40 m. (4 soportes)		44,71 €/bs.
2581064	2,70 x 2,40 m. (5 soportes)		49,14 €/bs.
2582064	3,00 x 2,40 m. (5 soportes)		52,94 €/bs.

REF.	<---->	altura 2,40 m.	06
2489064	0,60 x 2,40 m. (2 soportes)		21,26 €/bs.
2490064	0,90 x 2,40 m. (2 soportes)		25,87 €/bs.
2491064	1,20 x 2,40 m. (2 soportes)		30,53 €/bs.
2492064	1,50 x 2,40 m. (3 soportes)		34,54 €/bs.
2493064	1,80 x 2,40 m. (3 soportes)		39,12 €/bs.
2494064	2,10 x 2,40 m. (4 soportes)		44,39 €/bs.
2495064	2,40 x 2,40 m. (4 soportes)		49,04 €/bs.
2496064	2,70 x 2,40 m. (5 soportes)		53,75 €/bs.
2497064	3,00 x 2,40 m. (5 soportes)		58,29 €/bs.

COMPONENTES: Perfil de aluminio, anilla final, cinta felpa, cinta paquete (con o sin anillas), cordón, hilo estor, guía hilos, soportes, unión cordón, frena hilos, tacos, tornillos, contrapeso de aluminio, tapón perfil, tapones contrapeso y tirador de madera.

NOTA: disponemos de conjuntos de estor a medida y enrollables con textiles técnicos.

Colores: 06= Blanco. 40= Plata.
Código de envasado: 2= Blister. 4= Bolsa de protección.



PERFIL 864 Y ACCESORIOS

PERFIL 864

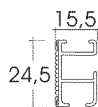
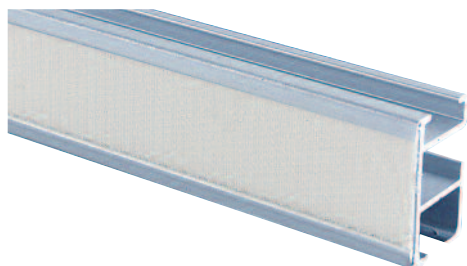

TAPÓN ESTOR



REF.	←----→	06	REF.	←----→	40	REF.	1508**0	
		x 40			x 40			x 50
0864060	6 m.	41,12 €/u.	0864400	6 m.	38,64 €/u.	06	2,18 €/Caja	
1099060	4 m.	27,53 €/u.	1099400	4 m.	25,87 €/u.	32	2,26 €/Caja	
1098060	3 m.	20,63 €/u.	1098400	3 m.	19,36 €/u.			
1097060	2 m.	13,89 €/u.	1097400	2 m.	13,01 €/u.			

FRENA HILOS

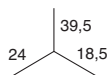

GUÍA HILOS CON POLEA
(Para perfil 864)



GUÍA HILOS SIMPLE

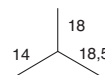

REF.	1507060	0825060	1511060	
		x 25		x 50
06	1,10 €/u.	0,26 €/u.	0,17 €/u.	

SOPORTE FRENTE

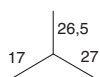
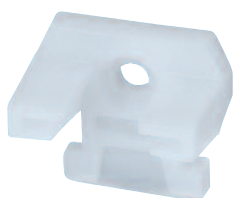

SOPORTE FRENTE-TECHO

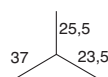

SOPORTE FRENTE-TECHO

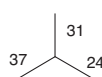

SOPORTE TECHO CON ESTRIBO



REF.	1557060	1509060	7499060	0993**0	0993**2	
		x 50		x 50		x 2
06	7,64 €/Caja	0,30 €/u.	0,30 €/u.	0,29 €/u.	1,80 €/bl.	
07	-	-	-	0,35 €/u.	1,89 €/bl.	
40	-	-	-	0,25 €/u.	1,71 €/bl.	

** Colores: 06= Blanco. 07= Negro. 32= Gris. 40= Plata.
Código de envasado: 0= Granel. 2= Blister.



CONJUNTO ESTOR PERFIL 7206, CON VARILLAS Y CINTA ESTOR



x 1

x 6



x 1

x 6



REF.	<---->	altura 1,80 m.	€/ Bolsa
1524064	0,90 x 1,80 m.	(2 soportes)	20,60 €/bs.
1525064	1,20 x 1,80 m.	(2 soportes)	25,08 €/bs.
1526064	1,50 x 1,80 m.	(3 soportes)	29,21 €/bs.
1527064	1,80 x 1,80 m.	(3 soportes)	33,97 €/bs.

REF.	<---->	altura 2,40 m.	€/ Bolsa
2599064	0,90 x 2,40 m.	(2 soportes)	21,78 €/bs.
1528064	1,20 x 2,40 m.	(2 soportes)	25,81 €/bs.
1529064	1,50 x 2,40 m.	(3 soportes)	31,00 €/bs.
2600064	1,80 x 2,40 m.	(3 soportes)	36,97 €/bs.

COMPONENTES: Perfil de aluminio, anilla final, cinta felpa, cinta estor, cordón, hilo estor, guía hilos, soportes, unión cordón, freno hilos, tacos, tornillos, contrapeso de aluminio, varillas poliéster 4 mm., tapón perfil, tapón varillas, tapones contrapeso y tirador de madera.

NOTA: disponemos de conjuntos de estor a medida y enrollables con textiles técnicos.

PERFIL 7206 Y ACCESORIOS

PERFIL 7206

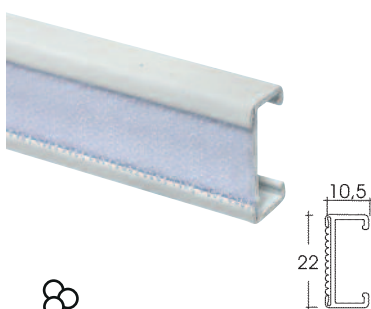

FRENA HILOS

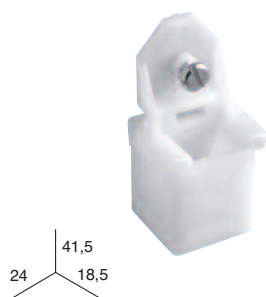

GUÍA HILOS



REF.	<---->	06
7206060	6 m.	x 50 29,10 €/u.
7205060	4 m.	x 50 19,61 €/u.
7204060	3 m.	x 50 14,62 €/u.
7203060	2 m.	x 50 9,84 €/u.

REF.	1523060	1522060
	x 25	x 50
06	0,69 €/u.	0,15 €/u.

SOPORTE ESTOR FRENTE-TECHO

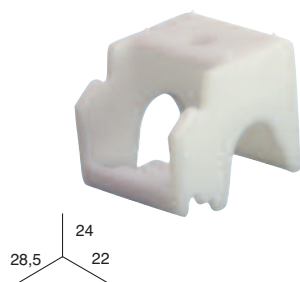

SOPORTE ESTOR FRENTE-TECHO LARGO

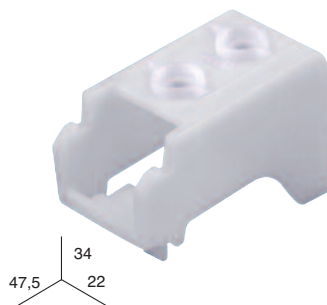

TAPÓN



REF.	7299060	1540060	1521060
	x 50	x 25	x 50
06	0,18 €/u.	0,47 €/u.	2,49 €/Caja

Colores: 06= Blanco.
Código de envasado: 0= Granel. 4= Bolsa de protección.



CONJUNTO ESTOR PERFIL 909, CON VARILLAS Y CINTA ESTOR



REF.	<---->	altura 1,80 m.	40	REF.	<---->	altura 2,40 m.	40
1513404	0,90 x 1,80 m.	(2 soportes)	20,25 €/bs.	2223404	0,90 x 2,40 m.	(2 soportes)	22,68 €/bs.
1514404	1,20 x 1,80 m.	(2 soportes)	24,36 €/bs.	1517404	1,20 x 2,40 m.	(2 soportes)	26,28 €/bs.
1515404	1,50 x 1,80 m.	(3 soportes)	29,27 €/bs.	1518404	1,50 x 2,40 m.	(3 soportes)	31,67 €/bs.
1516404	1,80 x 1,80 m.	(3 soportes)	33,44 €/bs.	2224404	1,80 x 2,40 m.	(3 soportes)	36,47 €/bs.

COMPONENTES: Perfil de aluminio, anilla final, cinta felpa, cinta estor, cordón, hilo estor, guía hilos, soportes, unión cordón, freno hilos, tacos, tornillos, contrapeso de aluminio, varillas poliéster 4 mm., tapón perfil, tapón varillas, tapones contrapeso y tirador de madera.

NOTA: disponemos de conjuntos de estor a medida y enrollables con textiles técnicos.

PERFIL 909 Y ACCESORIOS

PERFIL 909

EMPALME

FRENA HILOS (3 posiciones)

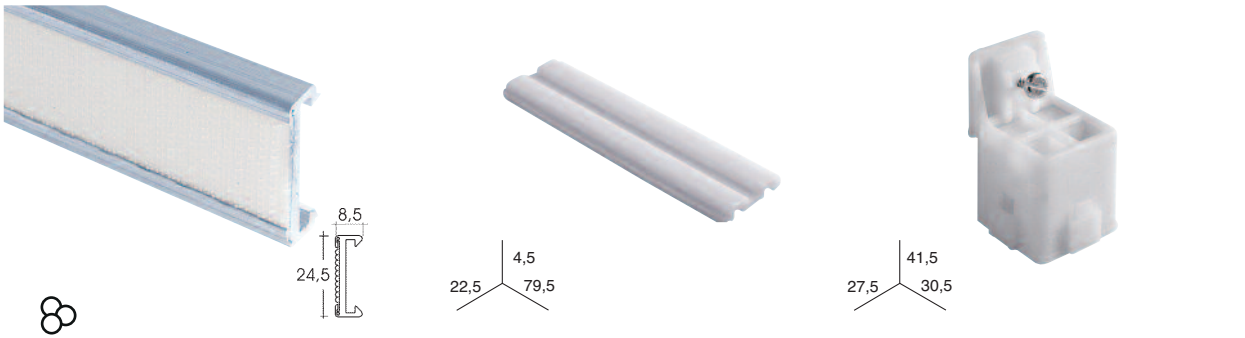

REF.	<---->	40	REF.	0824060	0802060
0909400	6 m. x 50	27,26 €/u.		x 25	x 25
1090400	4 m. x 50	18,21 €/u.			
1089400	3 m. x 50	13,67 €/u.	06	3,62 €/Caja	0,60 €/u.
1088400	2 m. x 50	9,15 €/u.			

GUÍA HILOS

SOPORTE ESTOR FRENTE-TECHO

ESTRIBO TECHO

TAPÓN ESTOR

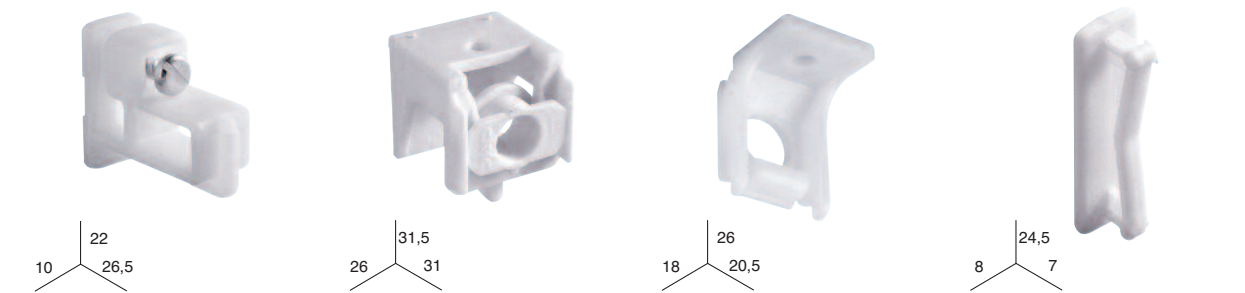

REF.	0803060	0800060	0990060	0801060
	x 50	x 50	x 50	x 50
06	0,20 €/u.	0,28 €/u.	5,69 €/Caja	2,05 €/Caja

** Colores: 06= Blanco. 40= Plata.
Código de envasado: 0= Granel. 4= Bolsa de protección.

CONJUNTO ESTOR PERFIL 942, CON VARILLAS Y CINTA ESTOR

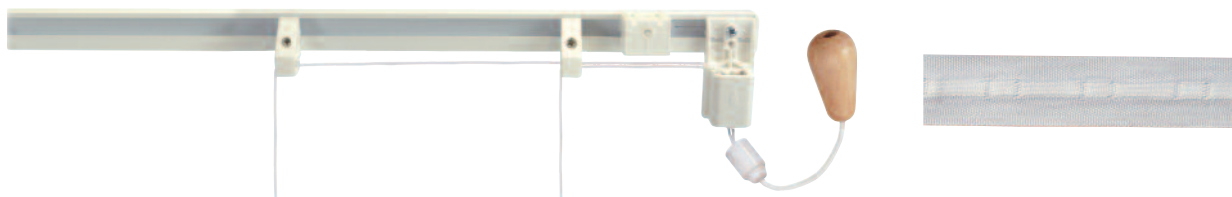

x 1
x 6



x 1
x 6



REF.	<----> altura 1,80 m.	€/ Bolsa
2380064	0,60 x 1,80 m. (2 soportes)	15,06 €/bs.
2381064	0,90 x 1,80 m. (2 soportes)	18,96 €/bs.
2382064	1,20 x 1,80 m. (2 soportes)	22,88 €/bs.
2384064	1,50 x 1,80 m. (3 soportes)	27,49 €/bs.
2385064	1,80 x 1,80 m. (3 soportes)	31,12 €/bs.
2386064	2,10 x 1,80 m. (4 soportes)	35,98 €/bs.
2387064	2,40 x 1,80 m. (4 soportes)	38,19 €/bs.
2388064	2,70 x 1,80 m. (5 soportes)	42,71 €/bs.
2389064	3,00 x 1,80 m. (5 soportes)	46,33 €/bs.

REF.	<----> altura 2,40 m.	€/ Bolsa
2390064	0,60 x 2,40 m. (2 soportes)	15,97 €/bs.
2391064	0,90 x 2,40 m. (2 soportes)	21,67 €/bs.
2392064	1,20 x 2,40 m. (2 soportes)	24,38 €/bs.
2393064	1,50 x 2,40 m. (3 soportes)	29,25 €/bs.
2394064	1,80 x 2,40 m. (3 soportes)	33,48 €/bs.
2395064	2,10 x 2,40 m. (4 soportes)	38,41 €/bs.
2396064	2,40 x 2,40 m. (4 soportes)	41,02 €/bs.
2397064	2,70 x 2,40 m. (5 soportes)	45,66 €/bs.
2398064	3,00 x 2,40 m. (5 soportes)	50,01 €/bs.

COMPONENTES: Perfil de aluminio, anilla final, cinta felpa, cinta estor, cordón, hilo estor, guía hilos, soportes, unión cordón, frena hilos, tacos, tornillos, contrapeso de aluminio, varillas poliéster 4 mm., tapón perfil, tapón varillas, tapones contrapeso y tirador de madera.

CONJUNTO ESTOR PERFIL 942, CON CINTA PAQUETO

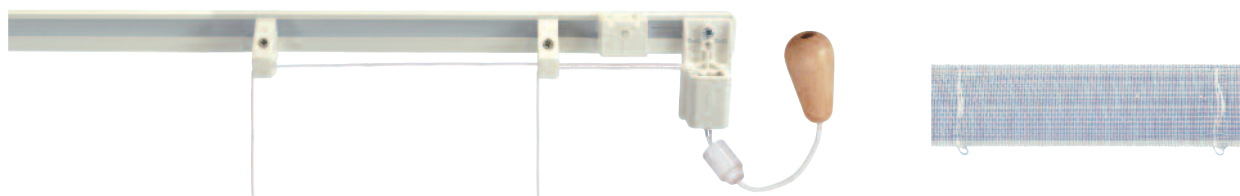

x 1
x 6



x 1
x 6



REF.	<----> altura 1,80 m.	€/ Bolsa
2440064	0,60 x 1,80 m. (2 soportes)	14,76 €/bs.
2441064	0,90 x 1,80 m. (2 soportes)	18,59 €/bs.
2442064	1,20 x 1,80 m. (2 soportes)	22,45 €/bs.
2443064	1,50 x 1,80 m. (3 soportes)	26,96 €/bs.
2444064	1,80 x 1,80 m. (3 soportes)	30,52 €/bs.
2445064	2,10 x 1,80 m. (4 soportes)	35,25 €/bs.
2446064	2,40 x 1,80 m. (4 soportes)	37,44 €/bs.
2447064	2,70 x 1,80 m. (5 soportes)	41,86 €/bs.
2448064	3,00 x 1,80 m. (5 soportes)	45,40 €/bs.

REF.	<----> altura 2,40 m.	€/ Bolsa
2449064	0,60 x 2,40 m. (2 soportes)	15,68 €/bs.
2450064	0,90 x 2,40 m. (2 soportes)	21,22 €/bs.
2451064	1,20 x 2,40 m. (2 soportes)	23,89 €/bs.
2452064	1,50 x 2,40 m. (3 soportes)	28,68 €/bs.
2453064	1,80 x 2,40 m. (3 soportes)	32,80 €/bs.
2454064	2,10 x 2,40 m. (4 soportes)	37,60 €/bs.
2455064	2,40 x 2,40 m. (4 soportes)	39,09 €/bs.
2456064	2,70 x 2,40 m. (5 soportes)	44,75 €/bs.
2457064	3,00 x 2,40 m. (5 soportes)	48,96 €/bs.

COMPONENTES: Perfil de aluminio, anilla final, cinta felpa, cinta paquete, cordón, hilo estor, guía hilos, soportes, unión cordón, frena hilos, tacos, tornillos, contrapeso de aluminio, tapón perfil, tapones contrapeso y tirador de madera.

NOTA: disponemos de conjuntos de estor a medida y enrollables con textiles técnicos.

Colores: 06= Blanco.
Código de envasado: 4= Bolsa de protección.



PERFIL 942 Y ACCESORIOS

PERFIL 942

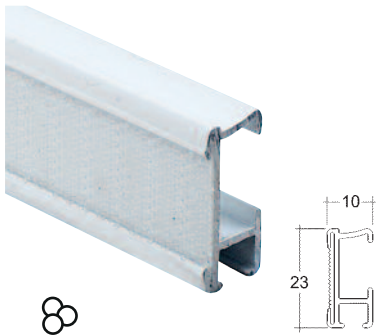

REF.



06

x 50

0942060

6 m.

31,80 €/u.

0894060

4 m.

21,22 €/u.

FRENA HILOS



REF.

1943060

x 25



06

1,01 €/u.

GUÍA HILOS

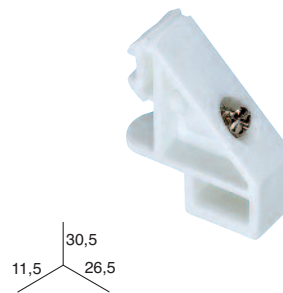

REF.

1944060

x 50

0,24 €/u.

SOPORTE FRENTE-TECHO

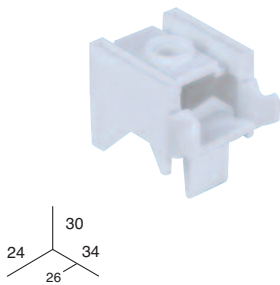

REF.

2219060

x 50



06

0,25 €/u.

SOPORTE FRENTE-TECHO LARGO

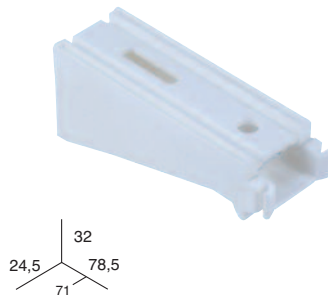

REF.

7372060

x 20

0,74 €/u.

TAPÓN PERFIL

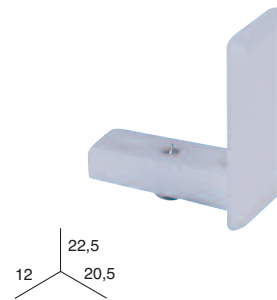

REF.

1945060

x 50

0,16 €/u.



CONJUNTO ESTOR PERFIL 950, PARA RIEL DE FORJA CHYC 28 mm.

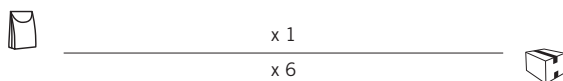

REF.	<----> altura 2,40 m.	06
2963064	1,20 x 2,40 m. (2 soportes)	26,75 €/bs.
2964064	1,50 x 2,40 m. (3 soportes)	30,68 €/bs.
2965064	1,80 x 2,40 m. (3 soportes)	34,83 €/bs.



EJEMPLO DE APLICACIÓN

COMPONENTES: Anillas, anillas final, cinta estor, cordón, hilo estor, guía hilos, bridas, llave hexagonal, tapones perfil, unión cordón, contrapeso aluminio, tapones contrapeso, frena hilos, perfil de aluminio, tirador de madera, varilla de poliéster 4 mm. y tapones varilla.

NOTA: disponemos de conjuntos de estor a medida y enrollables con textiles técnicos.

PERFIL 950 Y ACCESORIOS

PERFIL 950

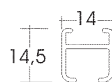
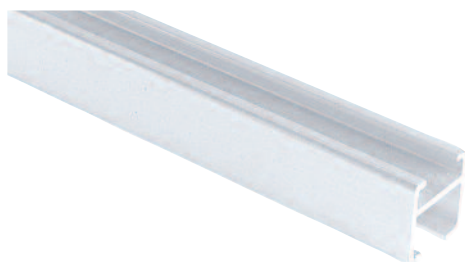

REF.	<---->	06	07	32
	x 40			
0950**0	6 m.	20,31 €/u.	21,32 €/u.	25,83 €/u.
1096**0	4 m.	13,58 €/u.	-	17,30 €/u.
1095**0	3 m.	10,22 €/u.	-	12,95 €/u.
1094**0	2 m.	6,80 €/u.	-	8,65 €/u.

BRIDA PARA SOPORTE FORJA



REF.	1562400
	x 50
40	22,92 €/Caja

FRENA HILOS

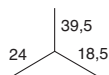

GUÍA HILOS

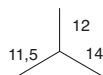

TAPÓN PERFIL

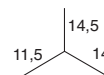

REF.	1507060	1560060	1561**0
	x 25	x 50	x 50
06	1,10 €/u.	6,23 €/Caja	2,66 €/Caja
20	-	-	2,66 €/Caja

** Colores: 06= Blanco. 07= Negro. 20= Transparente. 32= Gris.
Código de envasado: 0= Granel. 4= Bolsa de protección.



ACCESORIOS ESTOR A CORDÓN

ANILLA

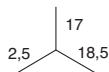

ANILLA CON ENGACHE

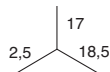

GANCHO FINAL PARA HILO ESTOR



ANILLA "S"

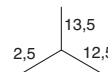

REF.	0805**0	0845**0	1074060	0843060
	x 200	x 200	x 200	x 200
06	5,62 €/Caja	5,38 €/Caja	5,66 €/Caja	3,70 €/Caja
20	7,37 €/Caja	7,83 €/Caja	-	-

ANILLA TRANSPARENTE

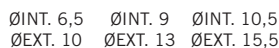
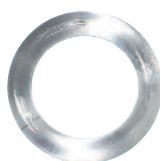

ANILLA CON BRIDA PARA VARILLA



UNIÓN HILOS CORDÓN



CORDÓN POLIÉSTER



REF.	0798200	0842200	0793200	0844**0	1061060	1512060	0823060
	x 200	x 200	x 200	x 200	x 25	Carrete x 300 m.	
06	-	-	-	5,36 €/Caja	2,91 €/Caja	29,20 €/Carr.	32,84 €/Carr.
20	3,27 €/Cj.	3,84 €/Cj.	6,17 €/Cj.	8,72 €/Caja	-	-	-

TIRADOR DE MADERA



TIRADOR DE PLÁSTICO



TIRADOR CAMPANA Ø4,2



TIRADOR CAMPANA Ø3



REF.	0807**0	0806060	0867060	0868060
	x 25	x 25	x 25	x 25
01	0,67 €/u.	-	-	-
02	0,67 €/u.	-	-	-
06	0,74 €/u.	3,23 €/Caja	1,55 €/Caja	1,56 €/Caja

** Colores: 01= Nogal. 02= Pino. 06= Blanco. 20= Transparente.
Código de envasado: 0= Granel.



ACCESORIOS ESTOR A CORDÓN

PLETINA CONTRAPESO
ALUMINIO 24,5 mm.
(aconsejable para estor)

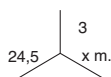

REF.	<---->	06
	x 50	
1075060	6,00 m.	22,20 €/u.
7274060	4,00 m.	15,04 €/u.
7300060	3,00 m.	11,20 €/u.

PLETINA CONTRAPESO
ALUMINIO 40 mm.
(aconsejable para panel japonés)

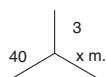

REF.	<---->	06
	x 50	
1079060	6,00 m.	40,84 €/u.
1100060	4,00 m.	27,72 €/u.
-	-	-

PLETINA CONTRAPESO
POLIÉSTER 15 mm.

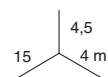

REF.	<---->	06
	x 100	
-	-	-
0827060	4,00 m.	11,49 €/u.
-	-	-

PLETINA CONTRAPESO
POLIÉSTER 30 mm.

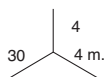

REF.	<---->	06
	x 50	
0828060	4,00 m.	12,79 €/u.
-	-	-

PLETINA CONTRAPESO
TRANSPARENTE 24 mm. x 3 m.
(aconsejable para estor)

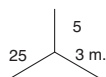

REF.	<---->	20
	x 50	
-	-	-
7344200	3,00 m.	17,90 €/u.

PLETINA CONTRAPESO
TRANSPARENTE 40 mm. x 3 m.
(aconsejable para panel japonés)

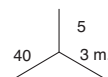

REF.	<---->	20
	x 50	
-	-	-
7346200	3,00 m.	23,80 €/u.

PLETINA CONTRAPESO
PVC 25 mm.

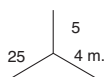

REF.	<---->	06
	x 50	
-	-	-
7491060	4,00 m.	8,38 €/u.
-	-	-

PLETINA CONTRAPESO
PVC 40 mm.

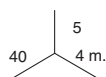

REF.	<---->	06
	x 50	
-	-	-
7492060	4,00 m.	13,49 €/u.
-	-	-

VARILLA DE POLIÉSTER
Ø4 mm. (Bolsa de 100 U.)



REF.	<---->	06
	x 500	
1077060	6,00 m.	2,19 €/u.
0821060	4,00 m.	1,45 €/u.
0820060	3,00 m.	1,07 €/u.

** Colores: 06= Blanco. 20= Transparente.
Código de envasado: 0= Granel.



ACCESORIOS ESTOR A CORDÓN

VARILLA TRANSPARENTE
Ø4,5 mm. x 3 m. (Bolsa de 100 U.)



TUBO CONTRAPESO
Ø12 mm. x 3 m.



TAPÓN PLETINA 40 x 3



REF.	1213200	0427060	1779200
	x 100	x 14	x 50
	2,83 €/u.	7,33 €/u.	0,14 €/u.

TAPÓN PLETINA 25 x 3



TAPÓN VARILLA Ø4 mm.



TAPÓN TUBO Ø12 mm.



REF.	1772200	1699200	0804060
	x 50	x 200	x 50
	0,08 €/u.	4,65 €/Caja	1,98 €/Caja

TIJERA CORTAR VARILLA
POLIÉSTER Ø4 mm.



REF.	7266070
	x 1
	205,97 €/u. (Neto)

** Colores: **06**= Blanco. **20**= Transparente.
Código de envasado: **0**= Granel.



ACCESORIOS ESTOR A CORDÓN

CINTA ESTOR. Nº Bolsas: 1

CINTA ESTOR LISA

CINTA ESTOR CADENILLA

CINTA ESTOR TUBULAR.
Nº Bolsas: 1

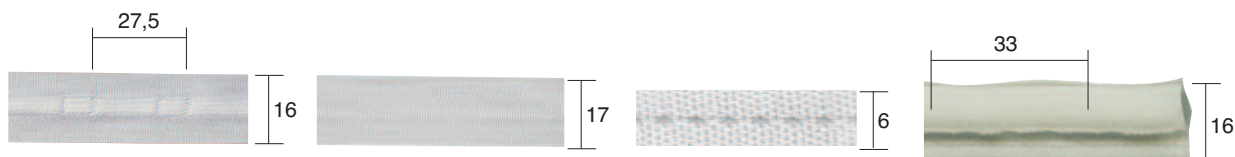

REF.	0053**0	0037**0	1662**0	0104**0
	Carrete x 300 m.	Carrete x 200 m.	Carrete x 200 m.	Carrete x 300 m.
06	0,23 €/m.	0,35 €/m.	0,19 €/m.	0,41 €/m.
20	0,33 €/m.	0,35 €/m.	0,20 €/m.	0,44 €/m.
21	0,24 €/m.	0,35 €/m.	-	0,41 €/m.

CINTA FELPA VELOUR
SIN ADHESIVO (1)

CINTA FELPA LOOP
SIN ADHESIVO (1)

CINTA ESTOR PAQUETO
(Utilizar solo para hilo)

CINTA ESTOR PAQUETO
CON ANILLAS

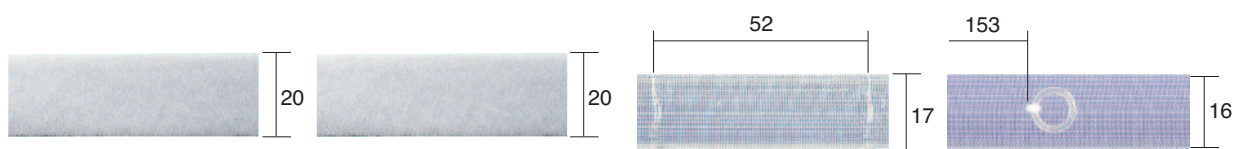

REF.	0991**0	1698060	0031200	0032200
	Carrete x 25 m.	Carrete x 25 m.	Carrete x 200 m.	Carrete x 150 m.
06	0,38 €/m.	0,29 €/m.	-	-
07	0,38 €/m.	-	-	-
20	-	-	0,43 €/m.	0,88 €/m.
32	0,38 €/m.	-	-	-

(1): La cinta **Loop** es para emparejar con la cinta **Hook**. La cinta **Velour** es para emparejar con la cinta **Setax**. Todos los perfiles velcrados Chyc van con cinta **Hook**. La cinta **Velour** se puede emparejar con la **Hook**, pero la cinta **Loop** no se puede emparejar con la **Setax**.

SOPORTE UNIVERSAL PARA VENTANAS

Ejemplo de aplicación:

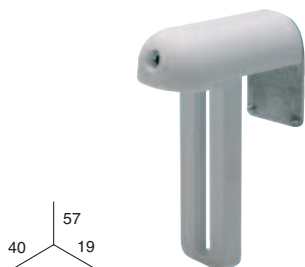

	0402**0	0402**2
	x 10	x 2
06	3,83 €/u.	10,61 €/bl.
07	3,93 €/u.	10,83 €/bl.
32	3,93 €/u.	10,83 €/bl.

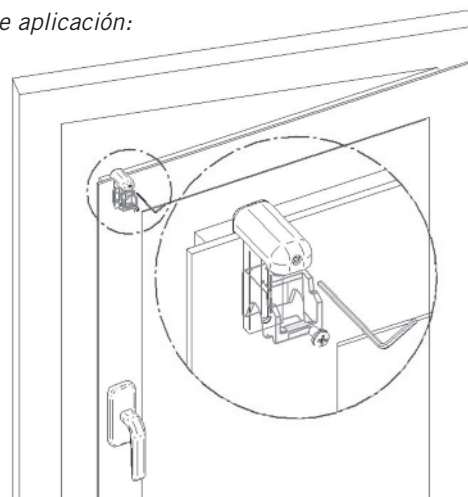

Nota: (espesor mínimo de la zona de anclaje 5 mm, espesor máximo 20 mm)

** Colores: 06= Blanco. 07= Negro. 32= Gris. 20= Transparente. 21= Beis.
Código de envasado: 0= Granel. 2= Blister.

DISPOSITIVOS DE SEGURIDAD INFANTIL

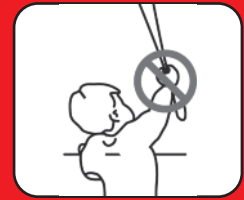

La comisión europea ha revisado recientemente la **norma EN 13120** de seguridad infantil en estores y cortinas. Esta nueva norma obliga a vender e instalar productos seguros que eviten accidentes.

El ámbito de aplicación son hogares, edificios públicos y la mayor parte de los edificios comerciales.

La norma va dirigida a evitar posibles accidentes en niños, (liarse con un cordón o cadeneta y como consecuencia de ello sufrir daños que en ocasiones pueden ser irreparables).

Las cortinas y estores deben ser instalados con dispositivos que cumplan el objetivo descrito.

Las instrucciones deben quedar claras cuando se vende/ instala el producto.

Se deben dar las instrucciones oportunas al usuario de dichas instalaciones.

NUESTROS DISPOSITIVOS DE SEGURIDAD

- 1.- Dispositivo de ruptura de cadenilla.
- 2.- Dispositivo simple de retención permanente.
- 3.- Dispositivo de rotura de cinta.
- 4.- Dispositivo de rotura de gancho final.

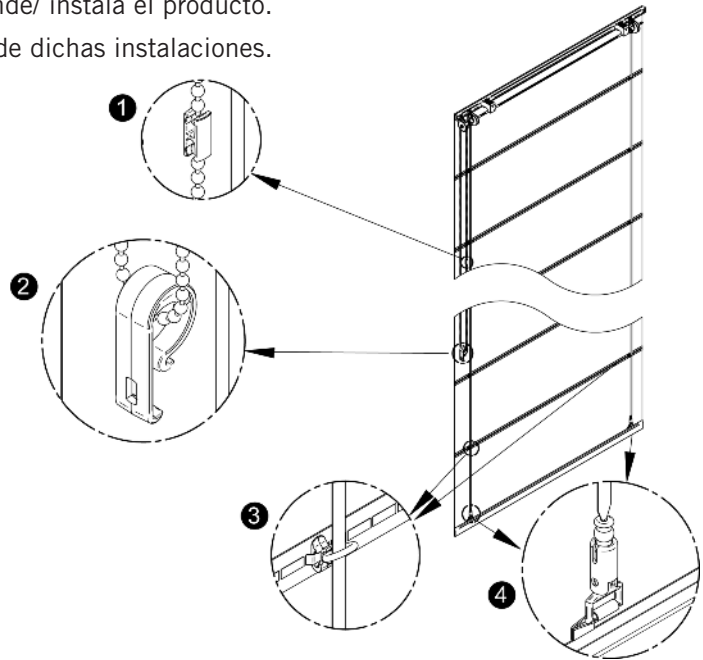

LONGITUDES MÁXIMAS DE CORDÓN Y CADENA CUANDO SE CONOCE LA ALTURA DE INSTALACIÓN

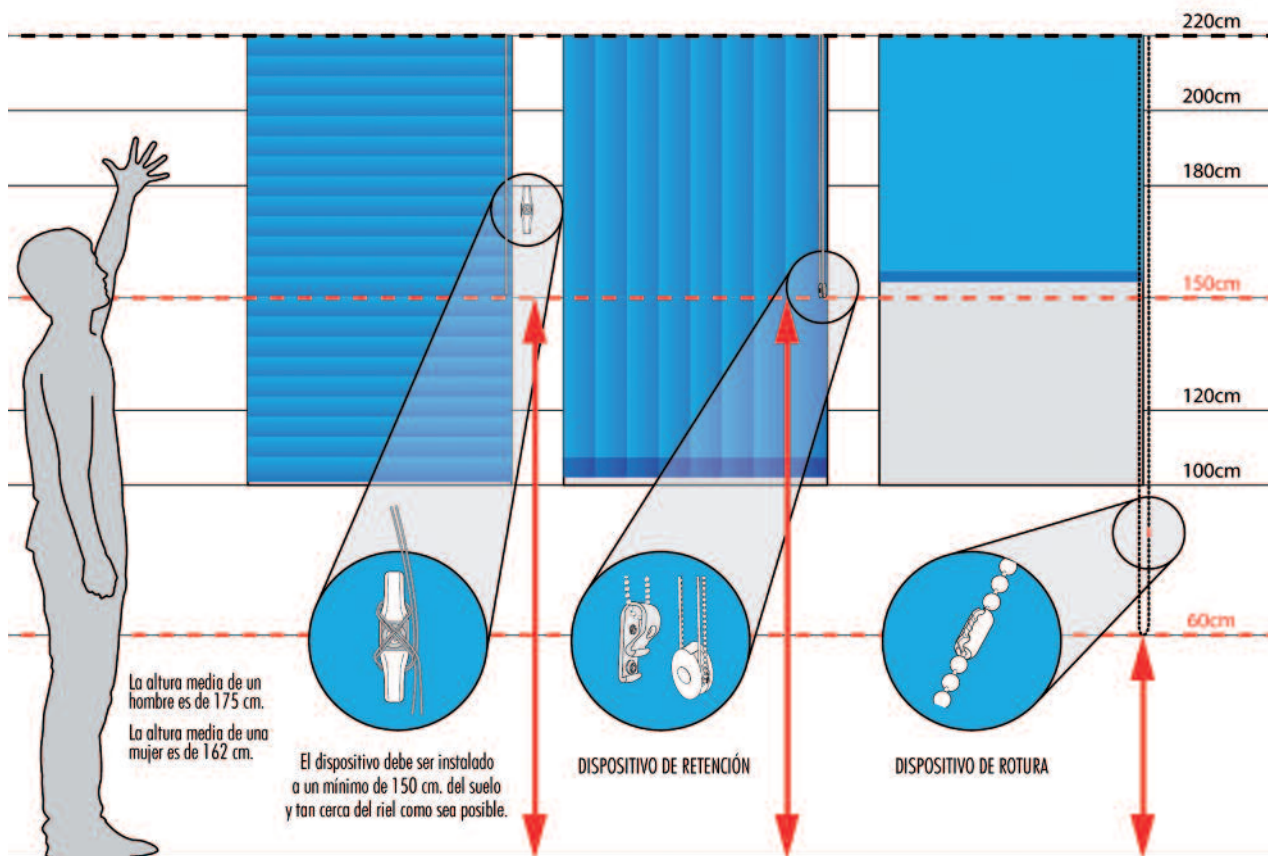



DISPOSITIVOS DE SEGURIDAD

DISPOSITIVO ROTURA CADENILLA
TRANSPARENTE

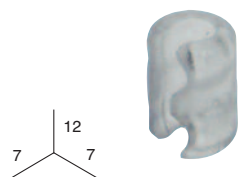

REF. **0282200**

x 200

20,35 €/Caja

DISPOSITIVO ROTURA
CADENILLA "H". BLANCO

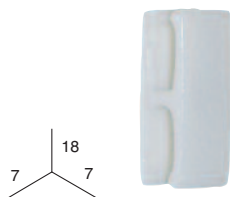

REF. **0297060**

x 50

17,14 €/Caja

DISPOSITIVO ROTURA
CADENILLA "8". BLANCO

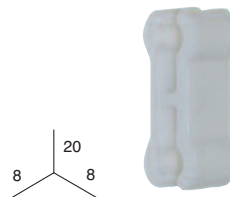

REF. **0710060**

x 50

17,14 €/Caja

DISPOSITIVO RETENCION FIJO
TRANSPARENTE

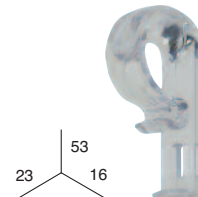

REF. **0286200**

x 25

0,83 €/u.

CORNAMUSA.
TRANSPARENTE

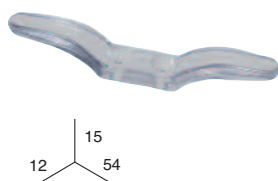

REF. **0714200**

x 25

0,43 €/u.

DISPOS.SEGURIDAD CADENILLA
AJUSTABLE. BLANCO

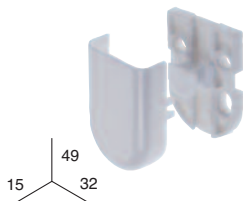

REF. **0711060**

x 10

0,53 €/u.

DISPOS.SEGURIDAD
CADENILLA. BLANCO

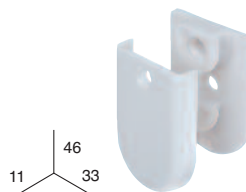

REF. **1482060**

x 10

0,83 €/u.

DISPOSITIVO SEGURIDAD
PARED. BLANCO

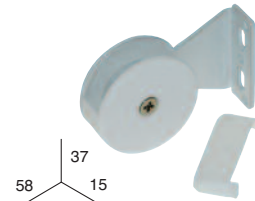

REF. **0712060**

x 10

1,13 €/u.

DISPOSITIVO SEGURIDAD
FRENTE. BLANCO

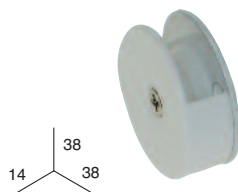

REF. **0713060**

x 10

1,43 €/u.

DISPOSITIVO ROTURA CINTA.
TRANSPARENTE

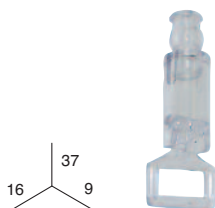

REF. **0283200**

x 50

20,35 €/Caja

ANILLA SEGURIDAD.
TRANSPARENTE

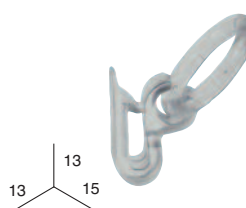

REF. **0709200**

x 100

6,44 €/Caja

UNIÓN HILOS SEGURIDAD.
BLANCO

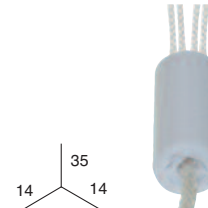

REF. **0715060**

x 25

6,44 €/Caja

TOPE DE SEGURIDAD. TRANSPA-
RENTE

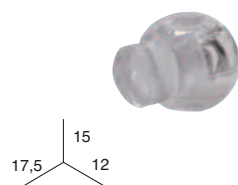

REF. **0334200**

x 50

18,38 €/Caja

TOPE DE SEGURIDAD PARA ENGAN-
CHAR. TRANSPARENTE

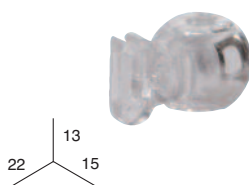

REF. **0341200**

x 50

22,05 €/Caja

TOPE DE SEGURIDAD PARA COSER.
TRANSPARENTE

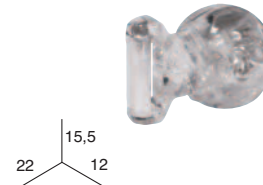

REF. **0339200**

x 50

22,05 €/Caja

** Colores: **06**= Blanco. **20**= Transparente.
Código de envasado: **0**= Granel.



СНУС



Aluminio





RIEL DE PERFIL 950 CON CORDÓN

CON TENSOR

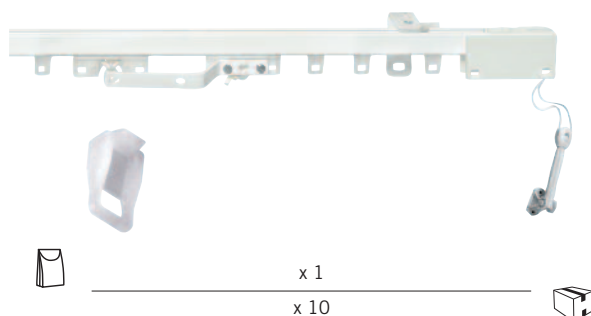

REF.	<---->	06	32
1958**4	1,00 m. (2 soportes)	12,80 €/u.	14,72 €/u.
0977**4	1,50 m. (3 soportes)	14,97 €/u.	17,21 €/u.
0978**4	2,00 m. (3 soportes)	16,90 €/u.	19,46 €/u.
0954**4	2,50 m. (4 soportes)	20,10 €/u.	23,12 €/u.
0964**4	3,00 m. (4 soportes)	22,13 €/u.	25,45 €/u.
0965**4	3,50 m. (4 soportes)	23,87 €/u.	27,46 €/u.
0981**4	4,00 m. (5 soportes)	24,80 €/u.	28,53 €/u.

CON CONTRAPESO

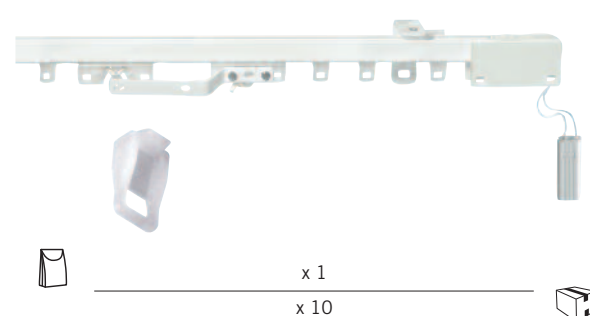

REF.	<---->	06
0838064	1,00 m. (2 soportes)	13,05 €/u.
0886064	1,50 m. (3 soportes)	15,31 €/u.
0887064	2,00 m. (3 soportes)	17,27 €/u.
0888064	2,50 m. (4 soportes)	20,51 €/u.
0889064	3,00 m. (4 soportes)	22,58 €/u.
0890064	3,50 m. (4 soportes)	24,37 €/u.
0869064	4,00 m. (5 soportes)	25,30 €/u.

RIEL DE PERFIL 950 SIN CORDÓN

CORREDERA PATÍN I072060

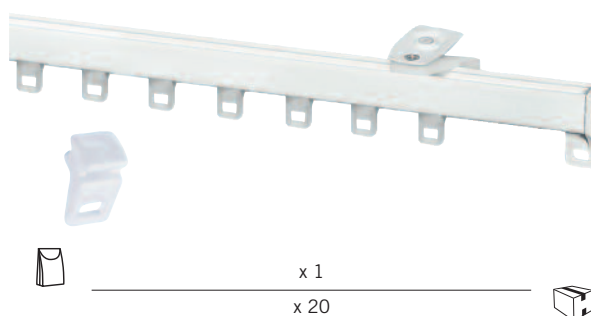

REF.	<---->	06	32
1959**4	1,00 m. (2 soportes)	7,94 €/u.	9,12 €/u.
0967**4	1,50 m. (3 soportes)	9,05 €/u.	10,42 €/u.
0968**4	2,00 m. (3 soportes)	10,93 €/u.	12,58 €/u.
0969**4	2,50 m. (4 soportes)	13,56 €/u.	15,59 €/u.
0970**4	3,00 m. (4 soportes)	15,56 €/u.	17,88 €/u.
0971**4	3,50 m. (4 soportes)	17,42 €/u.	20,02 €/u.
0997**4	4,00 m. (5 soportes)	18,81 €/u.	21,61 €/u.

CORREDERA CON RUEDA O689060

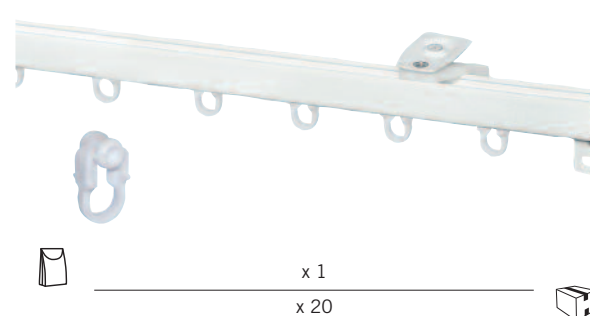

REF.	<---->	06
0739064	1,00 m. (2 soportes)	8,14 €/u.
0871064	1,50 m. (3 soportes)	9,31 €/u.
0872064	2,00 m. (3 soportes)	11,27 €/u.
0873064	2,50 m. (4 soportes)	13,98 €/u.
0874064	3,00 m. (4 soportes)	16,03 €/u.
0875064	3,50 m. (4 soportes)	17,95 €/u.
0797064	4,00 m. (5 soportes)	19,35 €/u.

RIEL DE PERFIL 950 SIN ACCESORIOS (BLISTER)

CORREDERA PATÍN I072060

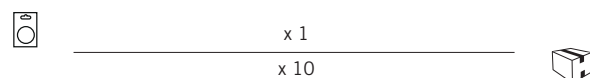

REF.	<---->	06	07
2511**2	1,50 m. (3 soportes)	10,36 €/u.	10,88 €/u.
2512**2	2,00 m. (3 soportes)	12,34 €/u.	12,96 €/u.
2513**2	2,50 m. (4 soportes)	14,75 €/u.	15,49 €/u.
2514**2	3,00 m. (4 soportes)	16,82 €/u.	17,66 €/u.

** Colores: 06= Blanco. 07= Negro. 32= Gris.
Código de envasado: 0= Granel. 4= Bolsa de protección.



PERFIL 950 Y ACCESORIOS

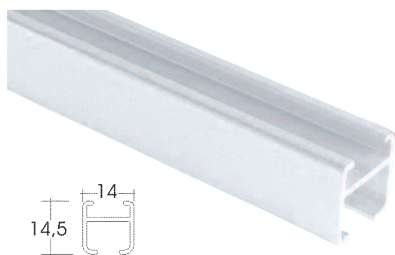

REF.	<---->	06	07	32
	x 40			
0950**0	6 m.	20,31 €/u.	21,32 €/u.	25,83 €/u.
1096**0	4 m.	13,58 €/u.	-	17,30 €/u.
1095**0	3 m.	10,22 €/u.	-	12,95 €/u.
1094**0	2 m.	6,80 €/u.	-	8,65 €/u.

CORREDERA FRENTE
(Ristra 10 Unidades)

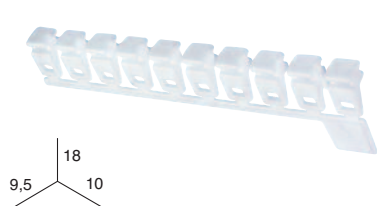

CORREDERA CON RUEDA
(Ristra 10 Unidades)

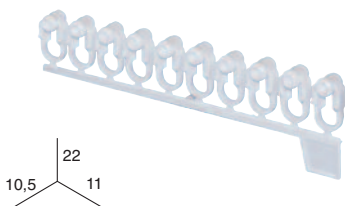

CORREDERA CON HILO "CHYC"



REF.	1072**0	1072**2	0689**0	0689**2	0232060	0270060
	x 400	x 20	x 400	x 20	Rollo x 100 m.	
06	14,71 €/Caja	1,47 €/bl.	20,74 €/Caja	2,69 €/bl.	1,64 €/m.	1,89 €/m.
07	15,46 €/Caja	1,54 €/bl.	21,14 €/Caja	2,69 €/bl.	-	-

CORREDERA CON HILO "CHYC"

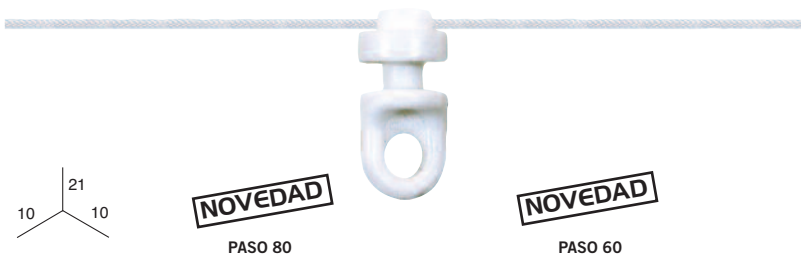

CORREDERA SIMPLE

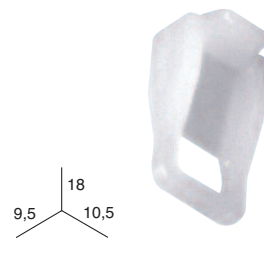

REF.	0348060	0349060	0346060	0347060	0906060
	2 m.	5 m.	2 m.	5 m.	x 500
06	3,33 €/u.	8,36 €/u.	3,83 €/u.	9,59 €/u.	9,52 €/Caja

CORREDERA SIMPLE CON RUEDA



CORREDERA MAESTRA

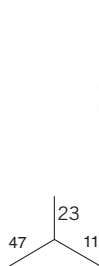

CORREDERA MAESTRA CON RUEDAS

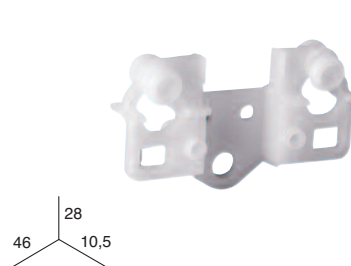

REF.	0907060	0907062	0962060	0953060
	x 500	x 20	x 50	x 50
06	29,72 €/Caja	2,27 €/bl.	0,21 €/u.	0,35 €/u.

Colores: 06= Blanco. 07= Negro.
Código de envasado: 0= Granel. 2= Blister.

ACCESORIOS PERFIL 950

PUENTE PARA CORREDERA MAESTRA
(recomendado para corredera con hilo)

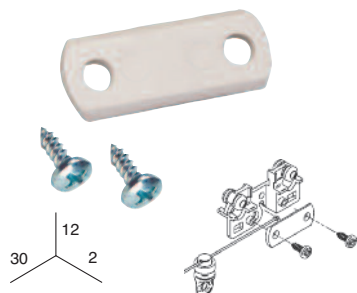

REF. **0652060**

x 50

06 **6,21 €/Caja**
40 -

CORREDERA MAESTRA CON PATA

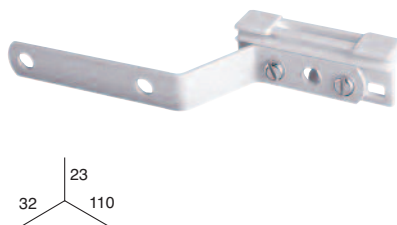

REF. **0913**0**

x 50

0,67 €/u.
0,56 €/u.

CORREDERA MAESTRA CON PATA CORTA
(recomendada para riel con curva)



REF. **0856060**

x 50

0,67 €/u.
-

CORREDERA MAESTRA CON RUEDA Y PATA

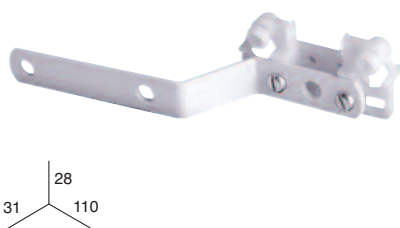

REF. **0952**0**

x 50

06 **0,69 €/u.**
07 **0,73 €/u.**
40 **0,64 €/u.**

CORREDERA MAESTRA CON RUEDA Y PATA CORTA (recomendada para riel con curva)

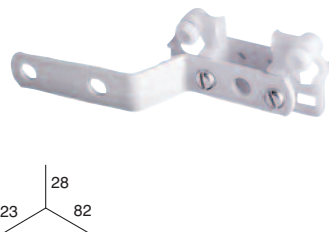

REF. **0851060**

x 50

0,70 €/u.
-
-

POLEA INTERMEDIA



REF. **1230400**

x 50

-
-
0,91 €/u.

MANGUITO PORTA-POLEAS

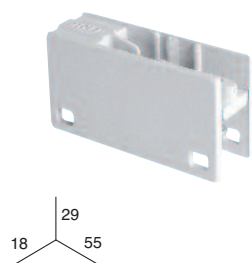

REF. **0957**0**

x 50

06 **0,95 €/u.**
07 -
32 **0,95 €/u.**

TOPE FINAL



REF. **0905**0**

x 50

6,16 €/Caja
6,48 €/Caja
6,16 €/Caja

UNIÓN ESQUINA

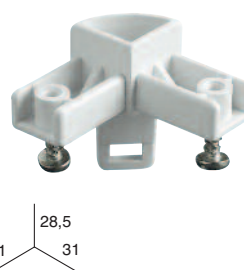

REF. **1073060**

x 25

0,26 €/u.
-
-

FIJADOR INTERMEDIO

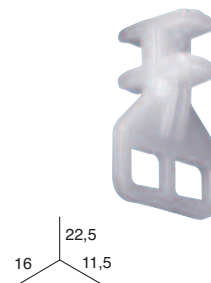

REF. **0892060**

x 50

3,55 €/Caja
-
-

** Colores: 06= Blanco. 07= Negro. 32= Gris. 40= Plata.
Código de envasado: 0= Granel.



ACCESORIOS PERFIL 950

CODO CON 2 EMPALMES
(radio interior=125 mm.)

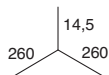
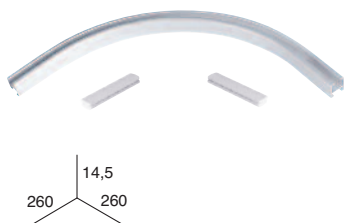

EMPALME
(perfil 950,910 y 900)

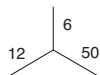

EMPALME
(perfil 950/910)



CORDÓN POLIÉSTER Ø2,5



REF.	0852**0	0956060	3950400	2556060
	x 10	x 50	x 10	Carrete x 200 m.
	06 5,17 €/u.	4,51 €/Caja	-	29,40 €/Carrete
	07 5,43 €/u.	-	-	
	40 5,25 €/u.	-	1,85 €/u.	

CONTRAPESO CON GANCHO



CONTRAPESO 30 gr.



CONTRAPESO 70 ó 110 gr.

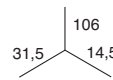

REF.	0400060	0400062	0421060	0421062	1204**0	1224060
	x 25	x 2	x 50	x 2	x 10	x 10
	06 0,54 €/u.	2,70 €/bl.	0,61 €/u.	2,91 €/bl.	1,24 €/u.	1,45 €/u.
	32 -	-	-	-	1,87 €/u.	-

TENSOR

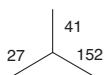

SOPORTE TECHO CON ESTRIBO

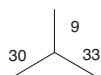

ESTRIBO TECHO (con tornillo y taco)

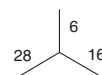

REF.	0419060	0419062	0993**0	0993**2	0904**0
	x 25	x 1	x 50	x 2	x 50
	06 0,94 €/u.	4,34 €/bl.	0,29 €/u.	1,80 €/bl.	0,17 €/u.
	07 -	-	0,35 €/u.	1,89 €/bl.	0,19 €/u.
	40 -	-	0,25 €/u.	1,71 €/bl.	-

Colores: 06= Blanco. 07= Negro. 32= Gris. 40= Plata.
Código de envasado: 0= Granel. 2= Blister.

ACCESORIOS PERFIL 950

SOPORTE 3 cm.

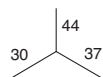
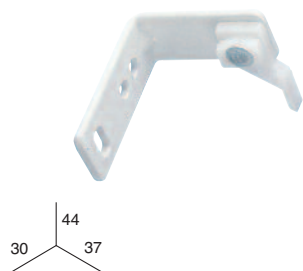

SOPORTE 6 cm.

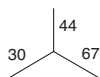
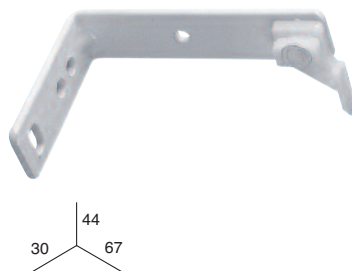

SOPORTE DOBLE 3-9 cm.

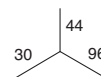
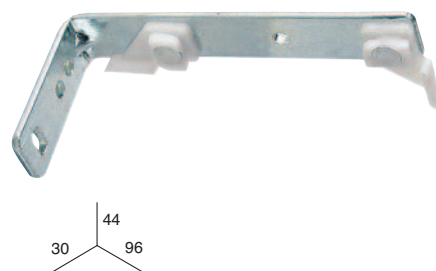

REF.	0901**0	0902**0	0903**0
	x 50	x 50	x 50
06	0,39 €/u.	0,50 €/u.	0,68 €/u.
40	0,39 €/u.	0,50 €/u.	0,68 €/u.

SOPORTE REFORZADO 3 cm.

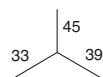
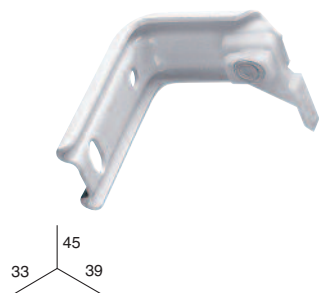

SOPORTE REFORZADO 6 cm.

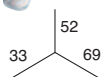
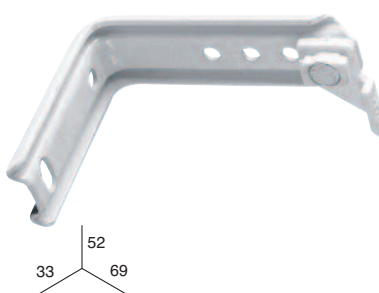

SOPORTE DOBLE REFORZADO 3-9 cm.

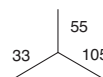

REF.	0818**0	0818**2	0819**0	0819**2	0960**0	0960**2
	x 50	x 2	x 50	x 2	x 50	x 2
06	0,52 €/u.	2,61 €/bl.	0,63 €/u.	2,92 €/bl.	0,77 €/u.	4,05 €/bl.
07	0,62 €/u.	2,61 €/bl.	0,73 €/u.	2,92 €/bl.	0,83 €/u.	4,05 €/bl.
40	0,52 €/u.	2,61 €/bl.	0,63 €/u.	2,92 €/bl.	0,77 €/u.	4,05 €/bl.

PLETINA DOBLE TECHO 70

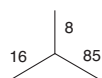

PLETINA DOBLE TECHO 100

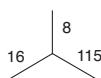
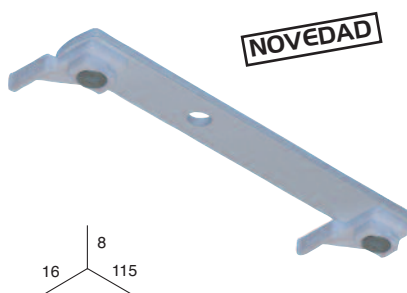

REF.	0064060	0105060
	x 50	x 50
06	1,94 €/u.	2,19 €/u.

** Colores: 06= Blanco. 07= Negro. 40= Plata.
Código de envasado: 0= Granel. 2= Blister.



RIEL DE PERFIL 910 CON CORDÓN

CON TENSOR

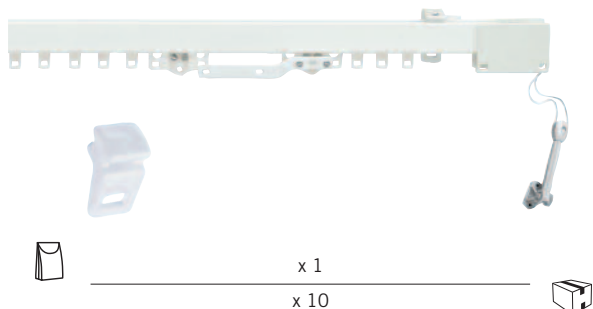

CON CONTRAPESO

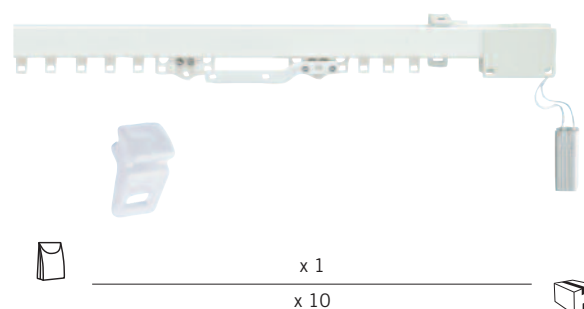

REF.	<---->	06	32
1960**4	1,00 m. (2 soportes)	15,95 €/u.	18,34 €/u.
0972**4	1,50 m. (3 soportes)	19,35 €/u.	22,27 €/u.
0973**4	2,00 m. (3 soportes)	22,11 €/u.	25,45 €/u.
0974**4	2,50 m. (4 soportes)	26,40 €/u.	30,37 €/u.
0975**4	3,00 m. (4 soportes)	29,24 €/u.	33,64 €/u.
0976**4	3,50 m. (4 soportes)	32,03 €/u.	36,86 €/u.
0979**4	4,00 m. (5 soportes)	34,31 €/u.	39,46 €/u.

REF.	<---->	06
0877064	1,00 m. (2 soportes)	16,29 €/u.
0880064	1,50 m. (3 soportes)	19,76 €/u.
0881064	2,00 m. (3 soportes)	22,55 €/u.
0882064	2,50 m. (4 soportes)	26,94 €/u.
0883064	3,00 m. (4 soportes)	29,81 €/u.
0884064	3,50 m. (4 soportes)	32,71 €/u.
0895064	4,00 m. (5 soportes)	34,98 €/u.

RIEL DE PERFIL 910 SIN CORDÓN

SOPORTE FRENTE TECHO Y CORREDERA PATÍN I072060

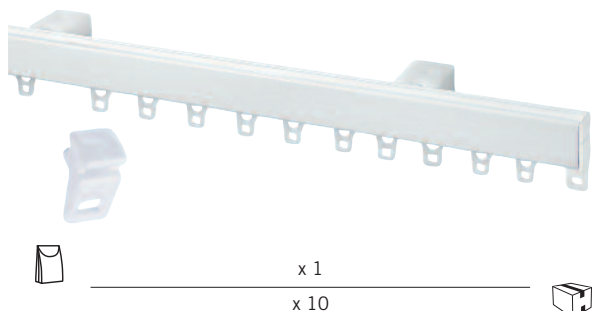

SOPORTE TECHO Y CORREDERA CON RUEDA O689060

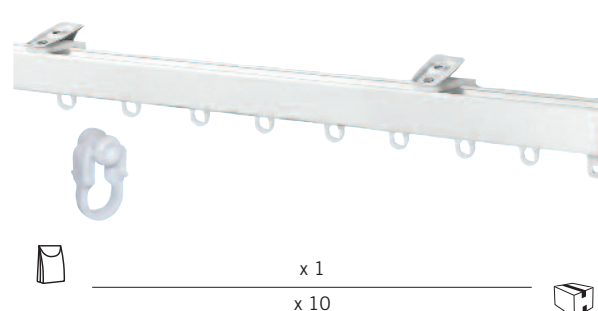

REF.	<---->	06	32
2225**4	1,00 m. (2 soportes)	8,00 €/u.	9,21 €/u.
1926**4	1,50 m. (3 soportes)	11,10 €/u.	12,78 €/u.
1927**4	2,00 m. (3 soportes)	13,78 €/u.	15,84 €/u.
1928**4	2,50 m. (4 soportes)	17,10 €/u.	19,67 €/u.
1929**4	3,00 m. (4 soportes)	19,90 €/u.	22,87 €/u.
1930**4	3,50 m. (4 soportes)	22,48 €/u.	25,85 €/u.
2226**4	4,00 m. (5 soportes)	25,37 €/u.	29,16 €/u.

REF.	<---->	06
0737064	1,00 m. (2 soportes)	9,07 €/u.
0858064	1,50 m. (3 soportes)	11,27 €/u.
0859064	2,00 m. (3 soportes)	13,73 €/u.
0860064	2,50 m. (4 soportes)	17,09 €/u.
0861064	3,00 m. (4 soportes)	19,57 €/u.
0862064	3,50 m. (4 soportes)	21,99 €/u.
0738064	4,00 m. (5 soportes)	24,84 €/u.

PERFIL 910

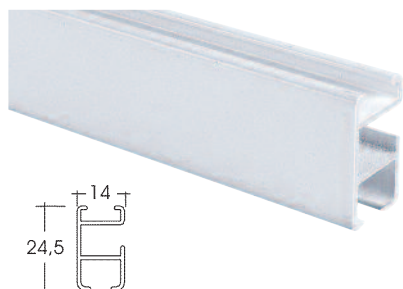

REF.	<---->	06	07	32
0910**0	6 m.	30,63 €/u.	32,17 €/u.	34,71 €/u.
1093**0	4 m.	20,52 €/u.	-	23,23 €/u.
1092**0	3 m.	15,34 €/u.	-	17,41 €/u.
1091**0	2 m.	10,28 €/u.	-	11,64 €/u.

Colores: 06= Blanco. 07= Negro. 32= Gris.
Código de envasado: 0= Granel. 4= Bolsa de protección.



ACCESORIOS PERFIL 910

CORREDERA FRENTE
(Ristra 10 Unidades)

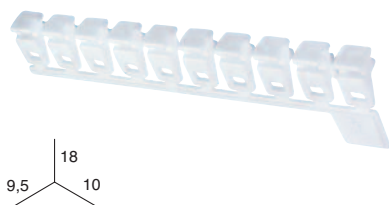

CORREDERA CON RUEDA
(Ristra 10 Unidades)

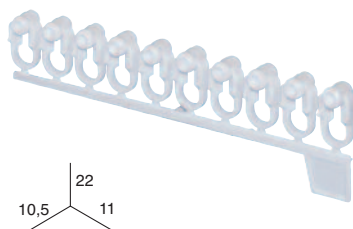

CORREDERA CON HILO "CHYC"

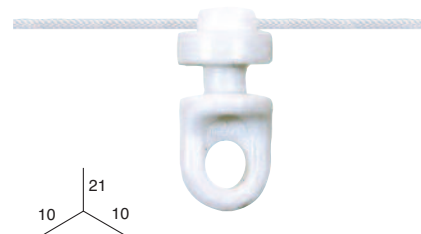

REF.	1072**0	1072**2	0689**0	0689**2	PASO 80 0232060	PASO 60 0270060
	x 400	x 20	x 400	x 20	Rollo x 100 m.	
06	14,71 €/Caja	1,47 €/bl.	20,74 €/Caja	2,69 €/bl.	1,64 €/m.	1,89 €/m.
07	15,46 €/Caja	1,54 €/bl.	21,14 €/Caja	2,69 €/bl.	-	-

CORREDERA CON HILO "CHYC"



CORREDERA SIMPLE



CORREDERA SIMPLE CON RUEDA

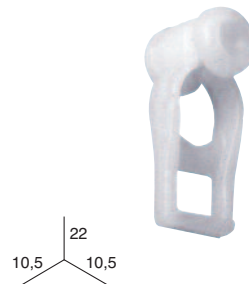

REF.	0348060	0349060	0346060	0347060	0906060	0907060	0907062
	2 m.	5 m.	2 m.	5 m.	x 500	x 500	x 20
06	3,33 €/u.	8,36 €/u.	3,83 €/u.	9,59 €/u.	9,52 €/Caja	29,72 €/Caja	2,27 €/bl.

CORREDERA MAESTRA SIN RUEDA

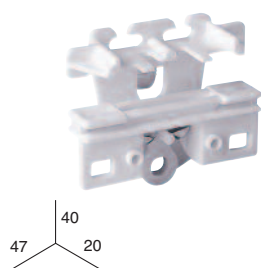

CORREDERA MAESTRA CON RUEDA

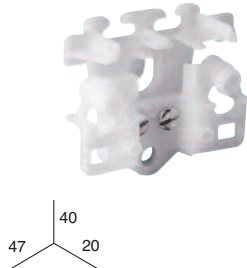

CORREDERA MAESTRA SIN RUEDA Y CON PATA

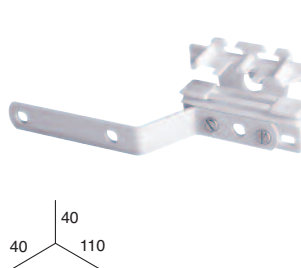

CORREDERA MAESTRA CON RUEDA Y CON PATA

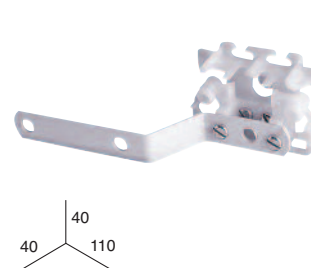

REF.	0912060	0951060	0914**0	0911**0
	x 50	x 50	x 50	x 50
06	0,49 €/u.	0,61 €/u.	0,86 €/u.	0,89 €/u.
40	-	-	0,82 €/u.	0,83 €/u.

** Colores: 06= Blanco. 07= Negro. 40= Plata.
Código de envasado: 0= Granel. 2= Blister.



ACCESORIOS PERFIL 910

PUENTE PARA CORREDERA MAESTRA
(recomendado para corredera con hilo)

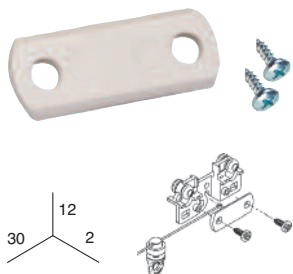

REF. **0652060**

x 50

06 **6,21 €/Caja**
32 -

CORDÓN POLIÉSTER Ø2,5



REF. **2556060**

Carrete x 200 m.

29,40 €/Carrete

UNIÓN MANGUITOS
PORTA-POLEAS P-900 Y 910
(para porta-poleas 7297060 y 7298060)

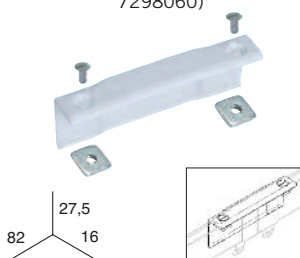

REF. **7430060**

x 10

2,13 €/u.

MANGUITO PORTA-POLEAS



REF. **0958**0**

x 50

1,00 €/u.
1,00 €/u.

PORTA-POLEAS

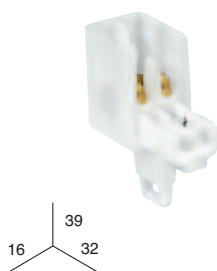

REF. **7298060**

x 50

06 **0,82 €/u.**

PORTA-POLEAS RETORNO

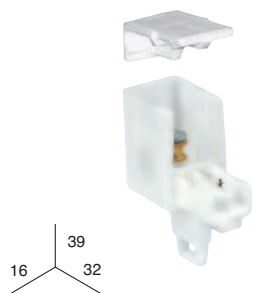

REF. **7397060**

x 50

0,74 €/u.

POLEA INTERMEDIA

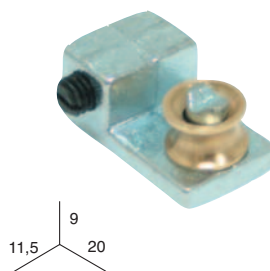

REF. **7297400**

x 50

0,63 €/u.

FIJADOR INTERMEDIO



REF. **0892060**

x 50

3,55 €/Caja

TOPE FINAL



REF. **0905**0**

x 50

06 **6,16 €/Caja**
07 **6,48 €/Caja**
32 **6,16 €/Caja**

EMPALME
(perfil 950,910 y 900)

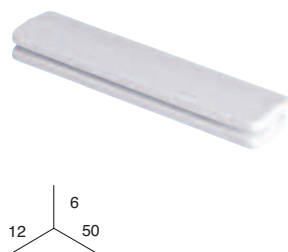

REF. **0956060**

x 50

4,51 €/Caja

EMPALME
(perfil 950/910)

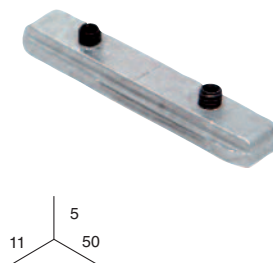

REF. **3950400**

x 10

-
-
1,85 €/u.

UNIÓN ESQUINA

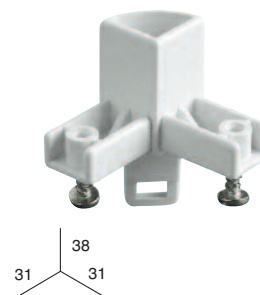

REF. **1062060**

x 25

0,26 €/u.
-
-

** Colores: 06= Blanco. 07= Negro. 32= Gris. 40= Plata.
Código de envasado: 0= Granel.

ACCESORIOS PERFIL 910

TENSOR

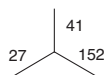
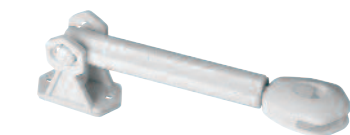

CONTRAPESO 30 gr.



CONTRAPESO 50 gr.
CON GANCHO



REF.	0419060	0419062	0421060	0421062	0400060	0400062
	x 25	x 1	x 50	x 2	x 25	x 2
06	0,94 €/u.	4,34 €/bl.	0,61 €/u.	2,91 €/bl.	0,54 €/u.	2,70 €/bl.

CONTRAPESO 70 ó 110 gr.

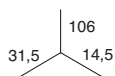

70 gr. 110 gr.

SOPORTE FRENTE

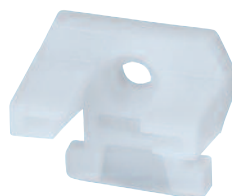

SOPORTE FRENTE-TECHO

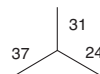

SOPORTE FRENTE-TECHO



REF.	1204*0	1224060	1557060	7499060	1509060
	x 10	x 10	x 50	x 50	x 50
06	1,24 €/u.	1,45 €/u.	7,64 €/Caja	0,30 €/u.	0,30 €/u.
32	1,87 €/u.	-	-	-	-

SOPORTE LATERAL

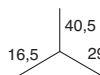

SOPORTE LATERAL



SOPORTE TECHO CON ESTRIBO

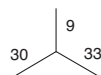

ESTRIBO TECHO
(con tornillo y taco)



REF.	0955**0	7216**0	0993**0	0993**2	0904**0
	x 50	x 50	x 50	x 2	x 50
06	0,35 €/u.	0,54 €/u.	0,29 €/u.	1,80 €/bl.	0,17 €/u.
07	-	-	0,35 €/u.	1,89 €/bl.	0,19 €/u.
32	0,36 €/u.	-	-	-	-
40	-	0,53 €/u.	0,25 €/u.	1,71 €/bl.	-

** Colores: 06= Blanco. 07= Negro. 32= Gris. 40= Plata.
Código de envasado: 0= Granel. 2= Blister.



ACCESORIOS PERFIL 910

SOPORTE 3 cm.

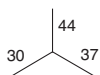

SOPORTE 6 cm.

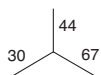

SOPORTE DOBLE 3-9 cm.

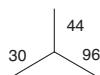

REF.	0901**0	0902**0	0903**0
	x 50	x 50	x 50
06	0,39 €/u.	0,50 €/u.	0,68 €/u.
40	0,39 €/u.	0,50 €/u.	0,68 €/u.

SOPORTE REFORZADO 3 cm.

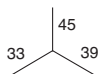

SOPORTE REFORZADO 6 cm.

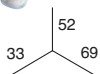

SOPORTE DOBLE REFORZADO 3-9 cm.

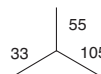

REF.	0818**0	0818**2	0819**0	0819**2	0960**0	0960**2
	x 50	x 2	x 50	x 2	x 50	x 2
06	0,52 €/u.	2,61 €/bl.	0,63 €/u.	2,92 €/bl.	0,77 €/u.	4,05 €/bl.
07	0,62 €/u.	2,61 €/bl.	0,73 €/u.	2,92 €/bl.	0,83 €/u.	4,05 €/bl.
40	0,52 €/u.	2,61 €/bl.	0,63 €/u.	2,92 €/bl.	0,77 €/u.	4,05 €/bl.

PLETINA DOBLE TECHO 70



NOVEDAD

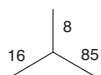

PLETINA DOBLE TECHO 100

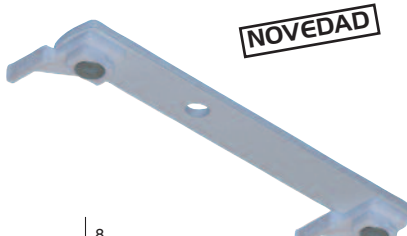

NOVEDAD

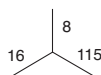

REF.	0064060	0105060
	x 50	x 50
06	1,94 €/u.	2,19 €/u.

** Colores: 06= Blanco. 07= Negro. 40= Plata.
Código de envasado: 0= Granel. 2= Blister.

NOVEDAD



RIEL DE PERFIL 650 SIN CORDÓN

SOPORTE TECHO Y CORREDERA CON RUEDA 0689060

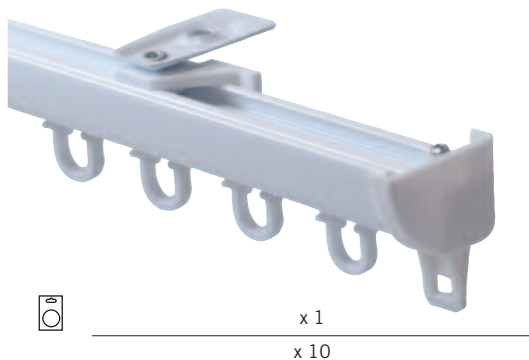

REF.	<---->	06	07
0677**2	1,50 m. (3 soportes)	11,98 €/u.	12,58 €/u.
0678**2	2,00 m. (3 soportes)	12,96 €/u.	13,61 €/u.
0679**2	2,50 m. (4 soportes)	17,87 €/u.	18,76 €/u.

ACCESORIOS COMPATIBLES

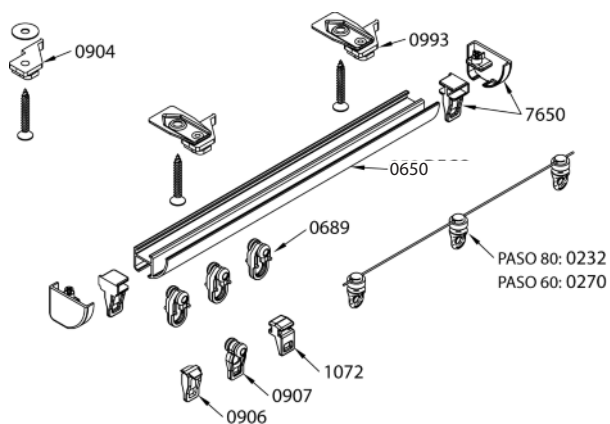

PERFIL 650 Y ACCESORIOS

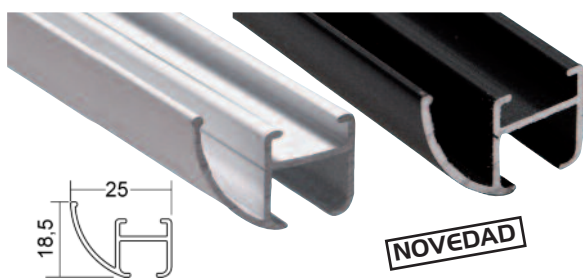

REF.	<---->	06	07
0650**0	6 m.	24,58 €/u.	25,80 €/u.
0644**0	4 m.	16,39 €/u.	17,21 €/u.

GANCHO FINAL Y TAPÓN PAR PERFIL

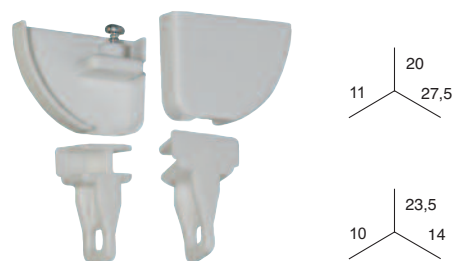

REF.	7650**0
	x 10 juegos
06	1,56 €/u.
07	1,56 €/u.

SOPORTE REFORZADO 3 cm.

SOPORTE REFORZADO 6 cm.

SOPORTE DOBLE REFORZADO 3-9 cm.

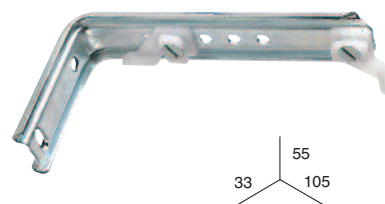
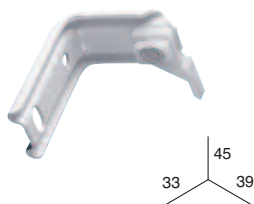

REF.	0818**0	0818**2	0819**0	0819**2	0960**0	0960**2
	x 50	x 2	x 50	x 2	x 50	x 2
06	0,52 €/u.	2,61 €/bl.	0,63 €/u.	2,92 €/bl.	0,77 €/u.	4,05 €/bl.
07	0,62 €/u.	2,61 €/bl.	0,73 €/u.	2,92 €/bl.	0,83 €/u.	4,05 €/bl.
40	0,52 €/u.	2,61 €/bl.	0,63 €/u.	2,92 €/bl.	0,77 €/u.	4,05 €/bl.

** Colores: 06= Blanco. 07= Negro.
Código de envasado: 0= Granel. 2= Blister.

NOVEDAD



PERFIL 660 Y ACCESORIOS

PERFIL 660



NOVEDAD

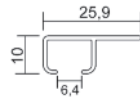

CORREDERA FRENTE
(Ristra 10 Unidades)



CORREDERA CON RUEDA
(Ristra 10 Unidades)

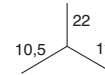
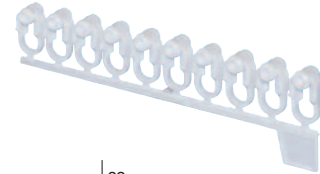

REF.	←-----→	06	07	32
0660**0	6 m.	22,05 €/u.	23,15 €/u.	26,46 €/u.
0658**0	4 m.	14,70 €/u.	15,44 €/u.	17,64 €/u.

REF.	1072**0	1072**2	0689**0	0689**2
	x 400	x 20	x 400	x 20
06	14,71 €/Caja	1,47 €/bl.	20,74 €/Caja	2,69 €/bl.
07	15,46 €/Caja	1,54 €/bl.	21,14 €/Caja	2,69 €/bl.

CORREDERA SIMPLE

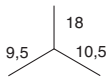

CORREDERA SIMPLE
CON RUEDA

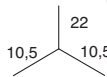

CORREDERA MAESTRA

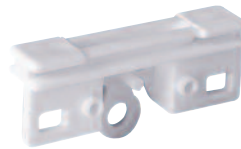

CORREDERA MAESTRA
CON RUEDAS

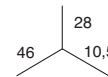
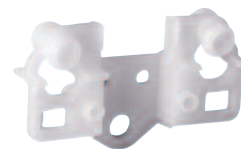

REF.	0906060	0907060	0907062	0962060	0953060
	x 500	x 500	x 20	x 50	x 50
06	9,52 €/Caja	29,72 €/Caja	2,27 €/bl.	0,21 €/u.	0,35 €/u.

CORREDERA MAESTRA
CON PATA

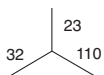

CORREDERA MAESTRA
CON RUEDA Y PATA

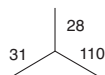

TOPE FINAL



FIJADOR INTERMEDIO

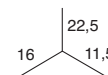

REF.	0913**0	0952**0	7301**0	0892060
	x 50	x 50	x 50	x 50
06	0,67 €/u.	0,69 €/u.	6,70 €/Caja	3,55 €/Caja
07	-	0,73 €/u.	7,04 €/Caja	-
40	0,56 €/u.	0,64 €/u.	-	-

** Colores: 06= Blanco. 07= Negro. 32= Gris. 40= Plata.
Código de envasado: 0= Granel. 2= Blister.



PERFIL 900 Y ACCESORIOS

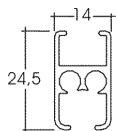

REF.	<---->		06	32
0900**0	6 m.	x 40	34,66 €/u.	38,45 €/u.
1084**0	4 m.	x 40	23,20 €/u.	25,73 €/u.
1083**0	3 m.	x 40	17,41 €/u.	19,37 €/u.
1082**0	2 m.	x 40	11,63 €/u.	12,89 €/u.



PERFIL RECOMENDADO PARA DOBLE CURVA CON CORDÓN

CORREDERA CON HILO "CHYC"

CORREDERA SIMPLE

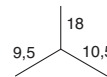
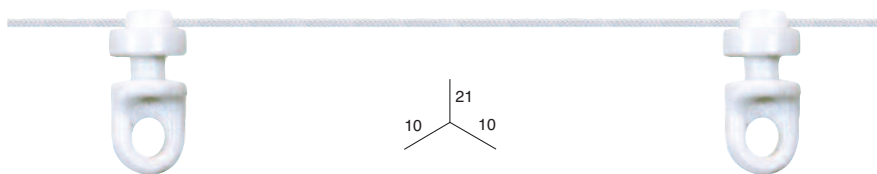

NOVEDAD

NOVEDAD

	PASO 80	PASO 60	PASO 80		PASO 60		
REF.	0232060	0270060	0348060	0349060	0346060	0347060	0906060
	Rollo x 100 m.		2 m.	5 m.	2 m.	5 m.	x 500
06	1,64 €/m.	1,89 €/m.	3,33 €/u.	8,36 €/u.	3,83 €/u.	9,59 €/u.	9,52 €/Caja

CORREDERA SIMPLE CON RUEDA

CORREDERA CON RUEDA (Ristra 10 Unidades)

CORREDERA MAESTRA CON RUEDA Y PATA

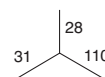
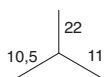
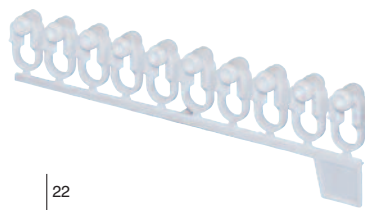
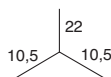
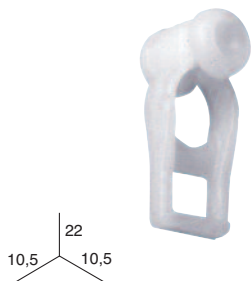

REF.	0907060	0907062	0689**0	0689**2	0952**0
	x 500	x 20	x 400	x 20	x 50
06	29,72 €/Caja	2,27 €/bl.	20,74 €/Caja	2,69 €/bl.	0,69 €/u.
07	-	-	21,14 €/Caja	2,69 €/bl.	0,73 €/u.
40	-	-	-	-	0,64 €/u.

** Colores: 06= Blanco. 07= Negro. 32= Gris. 40= Plata.
Código de envasado: 0= Granel. 2= Blister.



PERFIL 900 Y ACCESORIOS

CORREDERA MAESTRA CON RUEDA Y PATA CORTA (recomendada para riel con curva)

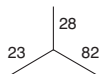

PUENTE PARA CORREDERA MAESTRA (recomendado para corredera con hilo)

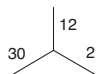
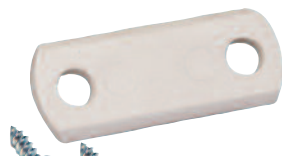

CORREDERA MAESTRA CON RUEDAS

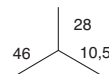

REF.	0851060	0652060	0953060
	x 50	x 50	x 50
06	0,70 €/u.	6,21 €/Caja	0,35 €/u.

CORREDERA MAESTRA (Especial para riel curvo)



(radio mínimo 125)

BRIDA CORDÓN

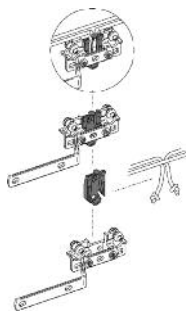

Solo para utilizar correderas con hilo

CORDÓN POLIÉSTER Ø2,5



REF.	0185060	7801060	2556060
	x 25	x 25	Carrete x 200 m.
06	0,42 €/u.	3,51 €/Caja	29,40 €/Carrete

UNIÓN MANGUITOS PORTA-POLEAS P-900 Y 910 (para porta-poleas 7297060 y 7298060)

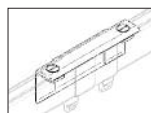
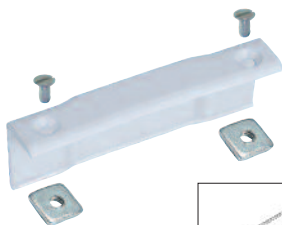

PORTA-POLEAS

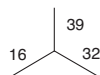

PORTA-POLEAS RETORNO



REF.	7430060	7298060	7397060
	x 10	x 50	x 50
06	2,13 €/u.	0,82 €/u.	0,74 €/u.

** Colores: 06= Blanco.
Código de envasado: 0= Granel.

ACCESORIOS PERFIL 900

MANGUITO PORTA-POLEAS

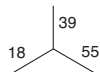

EMPALME

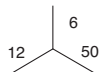

EMPALME

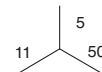
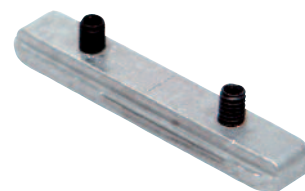

REF. **0958**0**

x 50

REF. **0956060**

x 50

REF. **3900400**

x 10

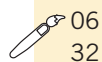

06
32

1,00 €/u.
1,00 €/u.

4,51 €/Caja

-
2,01 €/u.

CONTRAPESO CON GANCHO

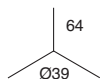

CONTRAPESO 30 gr.



CONTRAPESO 70 ó 110 gr.

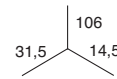

70 gr.

110 gr.

REF. **0400060**

x 25

REF. **0400062**

x 2

REF. **0421060**

x 50

REF. **0421062**

x 2

REF. **1204**0**

x 10

REF. **1224060**

x 10

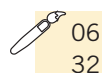

06
32

0,54 €/u.

2,70 €/bl.

0,61 €/u.

2,91 €/bl.

1,24 €/u.

1,45 €/u.

-

-

-

-

1,87 €/u.

-

TENSOR

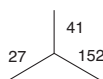

SOPORTE TECHO

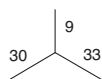

ESTRIBO TECHO (Con tornillo y taco)

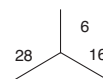

REF. **0419060**

x 25

REF. **0419062**

x 1

REF. **0993**0**

x 50

REF. **0993**2**

x 2

REF. **0904**0**

x 50

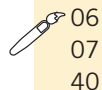

06
07
40

0,94 €/u.

4,34 €/bl.

0,29 €/u.

1,80 €/bl.

0,17 €/u.

-

-

0,35 €/u.

1,89 €/bl.

0,19 €/u.

-

-

0,25 €/u.

1,71 €/bl.

-

** Colores: 06= Blanco. 07= Negro. 32= Gris. 40= Plata.
Código de envasado: 0= Granel. 2= Blister.



ACCESORIOS PERFIL 900

SOPORTE 3 cm.

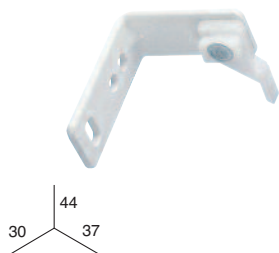

SOPORTE 6 cm.

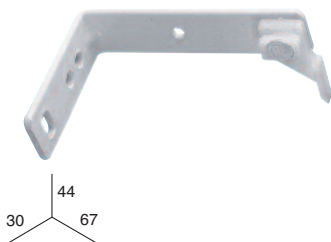

SOPORTE DOBLE 3-9 cm.



REF.	0901**0	0902**0	0903**0
	x 50	x 50	x 50
06	0,39 €/u.	0,50 €/u.	0,68 €/u.
40	0,39 €/u.	0,50 €/u.	0,68 €/u.

SOPORTE REFORZADO 3 cm.



SOPORTE REFORZADO 6 cm.

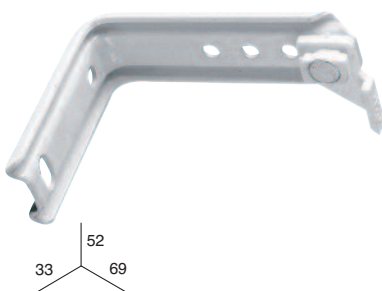

SOPORTE DOBLE REFORZADO 3-9 cm.



REF.	0818**0	0818**2	0819**0	0819**2	0960**0	0960**2
	x 50	x 2	x 50	x 2	x 50	x 2
06	0,52 €/u.	2,61 €/bl.	0,63 €/u.	2,92 €/bl.	0,77 €/u.	4,05 €/bl.
07	0,62 €/u.	2,61 €/bl.	0,73 €/u.	2,92 €/bl.	0,83 €/u.	4,05 €/bl.
40	0,52 €/u.	2,61 €/bl.	0,63 €/u.	2,92 €/bl.	0,77 €/u.	4,05 €/bl.

PLETINA DOBLE TECHO 70



PLETINA DOBLE TECHO 100

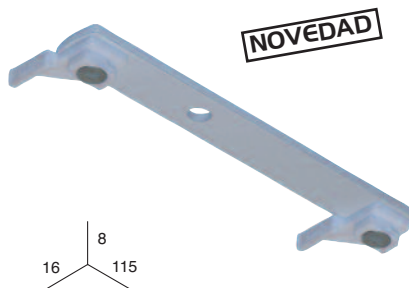

REF.	0064060	0105060
	x 50	x 50
06	1,94 €/u.	2,19 €/u.

** Colores: 06= Blanco. 07= Negro. 40= Plata.
Código de envasado: 0= Granel. 2= Blister.



RIEL DE PERFIL 7247 (para curvar a mano)

SOPORTE FRENTE-TECHO 7281060



x 1
x 10



REF.	<---->	06	REF.	<---->	06
7219062	1,50 m. (3 soportes)	13,15 €/u.	7222062	3,00 m. (6 soportes)	21,95 €/u.
7220062	2,00 m. (4 soportes)	15,89 €/u.	7394062	3,50 m. (8 soportes)	26,69 €/u.
7221062	2,50 m. (5 soportes)	19,89 €/u.	7395062	4,00 m. (8 soportes)	28,51 €/u.

SOPORTE GRAPA TECHO 7285060



x 1
x 10



REF.	<---->	06	REF.	<---->	06
7249062	1,50 m. (3 soportes)	13,13 €/u.	7252062	3,00 m. (6 soportes)	21,97 €/u.
7250062	2,00 m. (4 soportes)	15,88 €/u.	7438062	3,50 m. (8 soportes)	24,12 €/u.
7251062	2,50 m. (5 soportes)	19,89 €/u.	7431062	4,00 m. (8 soportes)	27,21 €/u.

PERFIL 7247 Y ACCESORIOS (para curvar a mano)

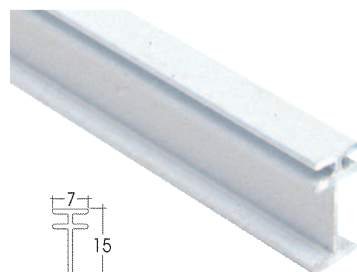

CORREDERA PERFIL I



GRAPA TECHO "CHYC"

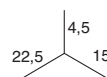

REF.	<---->	06	REF.	7283430	7283432	7285060
7247060	4 m.	10,04 €/u.				
7246060	3 m.	7,53 €/u.				
7245060	2 m.	5,05 €/u.				
			43	0,12 €/u.	4,75 €/bl.	06 0,14 €/u.

** Colores: 06= Blanco. 43= Cromado.
Código de envasado: 0= Granel. 2= Blister.



PERFIL 7247 Y ACCESORIOS (para curvar a mano)

ESTRIBO FRENTE
(Para refs. 7187060 y 7188060)

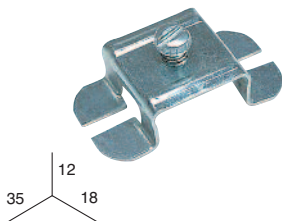

SOPORTE TECHO
ARTICULADO

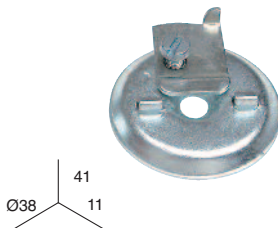

SOPORTE FRENTE-TECHO

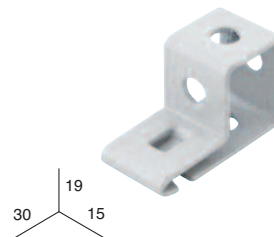

REF.	7286400	7284400	7281060
------	----------------	----------------	----------------

x 100

x 100

x 100

06
40

0,55 €/u.

0,76 €/u.

0,50 €/u.

TOPE FINAL

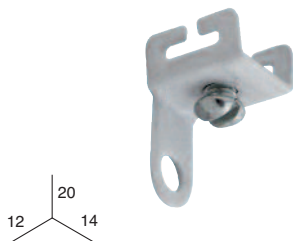

EMPALME

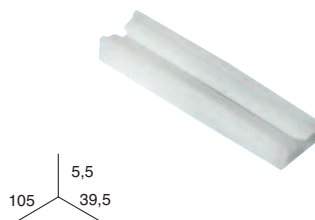

SOPORTE FRENTE 6 cm.
(Para ref. 7286400)

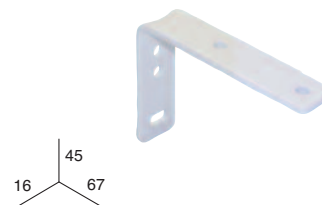

REF.	7278060	7800060	0771060
------	----------------	----------------	----------------

x 100

x 50

x 50

06

0,25 €/u.

5,69 €/Caja

0,52 €/u.

SOPORTE FRENTE 9 cm.
(Para ref. 7286400)

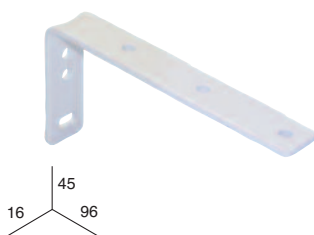

SOPORTE FRENTE 12 cm.
(Para ref. 7286400)

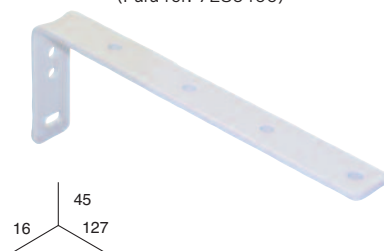

GANCHO-ANILLA (para guía volante)

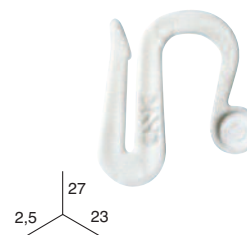

REF.	7187060	7188060	1893060
------	----------------	----------------	----------------

x 50

x 50

x 500

06

0,66 €/u

0,72 €/u

18,61 €/Caja

MONTAJE DEL PERFIL 7247 EN GALERÍA (curvado a mano)

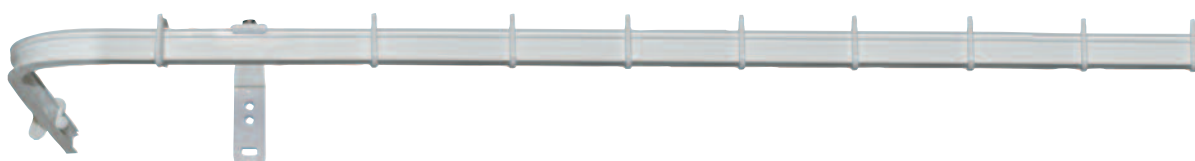

Colores: **06**= Blanco. **40**= Plata.
Código de envasado: **0**= Granel.



PERFIL 908 Y ACCESORIOS (para división de espacios)

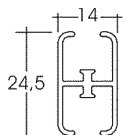
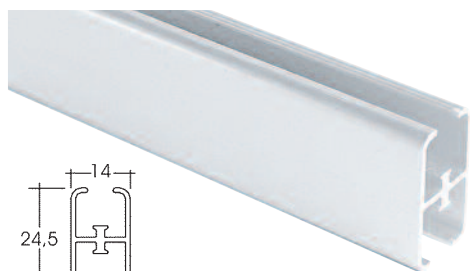

CORREDERA FRENTE
(Ristra 10 Unidades)

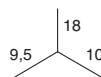
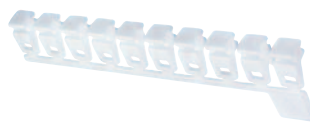

CORREDERA CON RUEDA
(Ristra 10 Unidades)
(no válida para perfil curvo)

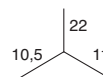
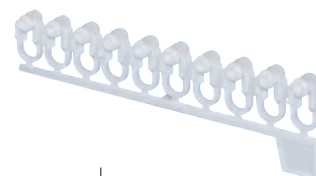

REF.	←-----→	x 40	06
0908060	6 m.	x 40	38,68 €/u.
1087060	4 m.	x 40	25,85 €/u.
1086060	3 m.	x 40	19,38 €/u.
1085060	2 m.	x 40	12,95 €/u.

REF.	1072**0	1072**2	0689**0	0689**2
	x 400	x 20	x 400	x 20
06	14,71 €/Caja	1,47 €/bl.	20,74 €/Caja	2,69 €/bl.
07	15,46 €/Caja	1,54 €/bl.	21,14 €/Caja	2,69 €/bl.

CORREDERA SIMPLE
(no válida para perfil curvo)

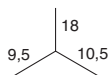

CORREDERA SIMPLE CON RUEDA

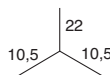

CORREDERA ESPECIAL BAÑO



REF.	0906060	0907060	0907062	1201060
	x 500	x 500	x 20	x 500
06	9,52 €/Caja	29,72 €/Caja	2,27 €/bl.	17,63 €/Caja

CODO (Radio interior: 93 mm.)

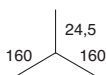

TAPAJUNTAS

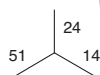

JUNQUILLO DE PLÁSTICO (10 m.)

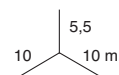

REF.	7310060	7309060	7306060
	x 12	x 25	x 10
06	6,05 €/u.	0,30 €/u.	17,25 €/10 m.

Colores: **06**= Blanco. **07**= Negro.
Código de envasado: **0**= Granel. **2**= Blister.



PERFIL 908 Y ACCESORIOS (para división de espacios)

EMPALME DE ALUMINIO

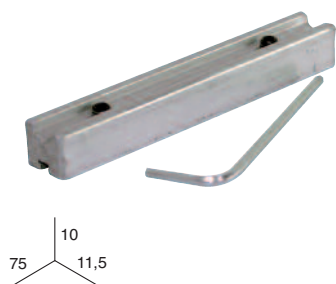

UNIÓN DE PERFILES

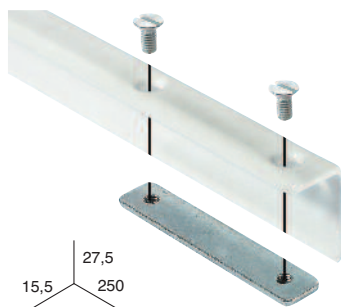

PLETINA UNIÓN CRUZ

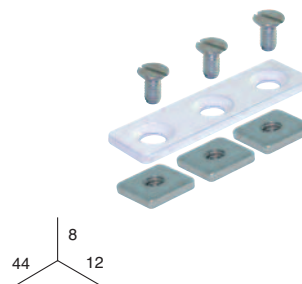

REF.	7320400	7305060	7307060
------	---------	---------	---------

x 12

x 10

x 25

06
40

-
3,08 €/u.

2,82 €/u.
-

1,06 €/u.
-

ESTRIBO TECHO

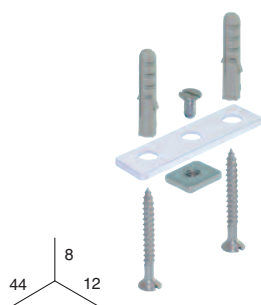

FIJADOR INTERMEDIO



TOPE PORTATELA FIJO

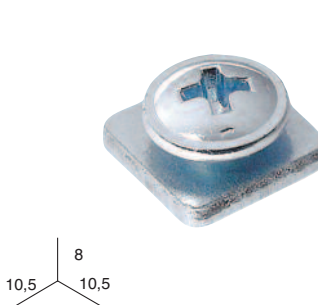

REF.	7308060	0892060	0917400
------	---------	---------	---------

x 25

x 50

x 100

06

0,69 €/u.

3,55 €/Caja

0,35 €/u.

TOPE FINAL



SOPORTE LATERAL

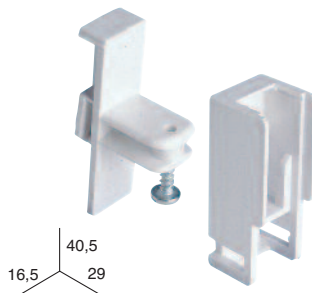

SOPORTE TECHO "CHYC" (0,70 m.)

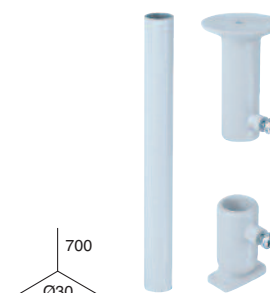

REF.	0905**0	0955**0	0963**0
------	---------	---------	---------

x 50

x 50

x 25

06 6,16 €/Caja.

0,35 €/u.

3,38 €/u.

07

6,48 €/Caja.

-

-

32 6,16 €/Caja.

0,36 €/u.

-

40

-

3,14 €/u.

** Colores: 06= Blanco. 07= Negro. 32= Gris. 40= Plata.
Código de envasado: 0= Granel.

PERFIL 908 Y ACCESORIOS (para división de espacios)

SOPORTE TECHO "CHYC" (1,00 m.)

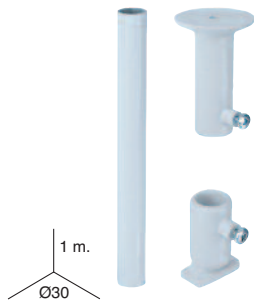

ACCESORIO PARA SOPORTE TECHO "CHYC"

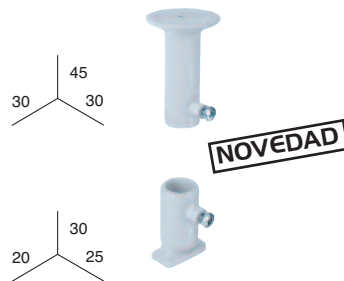

CASQUILLO RIOSTRA

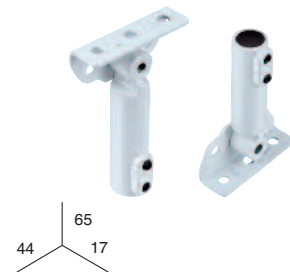

REF.	0654060	0665060	0744060
	x 25	x 10 juegos	x 6 juegos
06	3,66 €/u.	0,90 €/Juego	6,29 €/Juego

TUBO PARA CASQUILLO RIOSTRA

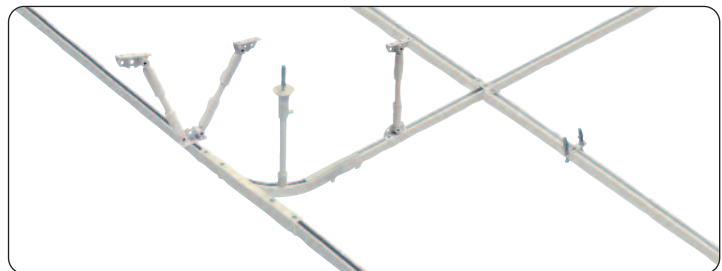

(3,00 m.)	A medida
0437060	0437064
x 10	
8,76 €/u.	3,50 €/m.



MONTAJE CASQUILLO RIOSTRA + TUBO

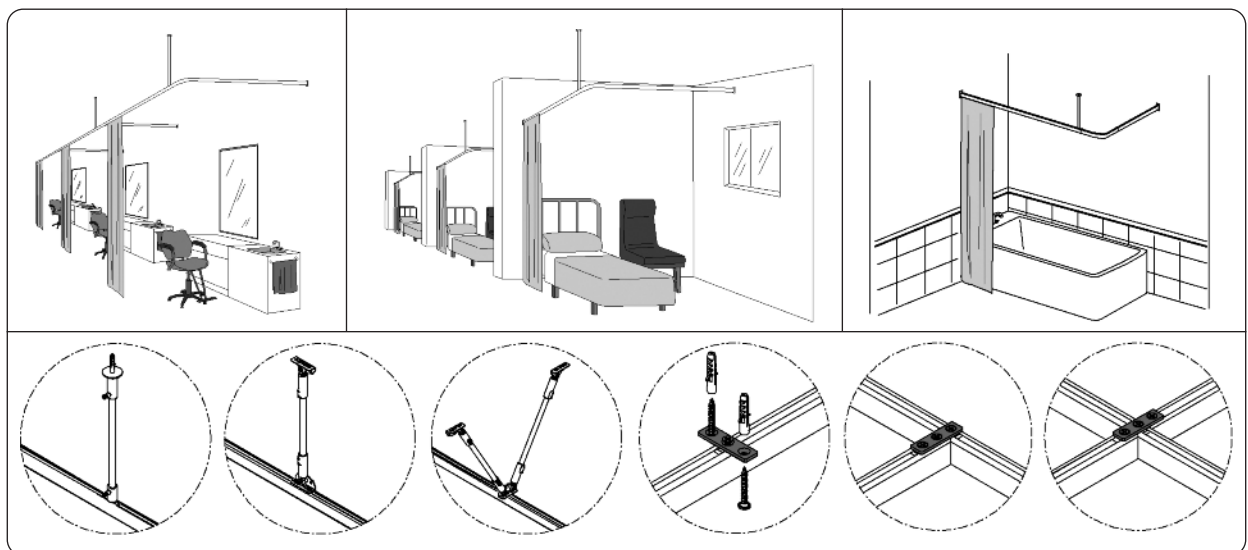

NOTA: Soliciten presupuesto a nuestro departamento comercial.

Colores: 06= Blanco.
Código de envasado: 0= Granel. 4= Bolsa de protección.



RIEL A MEDIDA ONDAS. PERFIL 7600



<---->	06. BLANCO	MODALIDAD A	MODALIDAD B	32. GRIS	MODALIDAD A	MODALIDAD B
		(Distanciador de 9 cm.) A1/ A2/ A3/ A4	(Distanciador de 6 cm.) B1/ B2/ B3/ B4		(Distanciador de 9 cm.) A1/ A2/ A3/ A4	(Distanciador de 6 cm.) B1/ B2/ B3/ B4
Hasta 0,90 m. (2 sop.)	9030090	20,36 €	21,00 €	9031090	22,50 €	23,15 €
De 0,91-1,20 m. (2 sop.)	9030120	26,25 €	26,89 €	9031120	28,73 €	29,58 €
De 1,21-1,50 m. (2 sop.)	9030150	32,13 €	32,78 €	9031150	34,91 €	35,98 €
De 1,51-1,80 m. (2 sop.)	9030180	38,04 €	38,67 €	9031180	41,15 €	42,41 €
De 1,81-2,10 m. (3 sop.)	9030210	43,93 €	44,56 €	9031210	47,33 €	48,84 €
De 2,11-2,40 m. (3 sop.)	9030240	49,81 €	50,45 €	9031240	53,55 €	55,27 €
De 2,41-2,70 m. (3 sop.)	9030270	55,69 €	56,35 €	9031270	59,79 €	61,70 €
De 2,71-3,00 m. (3 sop.)	9030300	61,59 €	62,24 €	9031300	65,98 €	68,12 €
De 3,01-3,30 m. (4 sop.)	9030330	67,47 €	68,13 €	9031330	72,19 €	74,56 €
De 3,31-3,60 m. (4 sop.)	9030360	73,38 €	74,03 €	9031360	78,40 €	80,99 €
De 3,61-3,90 m. (4 sop.)	9030390	79,28 €	79,92 €	9031390	84,63 €	87,41 €
De 3,91-4,20 m. (4 sop.)	9030420	85,16 €	85,81 €	9031420	90,84 €	93,84 €
De 4,21-4,50 m. (4 sop.)	9030450	91,04 €	91,68 €	9031450	97,04 €	100,24 €

RIEL A MEDIDA ONDAS DECORATIVO. PERFIL 7600

SOPORTE A TECHO (rf. 0252**0)



<---->	06. BLANCO	MODALIDAD A	MODALIDAD B	49. ACERO INOX	MODALIDAD A	MODALIDAD B
		(Distanciador de 9 cm.) A1/ A2/ A3/ A4	(Distanciador de 6 cm.) B1/ B2/ B3/ B4		(Distanciador de 9 cm.) A1/ A2/ A3/ A4	(Distanciador de 6 cm.) B1/ B2/ B3/ B4
Hasta 0,90 m. (2 sop.)	9087090	27,27 €	29,46 €	9058090	32,72 €	33,38 €
De 0,91-1,20 m. (2 sop.)	9087120	33,32 €	35,86 €	9058120	39,98 €	40,78 €
De 1,21-1,50 m. (2 sop.)	9087150	39,40 €	42,23 €	9058150	47,28 €	48,23 €
De 1,51-1,80 m. (2 sop.)	9087180	45,45 €	48,65 €	9058180	54,54 €	55,63 €
De 1,81-2,10 m. (3 sop.)	9087210	51,52 €	55,03 €	9058210	61,82 €	63,06 €
De 2,11-2,40 m. (3 sop.)	9087240	57,58 €	61,42 €	9058240	69,10 €	70,48 €
De 2,41-2,70 m. (3 sop.)	9087270	63,64 €	67,81 €	9058270	76,37 €	77,90 €
De 2,71-3,00 m. (3 sop.)	9087300	69,70 €	74,22 €	9058300	83,64 €	85,31 €
De 3,01-3,30 m. (4 sop.)	9087330	75,76 €	80,61 €	9058330	90,91 €	92,73 €
De 3,31-3,60 m. (4 sop.)	9087360	81,84 €	87,01 €	9058360	98,21 €	100,17 €
De 3,61-3,90 m. (4 sop.)	9087390	87,89 €	93,41 €	9058390	105,47 €	107,58 €
De 3,91-4,20 m. (4 sop.)	9087420	93,97 €	99,81 €	9058420	112,76 €	115,02 €
De 4,21-4,50 m. (4 sop.)	9087450	100,03 €	106,22 €	9058450	120,04 €	122,44 €

SOPORTE FRENTE DECORATIVO (rf. 7607**4)

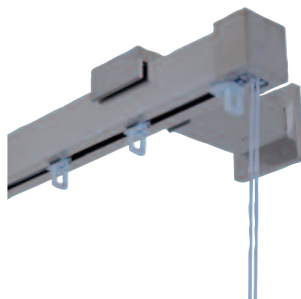

<---->	06. BLANCO	MODALIDAD A	MODALIDAD B	49. ACERO INOX	MODALIDAD A	MODALIDAD B
		(Distanciador de 9 cm.) A1/ A2/ A3/ A4	(Distanciador de 6 cm.) B1/ B2/ B3/ B4		(Distanciador de 9 cm.) A1/ A2/ A3/ A4	(Distanciador de 6 cm.) B1/ B2/ B3/ B4
Hasta 0,90 m. (2 sop.)	9062090	48,26 €	50,44 €	9050090	53,72 €	54,38 €
De 0,91-1,20 m. (2 sop.)	9062120	55,16 €	57,67 €	9050120	62,00 €	62,80 €
De 1,21-1,50 m. (2 sop.)	9062150	62,06 €	64,90 €	9050150	70,28 €	71,22 €
De 1,51-1,80 m. (2 sop.)	9062180	68,96 €	72,13 €	9050180	78,56 €	79,64 €
De 1,81-2,10 m. (3 sop.)	9062210	75,86 €	79,36 €	9050210	86,84 €	88,06 €
De 2,11-2,40 m. (3 sop.)	9062240	82,76 €	86,59 €	9050240	95,12 €	96,48 €
De 2,41-2,70 m. (3 sop.)	9062270	89,66 €	93,82 €	9050270	103,40 €	104,90 €
De 2,71-3,00 m. (3 sop.)	9062300	96,56 €	101,05 €	9050300	111,68 €	113,32 €
De 3,01-3,30 m. (4 sop.)	9062330	103,46 €	108,28 €	9050330	119,96 €	121,74 €
De 3,31-3,60 m. (4 sop.)	9062360	110,36 €	115,51 €	9050360	128,24 €	130,16 €
De 3,61-3,90 m. (4 sop.)	9062390	117,26 €	122,74 €	9050390	136,52 €	138,58 €
De 3,91-4,20 m. (4 sop.)	9062420	124,16 €	129,97 €	9050420	144,80 €	147,00 €
De 4,21-4,50 m. (4 sop.)	9062450	131,06 €	137,20 €	9050450	153,08 €	155,42 €

COMPONENTES RIEL ONDAS Y RIEL ONDAS DECORATIVO

MODALIDAD A con distanciador de 9 cm. (rf. 0246**0) / MODALIDAD B con distanciador de 6 cm. (rf. 0247**0)

MODALIDAD A1/B1/A3/B3 (apertura lateral o central con cordón): Distanciador correspondiente, perfil 7600, corredera (rf. 0241**0), corredera maestra (rf. 0242**0), unión hilos (rf. 0245**0), soporte techo (rf. 0252**0), portapoleas (rf.0250**0) y cordón (rf. 2551**0).

MODALIDAD A2/B2/A4/B4 (apertura lateral o central sin cordón): Distanciador correspondiente, perfil 7600, corredera (rf. 0241**0), soporte techo (rf. 0252**0) y tapón (rf.7605**0).



RIEL A MEDIDA ONDAS PERFIL 7600 SIN CORDÓN Y CON DISTANCIADOR



←----→	06. BLANCO	MODALIDAD A	MODALIDAD B	32. GRIS	MODALIDAD A	MODALIDAD B
		(Distanciador de 9 cm.)	(Distanciador de 6 cm.)		(Distanciador de 9 cm.)	(Distanciador de 6 cm.)
		A1/ A2/ A3/ A4	B1/ B2/ B3/ B4		A1/ A2/ A3/ A4	B1/ B2/ B3/ B4
Hasta 0,90 m. (2 sop.)	9052090	19,85 €	20,46 €	9018090	21,83 €	22,51 €
De 0,91-1,20 m. (2 sop.)	9052120	23,81 €	24,38 €	9018120	26,20 €	26,82 €
De 1,21-1,50 m. (2 sop.)	9052150	29,77 €	30,37 €	9018150	32,74 €	33,40 €
De 1,51-1,80 m. (2 sop.)	9052180	35,72 €	36,31 €	9018180	39,29 €	39,94 €
De 1,81-2,10 m. (3 sop.)	9052210	41,67 €	42,27 €	9018210	45,84 €	46,50 €
De 2,11-2,40 m. (3 sop.)	9052240	47,63 €	48,24 €	9018240	52,39 €	53,06 €
De 2,41-2,70 m. (3 sop.)	9052270	53,58 €	54,22 €	9018270	58,94 €	59,64 €
De 2,71-3,00 m. (3 sop.)	9052300	59,54 €	60,17 €	9018300	65,49 €	66,18 €
De 3,01-3,30 m. (4 sop.)	9052330	65,49 €	66,13 €	9018330	72,04 €	72,74 €
De 3,31-3,60 m. (4 sop.)	9052360	71,44 €	72,06 €	9018360	78,59 €	79,27 €
De 3,61-3,90 m. (4 sop.)	9052390	77,40 €	78,03 €	9018390	85,14 €	85,83 €
De 3,91-4,20 m. (4 sop.)	9052420	83,35 €	83,99 €	9031420	91,68 €	92,39 €
De 4,21-4,50 m. (4 sop.)	9052450	89,30 €	89,93 €	9031450	98,23 €	98,93 €

NOTA: Para rieles en color acero inoxidable se añadira un 10% al color blanco.

TABLA DE LONGITUDES

Montaje de riel con la cinta Cortitex 75/2.



CON CORDÓN. RECOGIDA SIMÉTRICA

Nº de Ondas	Nº de Enganches	Nº de Correreras	Distanciador 9 cm.	Distanciador 6 cm.
2	8	3	0,59	0,41
3	12	5	0,95	0,65
4	16	7	1,31	0,89
5	20	9	1,67	1,13
6	24	11	2,03	1,37
7	28	13	2,39	1,61
8	32	15	2,75	1,85
9	36	17	3,11	2,09
10	40	19	3,47	2,33
11	44	21	3,83	2,57
12	48	23	-	2,81
13	52	25	-	3,05
14	56	27	-	3,29

SIN CORDÓN. RECOGIDA SIMÉTRICA

Nº de Ondas	Nº de Enganches	Nº de Correreras	Distanciador 9 cm.	Distanciador 6 cm.
2	8	3	0,56	0,38
3	12	5	0,92	0,62
4	16	7	1,28	0,86
5	20	9	1,64	1,10
6	24	11	2,00	1,34
7	28	13	2,36	1,58
8	32	15	2,72	1,82
9	36	17	3,08	2,06
10	40	19	3,44	2,30
11	44	21	3,80	2,54
12	48	23	-	2,78
13	52	25	-	3,02
14	56	27	-	3,26

CON CORDÓN. RECOGIDA A UN LADO

Nº de Ondas	Nº de Enganches	Nº de Correreras	Distanciador 9 cm.	Distanciador 6 cm.
3	6	5	0,50	0,35
4	8	7	0,68	0,47
5	10	9	0,86	0,59
6	12	11	1,04	0,71
7	14	13	1,22	0,83
8	16	15	1,40	0,95
9	18	17	1,58	1,07
10	20	19	1,76	1,19
11	22	21	1,94	1,31
12	24	23	2,12	1,43
13	26	25	2,30	1,55
14	28	27	2,48	1,67
15	30	29	2,66	1,79
16	32	31	2,84	1,91
17	34	33	3,02	2,03
18	36	35	3,20	2,15
19	38	37	3,38	2,27
20	40	39	3,56	2,39
21	42	41	3,74	2,51
22	44	43	3,92	2,63
23	46	45	-	2,75
24	48	47	-	2,87
25	50	49	-	2,99
26	52	51	-	3,11
27	54	53	-	3,23
28	56	55	-	3,33

SIN CORDÓN. RECOGIDA A UN LADO

Nº de Ondas	Nº de Enganches	Nº de Correreras	Distanciador 9 cm.	Distanciador 6 cm.
3	6	5	0,47	0,32
4	8	7	0,65	0,44
5	10	9	0,83	0,56
6	12	11	1,01	0,68
7	14	13	1,19	0,80
8	16	15	1,37	0,92
9	18	17	1,55	1,04
10	20	19	1,73	1,16
11	22	21	1,91	1,28
12	24	23	2,09	1,40
13	26	25	2,27	1,52
14	28	27	2,45	1,64
15	30	29	2,63	1,76
16	32	31	2,81	1,88
17	34	33	2,99	2,00
18	36	35	3,17	2,12
19	38	37	3,35	2,24
20	40	39	3,53	2,36
21	42	41	3,71	2,48
22	44	43	3,89	2,60
23	46	45	-	2,72
24	48	47	-	2,84
25	50	49	-	2,96
26	52	51	-	3,08

NOTA: Para los cálculos del riel ONDAS DECO, hay que añadir 1 cm. a cada una de las medidas que figuran en esta tabla, sea con cordón o sin cordón.

Colores: 06= Blanco. 32= Gris.



RIEL SIN CORDÓN. PERFIL 7600

CORREDERA REF. 0689060 Y SOPORTE TECHO 0252**0

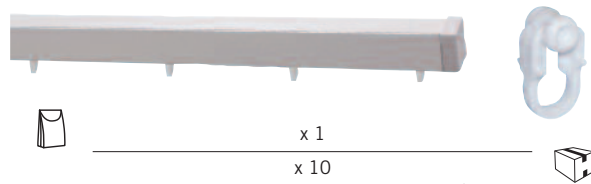

CORREDERA REF. 8075060 Y SOPORTE TECHO 0252**0

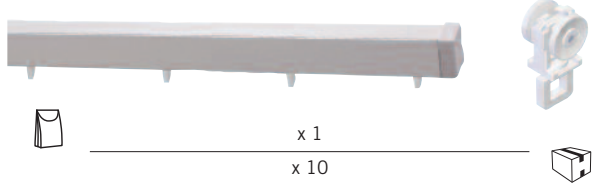

REF.	<---->	06	32	49
7479**4	1,50 m. (3 sop.)	13,67 €/u.	17,00 €/u.	21,62 €/u.
7480**4	2,00 m. (3 sop.)	16,89 €/u.	21,28 €/u.	26,00 €/u.
7481**4	2,50 m. (4 sop.)	21,02 €/u.	26,48 €/u.	31,29 €/u.
7482**4	3,00 m. (4 sop.)	24,30 €/u.	30,94 €/u.	35,85 €/u.
7483**4	3,50 m. (4 sop.)	27,54 €/u.	35,27 €/u.	40,23 €/u.
7484**4	4,00 m. (5 sop.)	31,42 €/u.	40,24 €/u.	45,33 €/u.

REF.	<---->	06	32	49
7485**4	1,50 m. (3 sop.)	40,95 €/u.	44,18 €/u.	39,71 €/u.
7486**4	2,00 m. (3 sop.)	52,64 €/u.	56,98 €/u.	52,77 €/u.
7487**4	2,50 m. (4 sop.)	64,30 €/u.	69,79 €/u.	65,83 €/u.
7488**4	3,00 m. (4 sop.)	75,96 €/u.	82,57 €/u.	78,88 €/u.
7489**4	3,50 m. (4 sop.)	87,69 €/u.	95,38 €/u.	91,95 €/u.
7490**4	4,00 m. (5 sop.)	99,34 €/u.	108,14 €/u.	104,97 €/u.

PERFIL 7600 Y ACCESORIOS

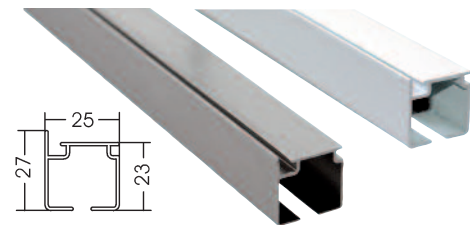

REF.	<---->	06	32	49
7600**0	6 m.	39,76 €/u.	53,01 €/u.	61,05 €/u.
7603**0	4 m.	26,53 €/u.	35,33 €/u.	40,70 €/u.
7606**0	3 m.	20,94 €/u.	-	30,60 €/u.

CORREDERA SIMPLE
(Siempre junto al distanciador)

CORREDERA MAESTRA
UNION DE HILOS (Interior)

PATA RIEL ONDAS

CORREDERA MAESTRA
UNION DE HILOS (Exterior)

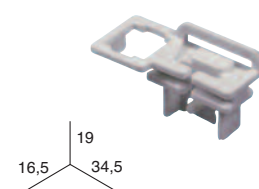
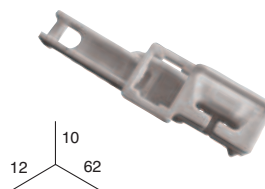
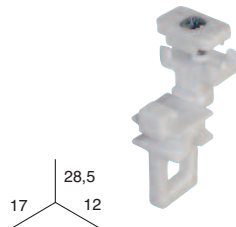
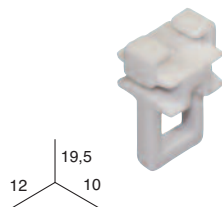

REF.	0241**0	0242060	0311**0	0245**0
	x 200	x 50	x 50	x 50
06	7,84 €/Caja	0,20 €/u.	0,13 €/u.	0,12 €/u.
32	7,84 €/Caja	-	0,13 €/u.	0,12 €/u.

DISTANCIADOR 9 cm.

DISTANCIADOR 6 cm.

2 PORTAPOLEAS Y 1 BRIDA (juego)

SOPORTE TECHO

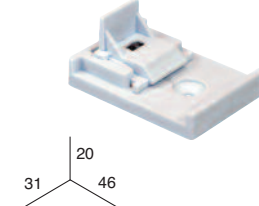
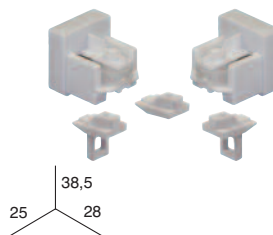
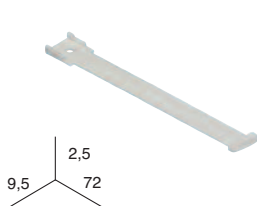
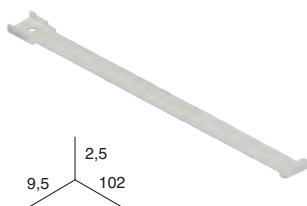

REF.	0246**0	0247**0	0250**0	0252**0
	x 250	x 250	x 25 juegos	x 25
06	9,26 €/Caja	8,59 €/Caja	0,96 €/Juego	0,91 €/u.
32	9,26 €/Caja	8,59 €/Caja	0,96 €/Juego	0,91 €/u.

** Colores: 06= Blanco. 32= Gris. 49= Acero inoxidable.
Código de envasado: 0= Granel. 4= Bolsa de protección.



ACCESORIOS

EMPALME

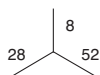

CORDÓN TRENZADO Ø2



CINTA CORTITEX 75/2. TRANSPARENTE

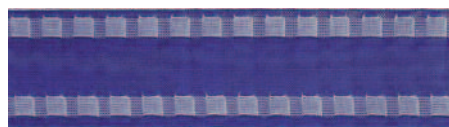

Ganchos cada nº de bolsa	A	RAPPORT	
		Distanciador 6 cm.	Distanciador 9 cm.
6	A= 9,5 cm.	1,5/1	-
8	A= 13 cm.	2/1	-
8	A= 13 cm.	-	1,5/1
10	A= 15,5 cm.	-	2/1

REF.	7604**0	2551**0	0256201	0256204
------	---------	---------	---------	---------

x 10

Carrete x 200 m.

Rollo x 100 m.

Metraje

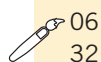

06 **1,83 €/u.**
32 **1,89 €/u.**

27,05 €/Carrete
27,05 €/Carrete



20 **1,02 €/m.** **1,23 €/m.**

SOPORTE DECORATIVO

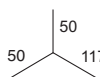
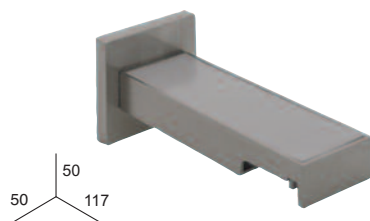

PROLONGADOR PARA SOPORTE DECORATIVO

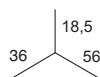

TAPÓN PARA RIEL ONDAS DECORATIVO

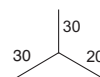
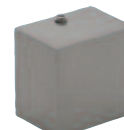

REF.	7607**4	7608**4	7609**4
------	---------	---------	---------

x 1

x 1

x 1

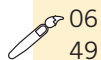

06 **10,60 €/u.**
49 **11,14 €/u.**

4,57 €/u.
4,80 €/u.

3,06 €/u.
3,19 €/u.

CORREDERA CON RUEDA
(Ristra 10 Unidades)

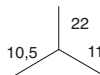
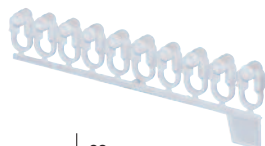

CORREDERA SIMPLE



CORDÓN CON SEPARADOR



NOVEDAD

PASO 80

PASO 60

TAPÓN PERFIL

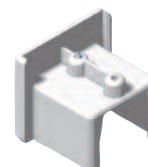

REF.	0689**0	0689**2	8076060	0103060	0321060	7605**0
------	---------	---------	---------	---------	---------	---------

x 400

x 20

x 100

Rollo x 500 m.

x 50

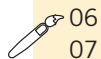

06 **20,74 €/Caja** **2,69 €/bl.**
07 **21,14 €/Caja** **2,69 €/bl.**

0,35 €/U. (Neto)

0,39 €/m.

0,43 €/m.



06 **1,08 €/u.**
32 **1,08 €/u.**

** Colores: 06= Blanco. 07= Negro. 20= Transparente. 32= Gris. 49= Acero inoxidable.
Código de envasado: 0= Granel. 1= Caja. 4= Bolsa de protección.



RIEL A MEDIDA PROFESIONAL PERFIL 7700. SIN CORDÓN



←----→	Ref.	Modalidad A	Modalidad B	Modalidad C
100 cm.	9085100	21,13 €	25,06 €	29,00 €
105 cm.	9085105	22,01 €	25,94 €	29,88 €
110 cm.	9085110	22,25 €	26,83 €	30,77 €
115 cm.	9085115	22,49 €	27,71 €	31,65 €
120 cm.	9085120	22,73 €	28,60 €	32,54 €
125 cm.	9085125	22,97 €	29,48 €	33,42 €
130 cm.	9085130	23,21 €	30,36 €	34,30 €
135 cm.	9085135	23,45 €	31,25 €	35,19 €
140 cm.	9085140	23,69 €	32,13 €	36,07 €
145 cm.	9085145	23,93 €	33,01 €	36,95 €
150 cm.	9085150	24,17 €	33,90 €	37,84 €
155 cm.	9085155	24,41 €	34,78 €	38,72 €
160 cm.	9085160	24,65 €	35,67 €	39,61 €
165 cm.	9085165	24,89 €	36,55 €	40,49 €
170 cm.	9085170	25,13 €	37,43 €	41,37 €
175 cm.	9085175	25,37 €	38,32 €	42,26 €
180 cm.	9085180	25,61 €	39,20 €	43,14 €
185 cm.	9085185	25,85 €	40,08 €	44,02 €
190 cm.	9085190	26,09 €	40,97 €	44,91 €
195 cm.	9085195	26,33 €	41,85 €	45,79 €
200 cm.	9085200	26,57 €	42,74 €	46,68 €
205 cm.	9085205	26,81 €	43,62 €	47,56 €
210 cm.	9085210	27,05 €	44,50 €	48,44 €
215 cm.	9085215	27,29 €	45,39 €	49,33 €
220 cm.	9085220	27,53 €	46,27 €	50,21 €
225 cm.	9085225	27,77 €	47,15 €	51,09 €
230 cm.	9085230	28,01 €	48,04 €	51,98 €
235 cm.	9085235	28,25 €	48,92 €	52,86 €
240 cm.	9085240	28,49 €	49,81 €	53,75 €
245 cm.	9085245	28,73 €	50,69 €	54,63 €
250 cm.	9085250	28,97 €	51,57 €	55,51 €
255 cm.	9085255	29,21 €	52,46 €	56,40 €
260 cm.	9085260	29,45 €	53,34 €	57,28 €
265 cm.	9085265	29,69 €	54,22 €	58,16 €
270 cm.	9085270	29,93 €	55,11 €	59,05 €
275 cm.	9085275	30,17 €	55,99 €	59,93 €
280 cm.	9085280	30,41 €	56,88 €	60,82 €
285 cm.	9085285	30,65 €	57,76 €	61,70 €
290 cm.	9085290	30,89 €	58,64 €	62,58 €
295 cm.	9085295	31,13 €	59,53 €	63,47 €
300 cm.	9085300	31,37 €	60,41 €	64,35 €

←----→	Ref.	Modalidad A	Modalidad B	Modalidad C
305 cm.	9085305	31,61 €	61,29 €	65,23 €
310 cm.	9085310	31,85 €	62,18 €	66,12 €
315 cm.	9085315	32,09 €	63,06 €	67,00 €
320 cm.	9085320	32,33 €	63,95 €	67,89 €
325 cm.	9085325	32,57 €	64,83 €	68,77 €
330 cm.	9085330	32,81 €	65,71 €	69,65 €
335 cm.	9085335	33,05 €	66,60 €	70,54 €
340 cm.	9085340	33,29 €	67,48 €	71,42 €
345 cm.	9085345	33,53 €	68,36 €	72,30 €
350 cm.	9085350	33,77 €	69,25 €	73,19 €
355 cm.	9085355	34,01 €	70,13 €	74,07 €
360 cm.	9085360	34,25 €	71,02 €	74,96 €
365 cm.	9085365	34,49 €	71,90 €	75,84 €
370 cm.	9085370	34,73 €	72,78 €	76,72 €
375 cm.	9085375	34,97 €	73,67 €	77,61 €
380 cm.	9085380	35,21 €	74,55 €	78,49 €
385 cm.	9085385	35,45 €	75,43 €	79,37 €
390 cm.	9085390	35,69 €	76,32 €	80,26 €
395 cm.	9085395	35,93 €	77,20 €	81,14 €
400 cm.	9085400	36,17 €	78,09 €	82,03 €
405 cm.	9085405	36,41 €	78,97 €	82,91 €
410 cm.	9085410	36,65 €	79,85 €	83,79 €
415 cm.	9085415	36,89 €	80,74 €	84,68 €
420 cm.	9085420	37,13 €	81,62 €	85,56 €
425 cm.	9085425	37,37 €	82,50 €	86,44 €
430 cm.	9085430	37,61 €	83,39 €	87,33 €
435 cm.	9085435	37,85 €	84,27 €	88,21 €
440 cm.	9085440	38,09 €	85,16 €	89,10 €
445 cm.	9085445	38,33 €	86,04 €	89,98 €
450 cm.	9085450	38,57 €	86,92 €	90,86 €
455 cm.	9085455	38,81 €	87,81 €	91,75 €
460 cm.	9085460	39,05 €	88,69 €	92,63 €
465 cm.	9085465	39,29 €	89,57 €	93,51 €
470 cm.	9085470	39,53 €	90,46 €	94,40 €
475 cm.	9085475	39,77 €	91,34 €	95,28 €
480 cm.	9085480	40,01 €	92,23 €	96,17 €
485 cm.	9085485	40,25 €	93,11 €	97,05 €
490 cm.	9085490	40,49 €	93,99 €	97,93 €
495 cm.	9085495	40,73 €	94,88 €	98,82 €
500 cm.	9085500	40,97 €	95,76 €	99,70 €

MODALIDAD A: Perfil, corredera simple (10/metro), tapones y soportes a techo (2 por metro).
 MODALIDAD B: Modalidad A más una corredera maestra.
 MODALIDAD C: Modalidad A más dos corredera maestra.

NOTA ACLARATORIA: El conjunto incorpora la tornillería de fijación de los soportes a techo. Si el cliente quiere el montaje a frente, se deducirán los soportes a techo y se incluirán las escuadras o soportes de pared del modelo y medida que el cliente solicite, así como la tornillería necesaria. Ambos componentes se facturarán aparte.

ACCESORIOS

PERFIL 7700 DE 6,00 m.



CORREDERA SIMPLE

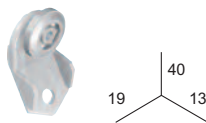

CORREDERA MAESTRA

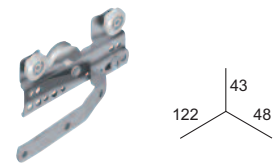

REF.	7700060	0275060	0276400
	x 20	x 50	x 10
	39,88 €/u.	0,63 €/u.	4,04 €/u.

CORREDERA AUXILIAR



TAPÓN PARA PERFIL

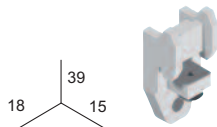

SOPORTE TECHO

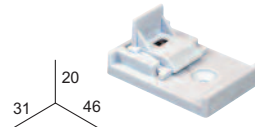

EMPALME

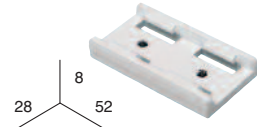

REF.	0277400	0278060	0252060	7604060
	x 10	x 50	x 25	x 10
	4,04 €/u.	0,42 €/u.	0,91 €/u.	1,83 €/u.

Colores: 06= Blanco. 40= Plata.
 Código de envasado: 0= Granel.

PERFIL 7288 Y ACCESORIOS

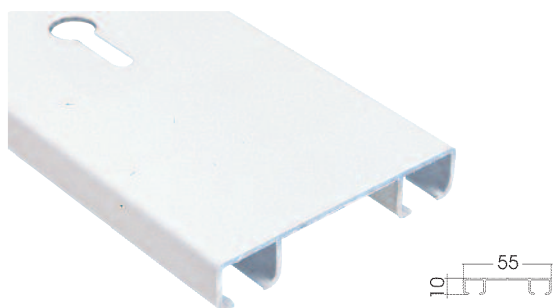

REF.	←----→		06
7288060	6 m.	x 12	42,99 €/u.
7289060	4 m.	x 12	29,40 €/u.
7290060	3 m.	x 12	21,56 €/u.
7291060	2 m.	x 12	14,55 €/u.

NOTA: Perforados de Ø10 cada 250 mm.

CORREDERA SIMPLE

CORREDERA FRENTE (Ristra 10 Unidades)

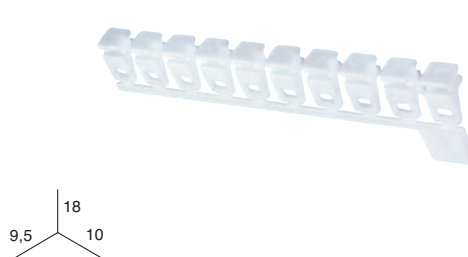
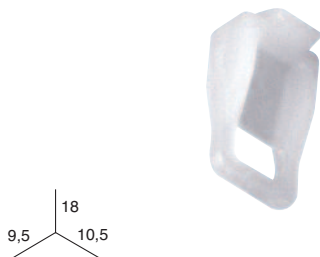

REF.	0906060	1072**0	1072**2
	x 500	x 400	x 20
06	9,52 €/Caja	14,71 €/Caja	1,47 €/bl.
07	-	15,46 €/Caja	1,54 €/bl.

CORREDERA CON RUEDA (Ristra 10 Unidades)

CORREDERA SIMPLE CON RUEDA

CORREDERA MAESTRA

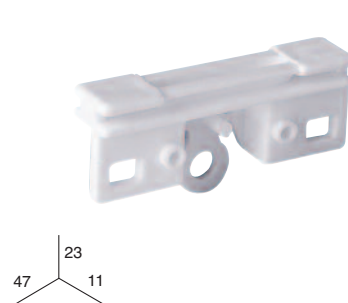
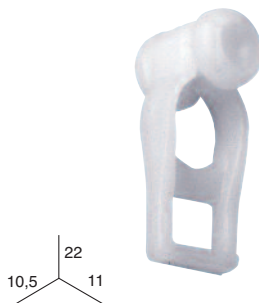
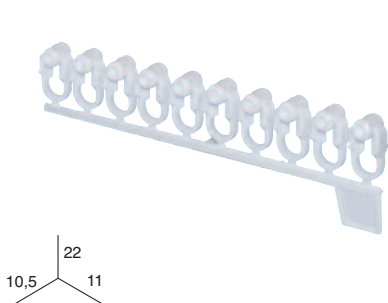

REF.	0689**0	0689**2	0907060	0907062	0962060
	x 400	x 20	x 500	x 20	x 50
06	20,74 €/Caja	2,69 €/bl.	29,72 €/Caja	2,27 €/bl.	0,21 €/u.
07	21,14 €/Caja	2,69 €/bl.	-	-	-

** Colores: 06= Blanco. 07= Negro.
Código de envasado: 0= Granel. 2= Blister.



PERFIL 7288 Y ACCESORIOS

CORREDERA MAESTRA CON RUEDAS

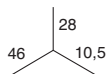
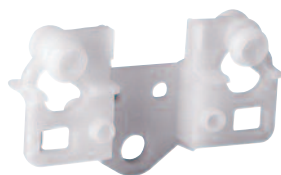

CORREDERA MAESTRA CON PATA CORTA



CORREDERA MAESTRA CON RUEDA Y PATA CORTA



REF.	0953060	0856060	0851060
	x 50	x 50	x 50
06	0,35 €/u.	0,67 €/u.	0,70 €/u.

TERMINAL PERFIL

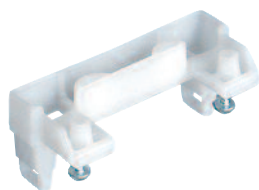

TOPE INTERMEDIO

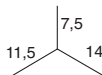

TOPE FINAL



REF.	7292060	7293060	7301060
	x 50	x 50	x 50
06	0,34 €/u.	8,04 €/Caja	6,70 €/Caja

POLEA INTERMEDIA

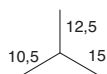

FIJADOR INTERMEDIO

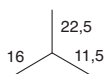

CORDÓN POLIÉSTER Ø2,5



REF.	1230400	0892060	2556060
	x 50	x 50	Carrete x 200 m.
06 40	- 0,91 €/u.	3,55 €/Caja -	29,40 €/Carrete -

Colores: 06= Blanco. 40= Plata.
Código de envasado: 0= Granel.



PERFIL 7288 Y ACCESORIOS

TENSOR

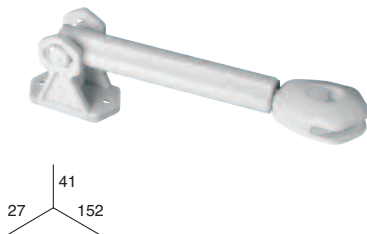

CONTRAPESO 30 grs.



CONTRAPESO CON GANCHO 50 grs.



REF.	0419060	0419062	0421060	0421062	0400060	0400062
	x 25	x 1	x 50	x 2	x 25	x 2
06	0,94 €/u.	4,34 €/bl.	0,61 €/u.	2,91 €/bl.	0,54 €/u.	2,70 €/bl.

CONTRAPESO 70 grs.

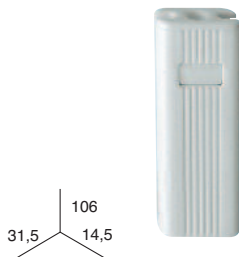

CONTRAPESO 110 grs.

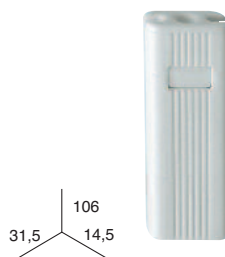

REF.	1204**0	1224060
	x 10	x 10
06	1,24 €/u.	1,45 €/u.
32	1,87 €/u.	-

ESQUEMA DEL MONTAJE CON CORDÓN P-7288

PARED

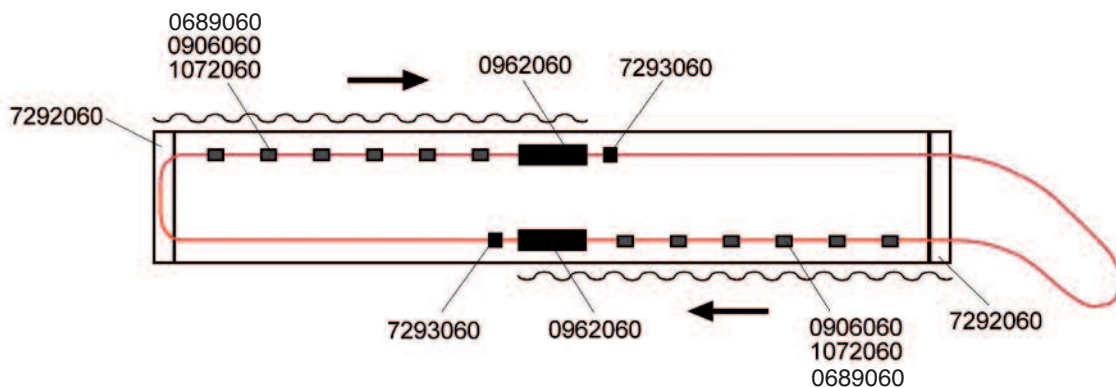

FRENTE

Colores: 06= Blanco. 32= Gris.
Código de envasado: 0= Granel. 2= Blister.



PERFIL 7269 Y ACCESORIOS (No admite montar con cordón)

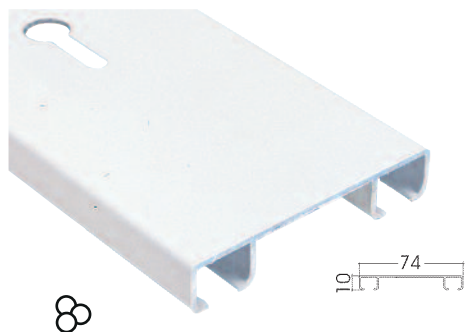

CORREDERA FRENTE (Ristra 10 Unidades)

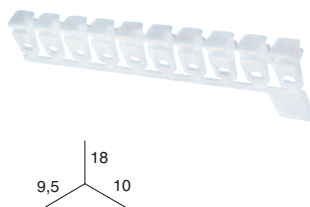

CORREDERA CON RUEDA (Ristra 10 Unidades)

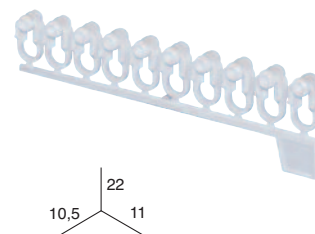

REF.	<---->		06
7269060	6 m.	x 12	51,56 €/u.
7302060	4 m.	x 12	34,38 €/u.
7303060	3 m.	x 12	25,88 €/u.
7304060	2 m.	x 12	17,26 €/u.

REF.	1072**0	1072**2	0689**0	0689**2
	x 400	x 20	x 400	x 20
06	14,71 €/Caja	1,47 €/bl.	20,74 €/Caja	2,69 €/bl.
07	15,46 €/Caja	1,54 €/bl.	21,14 €/Caja	2,69 €/bl.

NOTA: Perforados de Ø10 cada 250 mm.

NOTA: Disponemos de conjuntos de distintos componentes (ver en "rieles a medida")

CORREDERA SIMPLE



CORREDERA SIMPLE CON RUEDA



CORREDERA MAESTRA

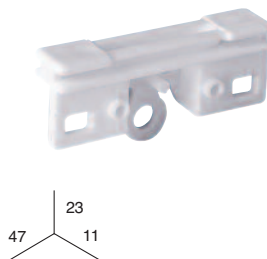

CORREDERA MAESTRA CON RUEDAS

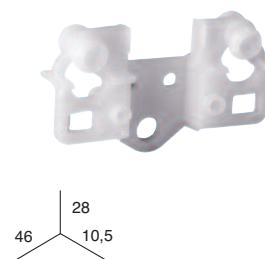

REF.	0906060	0907060	0907062	0962060	0953060
	x 500	x 500	x 20	x 50	x 50
06	9,52 €/Caja	29,72 €/Caja	2,27 €/bl.	0,21 €/u.	0,35 €/u.

CORREDERA MAESTRA CON PATA



CORREDERA MAESTRA CON RUEDA Y PATA

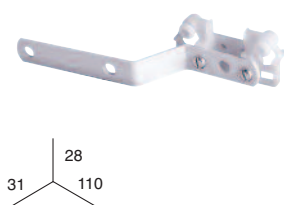

TOPE FINAL



FIJADOR INTERMEDIO



REF.	0913**0	0952**0	7301**0	0892060
	x 50	x 50	x 50	x 50
06	0,67 €/u.	0,69 €/u.	6,70 €/Caja	3,55 €/Caja
07	-	0,73 €/u.	7,04 €/Caja	-
40	0,56 €/u.	0,64 €/u.	-	-

Colores: 06= Blanco. 07= Negro. 40= Plata.
Código de envasado: 0= Granel. 2= Blister.

PERFIL 1078 Y ACCESORIOS

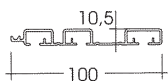
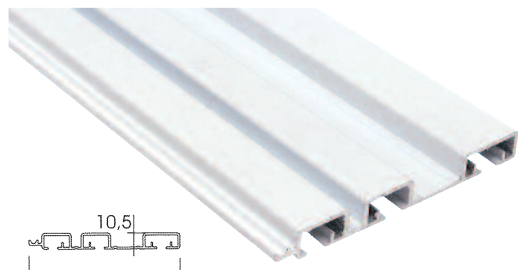

Perfil 1078, 3 vías
(para galería con P-7206)

REF.	←----→		06
1078060	6 m.	x 10	97,74 €/u.
7202060	4 m.	x 10	65,69 €/u.
7201060	3 m.	x 10	48,93 €/u.
7200060	2 m.	x 10	32,74 €/u.

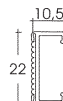

Perfil 7206

REF.	←----→		06
7206060	6 m.	x 50	29,10 €/u.
7205060	4 m.	x 50	19,61 €/u.
7204060	3 m.	x 50	14,62 €/u.
7203060	2 m.	x 50	9,84 €/u.

CORREDERA FRENTE
(Ristra 10 Unidades)

CORREDERA CON RUEDA
(Ristra 10 Unidades)

CORREDERA SIMPLE

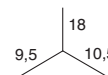
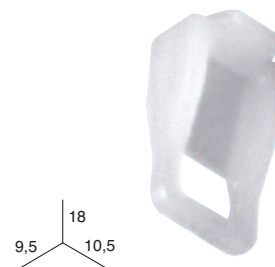
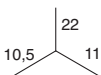
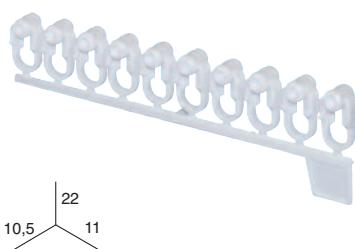
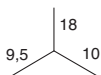
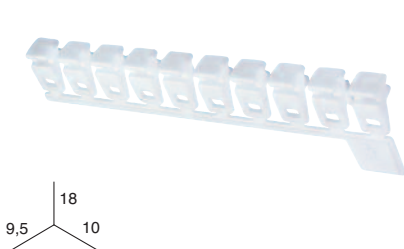

REF.	1072**0	1072**2	0689**0	0689**2	0906060
	x 400	x 20	x 400	x 20	x 500
06	14,71 €/Caja	1,47 €/bl.	20,74 €/Caja	2,69 €/bl.	9,52 €/Caja
07	15,46 €/Caja	1,54 €/bl.	21,14 €/Caja	2,69 €/bl.	-

MONTAJE DEL PERFIL 1078 (3 VÍAS) CON GALERÍA PERFIL 7206

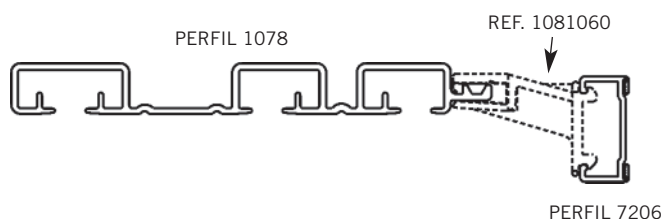

** Colores: 06= Blanco. 07= Negro.
Código de envasado: 0= Granel. 2= Blister.



PERFIL IO78 Y ACCESORIOS

CORREDERA SIMPLE CON RUEDA

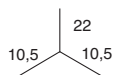
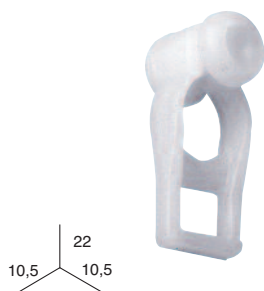

CORREDERA MAESTRA

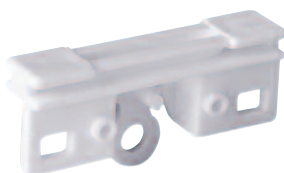

CORREDERA MAESTRA CON RUEDAS

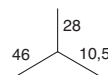
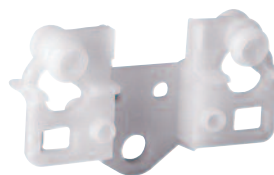

REF.	0907060	0907062	0962060	0953060
	x 500	x 20	x 50	x 50
06	29,72 €/Caja	2,27 €/bl.	0,21 €/u.	0,35 €/u.

CORREDERA MAESTRA CON PATA

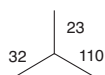

CORREDERA MAESTRA CON PATA CORTA

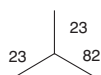

CORREDERA MAESTRA CON RUEDA Y PATA

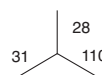

REF.	0913**0	0856060	0952**0
	x 50	x 50	x 50
06	0,67 €/u.	0,67 €/u.	0,69 €/u.
07	-	-	0,73 €/u.
40	0,56 €/u.	-	0,64 €/u.

CORREDERA MAESTRA CON RUEDA Y PATA CORTA

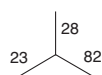

CORDÓN POLIÉSTER Ø2,5



TENSOR

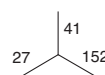
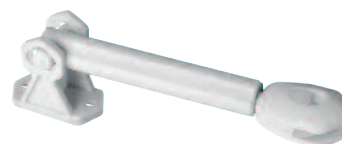

REF.	0851060	2556060	0419060	0419062
	x 50	Carrete x 200 m.	x 25	x 1
06	0,70 €/u.	29,40 €/Carrete	0,94 €/u.	4,34 €/bl.

** Colores: 06= Blanco. 07= Negro. 40= Plata.
Código de envasado: 0= Granel. 2= Blister.



PERFIL 1078 Y ACCESORIOS

CONTRAPESO 30 grs.

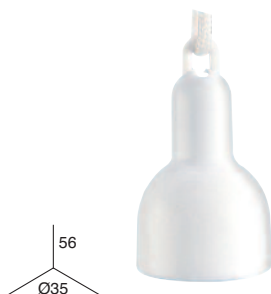

CONTRAPESO CON GANCHO 50 grs.



CONTRAPESO 70 grs.

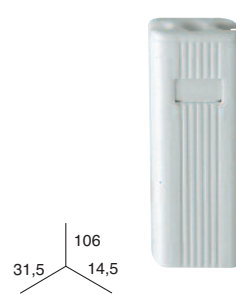

REF.	0421060	0421062	0400060	0400062	1204**0
	x 50	x 2	x 25	x 2	x 10
06	0,61 €/u.	2,91 €/bl.	0,54 €/u.	2,70 €/bl.	1,24 €/u.
32	-	-	-	-	1,87 €/u.

CONTRAPESO 110 grs.



TAPÓN

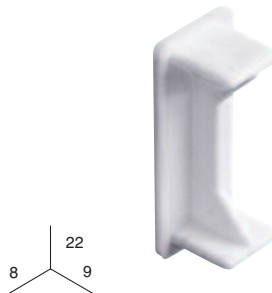

TERMINAL IZQUIERDA Y DERECHA

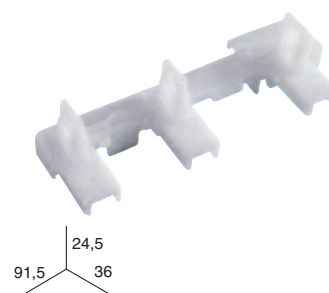

REF.	1224060	1521060	1080060
	x 10	x 50	x 12 juegos
06	1,45 €/u.	2,49 €/Caja	1,10 €/Juego

SOPORTE PERFIL 7206 A
PERFIL 1078

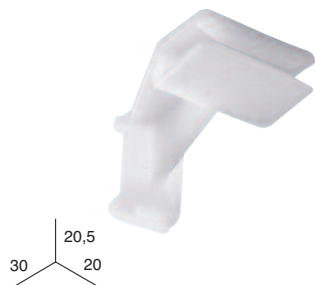

UNIÓN ESQUINA TECHO,
PARED PERFIL 7206

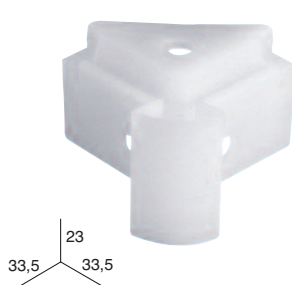

REF.	1081060	7210060
	x 25	x 25
06	0,23 €/u.	0,34 €/u.

** Colores: 06= Blanco. 32= Gris.
Código de envasado: 0= Granel. 2= Blister.



PERFILES 3 VÍAS Y ACCESORIOS

(No admite montar con cordón)

PERFIL 1129, 3 VÍAS (PERFORADO)

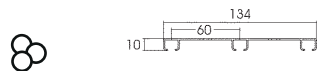

REF. 06

1129060 6 m. x 8 **74,08 €/u.**

1179060 4 m. x 8 **49,37 €/u.**

NOTA: Perforados de Ø10 cada 125 mm.

PERFIL 1131, 3 VÍAS (SIN PERFORAR)

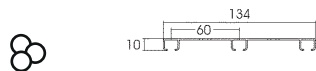
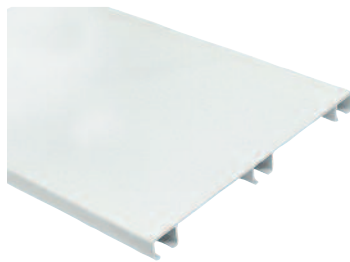

REF. 06

1131060 6 m. x 8 **72,22 €/u.**

1178060 4 m. x 8 **48,34 €/u.**

PERFIL 7576, 3 VÍAS ASIMÉTRICO (PERFORADO)

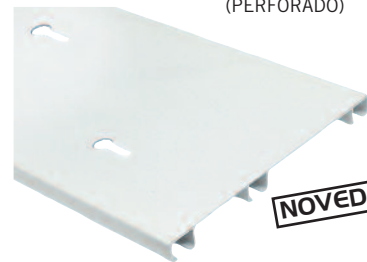

NOVEDAD

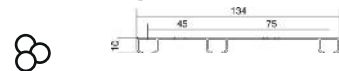

REF. 06

7576060 6 m. x 8 **74,08 €/u.**

7575060 4 m. x 8 **49,37 €/u.**

NOTA: Perforados de Ø10 cada 125 mm.

CORREDERA FRENTE (Ristra 10 Unidades)

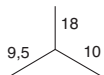
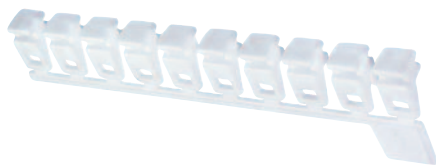

CORREDERA CON RUEDA (Ristra 10 Unidades)

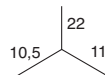
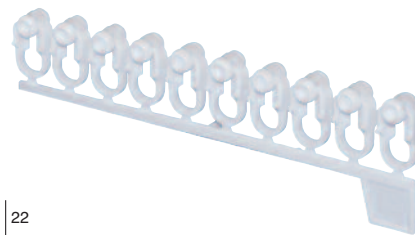

REF.	1072**0	1072**2	0689**0	0689**2
	x 400	x 20	x 400	x 20
06	14,71 €/Caja	1,47 €/bl.	20,74 €/Caja	2,69 €/bl.
07	15,46 €/Caja	1,54 €/bl.	21,14 €/Caja	2,69 €/bl.

CORREDERA SIMPLE

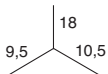

CORREDERA SIMPLE CON RUEDA

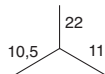

CORREDERA MAESTRA

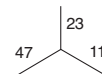
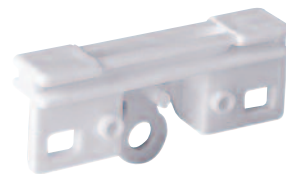

REF.	0906060	0907060	0907062	0962060
	x 500	x 500	x 20	x 50
06	9,52 €/Caja	29,72 €/Caja	2,27 €/bl.	0,21 €/u.

** Colores: 06= Blanco. 07= Negro.
Código de envasado: 0= Granel. 2= Blister.

PERFILES 3 VÍAS Y ACCESORIOS

CORREDERA MAESTRA CON RUEDAS

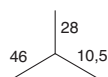

CORREDERA MAESTRA CON PATA

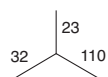

CORREDERA MAESTRA CON PATA CORTA

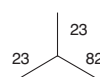

REF.	0953060	0913**0	0856060
	x 50	x 50	x 50
06	0,35 €/u.	0,67 €/u.	0,67 €/u.
40	-	0,56 €/u.	-

CORREDERA MAESTRA CON RUEDA Y PATA

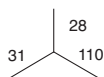

CORREDERA MAESTRA CON RUEDA Y PATA CORTA

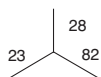

TOPE FINAL

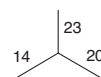

REF.	0952**0	0851060	7301**0
	x 50	x 50	x 50
06	0,69 €/u.	0,70 €/u.	6,70 €/Caja
07	0,73 €/u.	-	7,04 €/Caja
40	0,64 €/u.	-	-

FIJADOR INTERMEDIO

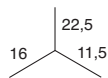

TOPE Y GUÍA HILOS

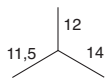

REF.	0892060	1560060
	x 50	x 50
06	3,55 €/Caja	6,23 €/Caja

** Colores: 06= Blanco. 07= Negro. 40= Plata.
Código de envasado: 0= Granel.



PERFIL 909 Y ACCESORIOS PARA GALERÍA

PERFIL 909

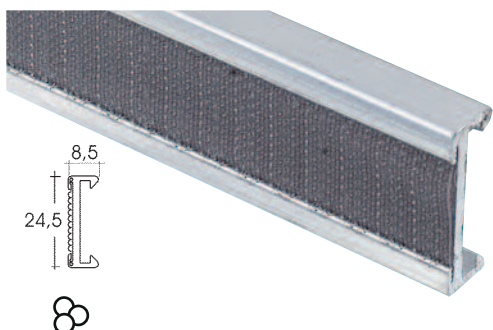

CINTA FELPA VELOUR SIN ADHESIVO



EMPALME



REF.	←----→		40
0909400	6 m.	x 50	27,26 €/u.
1090400	4 m.	x 50	18,21 €/u.
1089400	3 m.	x 50	13,67 €/u.
1088400	2 m.	x 50	9,15 €/u.

REF.	0991**0	0824060
	Carrete x 25 m.	x 25
06	0,38 €/m.	3,62 €/Caja
07	0,38 €/m.	-
32	0,38 €/m.	-

TAPÓN



UNIÓN ESQUINA
TECHO, PARED

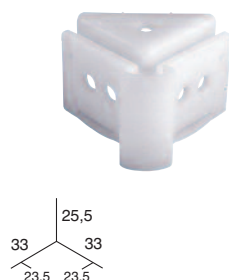

SOPORTE ESTOR
FRENTE-TECHO

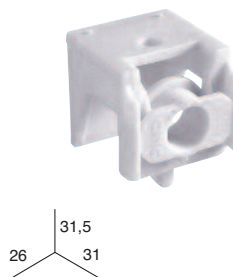

ESTRIBO



REF.	0801060	1060060	0800060	0990060
	x 50	x 25	x 50	x 50
06	2,05 €/Caja	0,36 €/u.	0,28 €/u.	5,69 €/Caja

PERFIL 1076 Y 7198 y ACCESORIOS PARA GALERÍA

PERFIL 1076 (CON CINTA GANCHO)

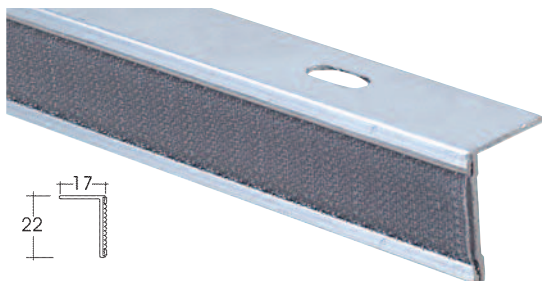

PERFIL 7198 (CON CINTA GANCHO)

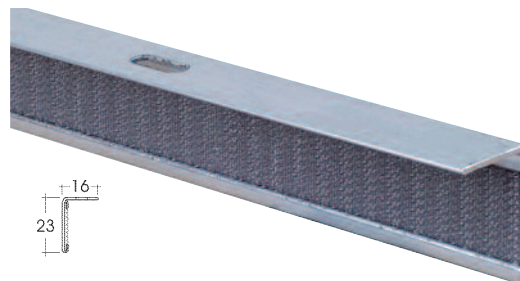

REF.	←----→		06	40
1076**0	6 m.	x 50	25,16 €/u.	20,35 €/u.
7209**0	4 m.	x 50	16,93 €/u.	13,70 €/u.
7208**0	3 m.	x 50	12,63 €/u.	10,23 €/u.
7207**0	2 m.	x 50	8,47 €/u.	6,89 €/u.

REF.	←----→		06	40
7198**0	6 m.	x 50	25,17 €/u.	20,36 €/u.
7196**0	4 m.	x 50	16,94 €/u.	13,69 €/u.
-	-	-	-	-
-	-	-	-	-

NOTA: Perforados de 12x5 cada 200 mm.

NOTA: Perforados de 12x5 cada 200 mm.



Colores: 06= Blanco. 07= Negro. 32= Gris. 40= Plata.
Código de envasado: 0= Granel.



PERFIL 7206 Y ACCESORIOS



PERFIL 7206 (CON CINTA GANCHO)



REF.	<---->		 06
7206060	6 m.	x 50	29,10 €/u.
7205060	4 m.	x 50	19,61 €/u.
7204060	3 m.	x 50	14,62 €/u.
7203060	2 m.	x 50	9,84 €/u.

CINTA FELPA VELOUR SIN ADHESIVO



REF.	0991**0	7299060
	Carrete x 25 m.	 x 50
06	0,38 €/m.	0,18 €/u.
 07	0,38 €/m.	-
32	0,38 €/m.	-

SOPORTE ESTOR FRENTE-TECHO

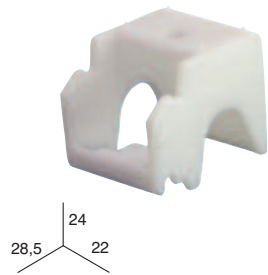

SOPORTE ESTOR FRENTE-TECHO

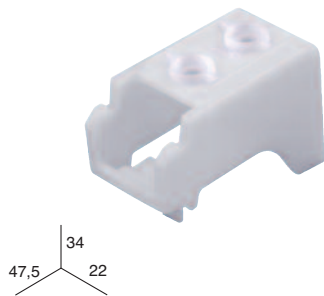





UNIÓN ESQUINA
TECHO, PARED PERFIL 7206

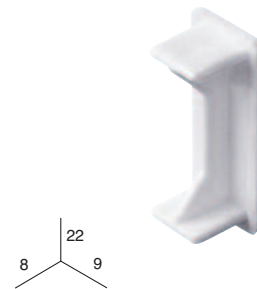

TAPÓN



REF.	1540060	7210060	1521060
	 x 25	 x 25	 x 50
 06	0,47 €/u.	0,34 €/u.	2,49 €/Caja



ACCESORIOS COMUNES

SOPORTE 3 cm. SIN ESTRIBO



SOPORTE 6 cm. SIN ESTRIBO

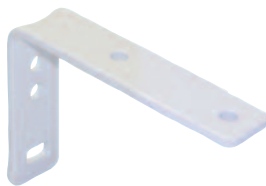

SOPORTE DOBLE 3-9 cm. SIN ESTRIBO



REF.	0770060	0771060	7187060
	x 50	x 50	x 50
06	0,33 €/u.	0,52 €/u.	0,66 €/u.

SOPORTE REFORZADO 3 cm. SIN ESTRIBO



SOPORTE REFORZADO 6 cm. SIN ESTRIBO



SOPORTE DOBLE REFORZADO 3-9 cm. SIN ESTRIBO



REF.	0808**0	0809**0	0943**0
	x 50	x 50	x 50
06	0,43 €/u.	0,52 €/u.	0,57 €/u.
40	0,43 €/u.	0,52 €/u.	0,57 €/u.

SOPORTE REFORZADO TRIPLE



PLACA EXTENSIÓN



SOPORTE DE PERFIL DE ALUMINIO 10 cm.



REF.	0854**0	0961**0	0961**2	7199060
	x 25	x 50	x 2	x 50
06	1,47 €/u.	0,42 €/u.	2,61 €/bl.	1,45 €/u.
40	1,42 €/u.	0,35 €/u.	2,38 €/bl.	-

** Colores: 06= Blanco. 40= Plata.
Código de envasado: 0= Granel.

ACCESORIOS COMUNES

SOPORTE DE PERFIL DE ALUMINIO 15 cm.

SOPORTE DE PERFIL DE ALUMINIO 19 cm.

SOPORTE DE PERFIL DE ALUMINIO 24 cm.

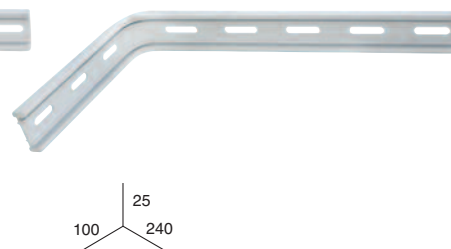
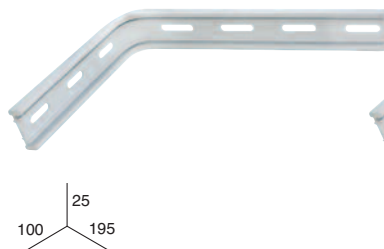
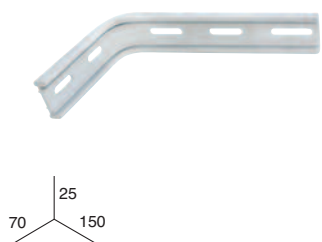

REF.	7229060	7230060	7231060
	x 50	x 25	x 25
06	1,68 €/u.	1,94 €/u.	2,17 €/u.

SOPORTE DE PERFIL DE ALUMINIO 15 cm. BASE LARGA

SUPLEMENTO PARA SOPORTES

SOPORTE TECHO DOBLE (para ref. 0993060)

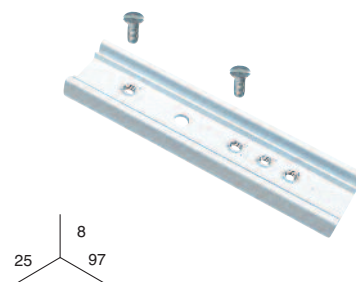
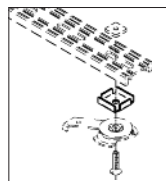
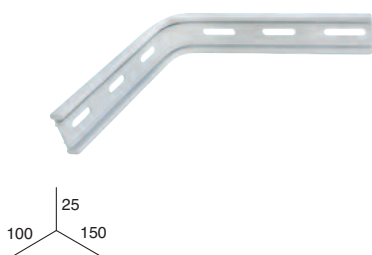

REF.	7226060	0898060	7275060
	x 25	x 25	x 25
06	1,83 €/u.	3,40 €/Caja	1,53 €/u.

SOPORTE TECHO TRIPLE (para ref. 0993060)

SOPORTE TECHO "CHYC" (0,70 m.) (Para perfiles 900, 908, 910 y 950)

SOPORTE TECHO "CHYC" (1,00 m.) (Para perfiles 900, 908, 910 y 950)

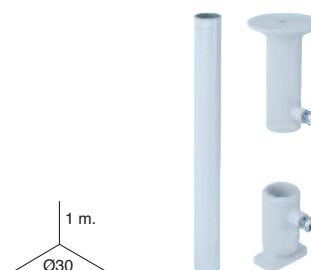
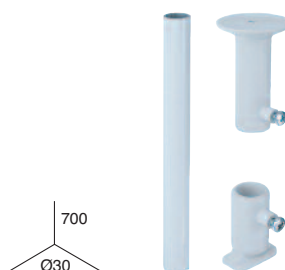
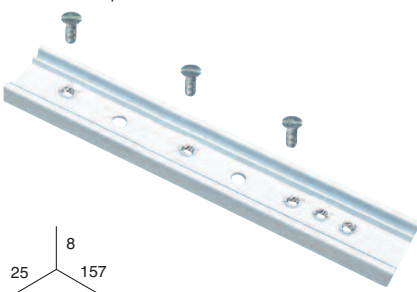

REF.	7276060	0963**0	0654060
	x 25	x 25	x 25
06	1,83 €/u.	3,38 €/u.	3,66 €/u.
40	-	3,14 €/u.	-

** Colores: 06= Blanco. 40= Plata.
Código de envasado: 0= Granel.



ACCESORIOS COMUNES

ACCESORIO PARA SOPORTE TECHO "CHYC"

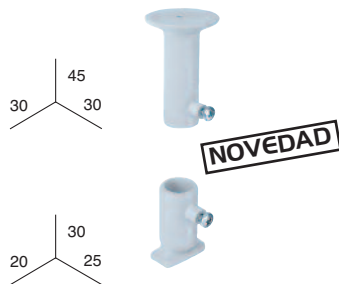

CASQUILLO RIOSTRA (Para perfiles 900, 908, 910 y 950)

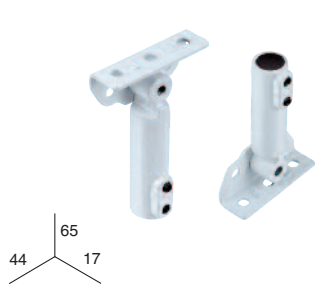

TUBO PARA CASQUILLO RIOSTRA



REF.	0665060	0744060	0437060	0437064
	x 10 juegos	x 6 juegos	x 10	
06	0,90 €/Juego	6,29 €/Juego	8,76 €/u.	3,50 €/m.

SOPORTE UNIVERSAL PARA VENTANAS

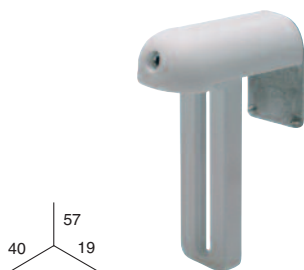

	0402**0	0402**2
	x 10	x 2
06	3,83 €/u.	10,61 €/bl.
07	3,93 €/u.	10,83 €/bl.
32	3,93 €/u.	10,83 €/bl.

EJEMPLO DE APILCACIÓN:

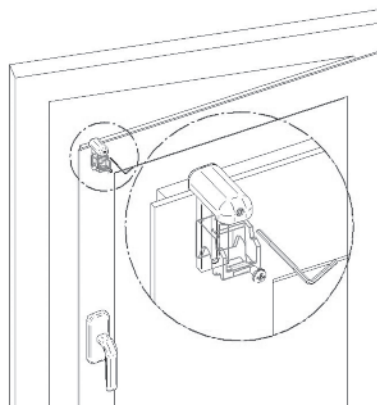

Nota: (espesor mínimo de la zona de anclaje 5 mm, espesor máximo 20 mm)

MONTAJE CASQUILLO RIOSTRA + TUBO



BALANCÍN

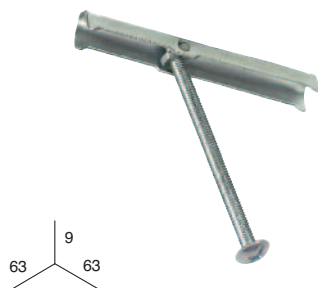

REF.	0934400
	x 25
40	0,41 €/u.

TOPE PORTATELA FIJO

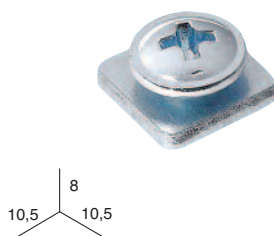

REF.	0917400
	x 100
	0,35 €/u.

SILICONA EN SPRAY 500 ml.



REF.	1888060
	x 12
	4,18 €/u. (Neto)

ALUMINIO

** Colores: 06= Blanco. 07= Negro. 32= Gris. 40= Plata.
Código de envasado: 0= Granel. 2= Blister.



ACCESORIOS COMUNES

MÁQUINA PARA CURVAR PERFILES DE ALUMINIO (950, Y 908/900)



NOVEDAD

MÁQUINA PARA CURVAR PERFILES DE ALUMINIO (Con almas para curvar)



Radio interior: 125 mm.

ALMAS PARA CURVAR PERFILES 900 Y 950 (1 juego: 9 almas)

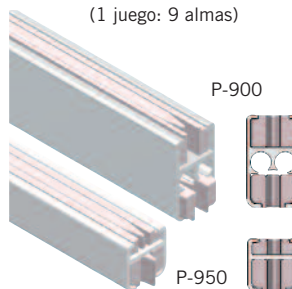

ALMAS PARA CURVAR PERFILES 908 (1 juego: 9 almas)

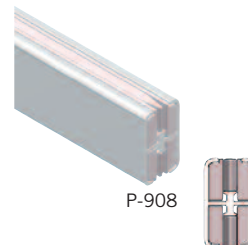

REF.	7597070	0563310	0513000	0514000
	x 1	x 1	x 1 juego	x 1 juego
PRECIO NETO	717,55 €/U. (Neto)	186,24 €/U. (Neto)	11,71 €/Juego (Neto)	9,59 €/Juego (Neto)

TIRADORES DE METACRILATO

TIRADOR Ø12 mm. x 0,75 m. PUNTA BISELADA. METACRILATO



REF.		€
7217200	x 25	10,05 €/u.

TIRADOR Ø12 mm. x 0,75 m. CON MANGO. METACRILATO



REF.		€
7232200	x 25	15,12 €/u.

TIRADOR Ø15 mm. x 0,75 m. PUNTA BISELADA. METACRILATO



REF.		€
7227200	x 25	12,98 €/u.

TIRADOR OCTOGONAL Ø15 mm. x 0,75 m. PUNTA ESFÉRICA. METACRILATO



REF.		€
7233200	x 25	14,97 €/u.

Colores: 20= Transparente.
Código de envasado: 0= Granel.



TIRADORES DE FIBRA, ALUMINIO Y PLASTICO

TIRADOR DE FIBRA Ø10 mm. BLANCO



NOVEDAD

NOVEDAD

	0,75 m.	1,00 m.	1,25 m.	1,50 m.	1,75 m.	2,00 m.	2,50 m.
REF.	0720060	0728060	0727060	0722060	0723060	0724060	0721060
	x 25	x 25	x 25	x 25	x 25	x 25	x 25
06	3,84 €/u.	4,12 €/u.	4,44 €/u.	4,77 €/u.	5,10 €/u.	5,41 €/u.	6,09 €/u.

TIRADOR DE ALUMINIO



	1,00 m.	1,25 m.	1,50 m.	1,75 m.	2,00 m.
REF.	0726060	0725060	0697060	0717060	0718060
	x 25	x 25	x 25	x 25	x 25
06	6,69 €/u.	7,44 €/u.	7,78 €/u.	8,41 €/u.	9,05 €/u.

TIRADOR PLASTIFICADO



	0,75 m.		1,00 m.		1,25 m.	1,50 m.
REF.	0847**0	0847**2	0992**0	0992**2	0998060	0946060
	x 25	x 2	x 25	x 2	x 25	x 25
06	1,49 €/u.	5,39 €/bl.	1,69 €/u.	5,55 €/bl.	1,93 €/u.	2,43 €/u.
07	1,66 €/u.	-	1,79 €/u.	-	-	-

Colores: **06**= Blanco. **07**= Negro.
Código de envasado: **0**= Granel. **2**= Blister.



CURVADO DE PERFILES

NOVEDAD

CURVADO "PERFIL 7478" (SOMFY)

PRECIOS NETOS

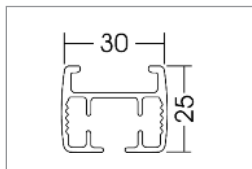

Hasta 2,00 m.		Desde 2,01 a 4,00 m.		Desde 4,01 m.	
CURVA PERFIL	ARCO PERFIL	CURVA PERFIL	ARCO PERFIL	CURVA PERFIL	ARCO PERFIL
60,00 €	75,00 €	75,00 €	90,00 €	90,00 €	120,00 €

CURVADO "PERFIL 8204" (CHYC)

PRECIOS NETOS

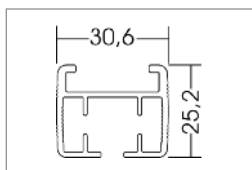

Hasta 2,00 m.		Desde 2,01 a 4,00 m.		Desde 4,01 m.	
CURVA PERFIL	ARCO PERFIL	CURVA PERFIL	ARCO PERFIL	CURVA PERFIL	ARCO PERFIL
54,00 €	66,00 €	66,00 €	81,00 €	81,00 €	102,00 €

CURVADO "PERFIL 7600" (ONDAS)

PRECIOS NETOS

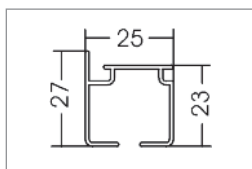

Hasta 2,00 m.		Desde 2,01 a 4,00 m.		Desde 4,01 m.	
CURVA PERFIL	ARCO PERFIL	CURVA PERFIL	ARCO PERFIL	CURVA PERFIL	ARCO PERFIL
45,00 €	60,00 €	60,00 €	75,00 €	75,00 €	96,00 €

NOTA: REFERENCIA PARA CURVADO DE PERFILES 7478, 8204 Y 7600: 9999994

CURVADO DEL "PERFIL 950"

PRECIOS NETOS

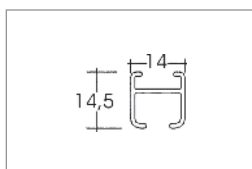

Hasta 2,00 m.		Desde 2,01 a 3,50 m.		Desde 3,51 a 5,00 m.		Desde 5,01 m.	
PERFIL	RIEL MONTADO	PERFIL	RIEL MONTADO	PERFIL	RIEL MONTADO	PERFIL	RIEL MONTADO
10,80 €	18,00 €	16,20 €	27,00 €	22,50 €	36,00 €	30,60 €	45,00 €

CURVADO DEL "PERFIL 908"

PRECIOS NETOS

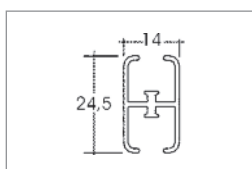

Hasta 2,00 m.		Desde 2,01 a 3,50 m.		Desde 3,51 a 5,00 m.		Desde 5,01 m.	
PERFIL	RIEL MONTADO	PERFIL	RIEL MONTADO	PERFIL	RIEL MONTADO	PERFIL	RIEL MONTADO
12,60 €	21,60 €	18,90 €	31,50 €	26,10 €	41,40 €	36,00 €	54,00 €

CURVADO DEL "PERFIL 900"

PRECIOS NETOS

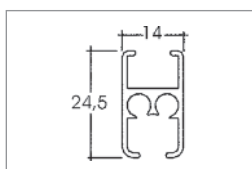

Hasta 2,00 m.		Desde 2,01 a 3,50 m.		Desde 3,51 a 5,00 m.		Desde 5,01 m.	
PERFIL	RIEL MONTADO	PERFIL	RIEL MONTADO	PERFIL	RIEL MONTADO	PERFIL	RIEL MONTADO
12,60 €	21,60 €	18,90 €	31,50 €	26,10 €	41,40 €	36,00 €	54,00 €

NOTA: REFERENCIA PARA CURVADO DE PERFILES 950, 908 Y 900: 9999998

LAS CURVAS EN ARCO DE LOS PERFILES 950, 908 Y 900 TENDRÁN UN INCREMENTO DEL 10% SOBRE LOS PRECIOS DE CURVADO



HOJA DE PEDIDO - RIELES PARA VENTANALES CURVOS

Fecha: _____ Código Cliente: _____

Cliente: _____

Dirección de envío: _____

Población: _____ C.P.: _____

Teléfono de contacto: _____ Fax: _____

Polígono Industrial "El Forseguer" s/n.
03460 BENEIXAMA (Alicante)

TEL. 902 411 111
FAX 902 411 110

Web: www.rielchyc.com
E-mail: rielchyc@rielchyc.com

- Elija el diseño que coincida con su ventanal. A continuación se presentan los diferentes esquemas para ventanales con dos curvas y otros diseños. Si ninguno de estos esquemas es el adecuado para usted, por favor, llame para que le aconsejemos.
- Utilice una cinta metálica y ponga las medidas en centímetros. Si las esquinas no están bien definidas, marque sobre la pared, así la medida será sobre el mismo punto (o ponga cinta adhesiva en la pared y marque sobre la cinta para evitar manchar la pared).
- Una vez tenga la medida del ventanal curvo envíela a nuestro correo electrónico (pedidos@rielchyc.com) o a nuestro fax (902 411 110). Nosotros le podemos asesorar sobre el tipo de perfil y soporte, y darle presupuesto para el riel.

ATENCIÓN AL CLIENTE: 902 411 111

FAX para PEDIDOS: 902 411 110

e-mail: rielchyc@rielchyc.com

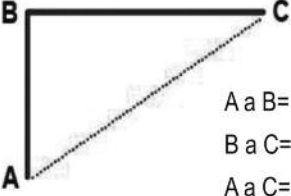
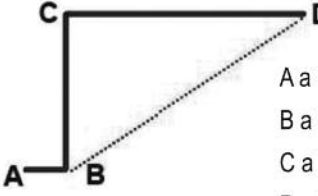
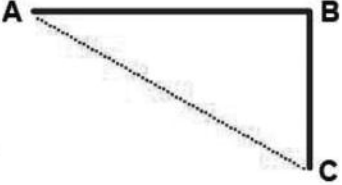
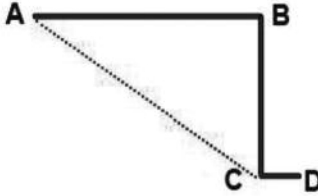
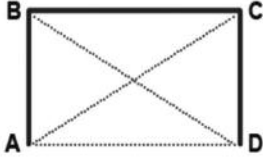
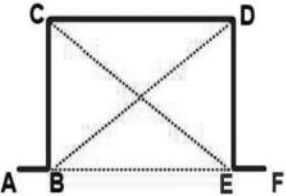
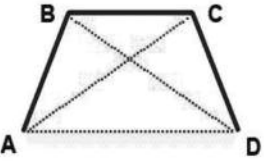
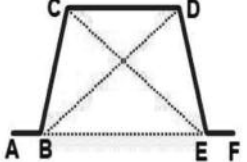
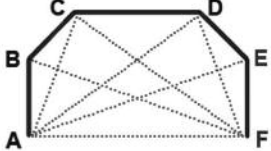
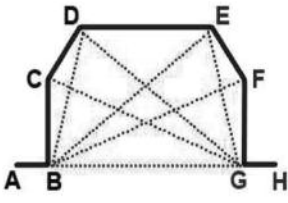
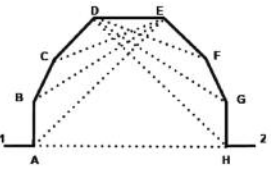
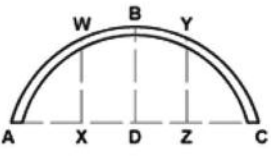
<p>Ventanal izquierdo tipo "L": Tipo 1</p>  <p>A a B= B a C= A a C=</p>	<p>Ventanal izquierdo tipo "L" con vuelta: Tipo 2</p>  <p>A a B= B a C= C a D= B a D=</p>	<p>Ventanal derecho tipo "L": Tipo 3</p>  <p>A a B= B a C= A a C=</p>
<p>Ventanal derecho tipo "L" con vuelta: Tipo 4</p>  <p>A a B= B a C= C a D= A a C=</p>	<p>Ventanal cuadrado: Tipo 5</p>  <p>A a B= B a C= C a D= A a D= A a C= B a D=</p>	<p>Ventanal cuadrado con vuelta: Tipo 6</p>  <p>A a B= B a C= C a D= D a E= E a F= B a E= B a D= C a E=</p>
<p>Ventanal ángulo: Tipo 7</p>  <p>A a B= B a C= C a D= A a D= A a C= B a D=</p>	<p>Ventanal ángulo con vuelta: Tipo 8</p>  <p>A a B= B a C= C a D= D a E= E a F= B a E= B a D= C a E=</p>	<p>Ventanal doble cara: Tipo 9</p>  <p>A a B= B a C= C a D= D a E= E a F= A a C= A a D= A a E= A a F= B a F= C a F= D a F= A a F=</p>
<p>Ventanal doble cara con vuelta: Tipo 10</p>  <p>A a B= B a C= C a D= D a E= E a F= F a G= G a H= B a G= B a D= B a E= B a F= C a G= D a G= E a G=</p>	<p>Ventanal doble cara: Tipo 11</p>  <p>MEDIDA PARED: A a B= B a C= C a D= D a E= E a F= F a G= G a H= DISTANCIAS: A a E= B a E= C a E= H a D= G a D= F a D= A a H=</p> <p>MEDIDAS OPCIONALES PARA LA VUELTA: 1 a A= 2 a H=</p>	<p>Ventanal arco: Tipo 12</p>  <p>A a C= B a D= W a X= Y a Z= A a X= C a Z=</p>

TIPO DE VENTANAL ELEGIDO:

NOTA: Este producto está hecho a medida y no puede ser cambiado o devuelto. Por favor consulte nuestros Términos y Condiciones para productos a medida.



СНУС

GAMA DE MOTORIZACIÓN DE CORTINAS "GLYDEA"



ALUMINIO

RIEL CHYC, incluye en su catálogo, la línea de rieles motorizados de la acreditada marca **SOMFY**, referente en el mercado internacional en automatismos de interior y exterior.



Las cortinas motorizadas se están convirtiendo en una característica habitual de los proyectos con estilo, ya sean hoteles de calidad, viviendas o centros de reuniones y conferencias a los que aportan imagen y funcionalidad.



Glydea es robusto, cómodo, fiable y permite soluciones personalizadas de vanguardia. **Glydea** mejora la imagen de un centro de reunión y hace que el trabajo del personal sea más fácil.



En su versión automática contribuye a lograr ahorro energético y seguridad, ampliando la duración de las cortinas.

La flexibilidad de este conjunto es, sin duda, su mejor cualidad porque permite ofrecer todas las soluciones para responder a los proyectos más exigentes. Detallamos las propiedades derivadas de esta flexibilidad:

- **Adaptabilidad:** permite la personalización del producto con un solo riel para distintos tipos y formas de cortina.

TIPOS DE CORTINA

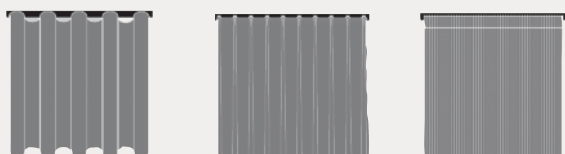

TIPOS DE APERTURA: LATERAL Y CENTRAL



- **Dos tipos de motorización y gran variedad de sistemas de control.**

	MOTOR	APERTURA LATERAL	APERTURA CENTRAL
	GLYDEA™ 35	35 Kg. / 10 m.	35 Kg. / 10 m.
	GLYDEA™ 60	60 Kg. / 10 m.	60 Kg. / 10 m.

		
Compatibilidades estándar. Motores WT. <ul style="list-style-type: none"> Automatización para hoteles u hogares, relés de conmutación de CA o contacto seco. Inversores y sistemas de control de CA del mercado. Inversores de doble o triple botón. Transmisores por infrarrojos. 	Glydea™ puede equiparse con módulos conectables para interactuar con tecnologías de control adicionales. Motores DCT. Receptores RTS, compatibilidad con todos los controles Somfy RTS.	Módulo RS485, para interactuar con los sistemas de comunicación de automatización domésticos más habituales.

- **Instalación fácil:** ocultación de motor en falsos techos, posición a derecha o a izquierda, final de carrera ajustable, soporte de techo One Touch o giratorio (ver esquema en páginas posteriores), transformador de 24V integrado.

MONTAJE ESTÁNDAR



MONTAJE EN FALSO TECHO



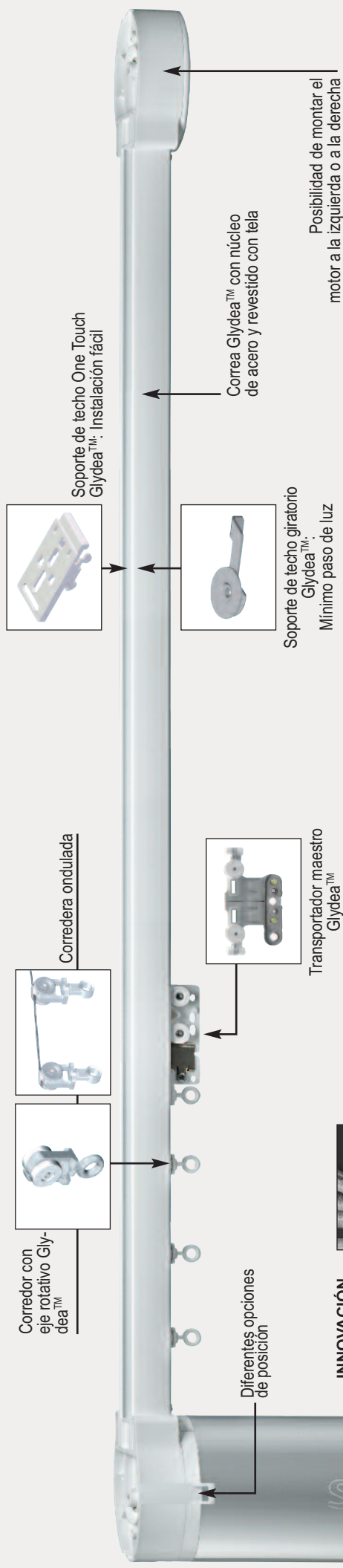

La sofisticación de este riel se refleja en sus formas sencillas y las líneas elegantes del motor y el perfil.

Estética

- Mínimo espacio de luz gracias al diseño del riel y al soporte de techo giratorio.
- Opción de finales de carrera ajustables.
- Bajo nivel de ruido del riel motorizado (<44 dB(A), con arranque y parada suaves).

Innovación

- El diseño patentado de la cubierta del perfil oculta el cableado y protege los conectores y los módulos de control dentro del motor.
- Módulos de gestión conectables para una gran variedad de sistemas de control.
- Posibilidad de accionamiento manual que desacopla automáticamente el eje de accionamiento del motor para un funcionamiento manual, preservando la tela.

Eficiencia

- Función "Touch Motion", para abrir y cerrar la cortina simplemente tirando de la tela.
- Función "My", para llevar automáticamente la cortina hasta una posición preferida.
- Velocidad ajustable: de 12,5 cm/s a 20 cm/s.

Diseño resistente y flexibilidad

- Botones de ajuste y cableado no accesibles para el usuario final.
- No se necesita mantenimiento tras la instalación.
- Extensa variedad de componentes para adaptarse a diferentes tipos de tejido.
- Testado para un funcionamiento de más de 5.000 ciclos.

Calidad

- CHYC garantiza este producto durante 5 años, contando con la garantía internacional de SOMFY.
- Esta gama cuenta con las certificaciones internacionales siguientes:



INNOVACIÓN SOMFY
Posibilidad de accionamiento manual



Diseño de cubierta sobrio
— Función Touch Motion
— Función My (posición preferida)
— Transformador integrado



INNOVACIÓN SOMFY
Flexibilidad de control



Especificaciones técnicas

1. Cuadro de la características

MOTOR	GLYDEA™ 35 DCT	GLYDEA™ 35 WT	GLYDEA™ 60e DCT	GLYDEA™ 60e WT
Características principales del motor				
Arranque suave	●	●	●	●
Parada suave			●	●
Posición intermedia			●	
Funcionamiento manual	●	●	●	●
Touch Motion			●	
Finales de carrera automáticos	●	●	●	●
Back Release	●	●		●
Límites ajustables			●	
Velocidad ajustable			●	●
Opciones de control				
Conmutación de CA		●		●
3 contactos secos normalmente abiertos	●		●	
2 contactos secos normalmente abiertos	●		●	
2 contactos secos normalmente abiertos modo cíclico	●		●	
Control principal y de grupo e individual de contacto seco	●		●	
Infrarrojos	●		●	
Tandem (próximamente)			●	
Tecnología digital RS485 (primer semestre 2012)	●		●	
Radio Tecnología Somfy (RTS)	●		●	
Control solar	●		●	
Control horario	●	●	●	●
Características de ajustes e instalación				
Ajuste con botones a través del motor			●	●
Indicadores LED			●	●
Cambio de sentido de giro del motor	●	●	●	●
Montaje invertido	●	●	●	●

Características principales del riel motorizado

MOTOR	GLYDEA™ 35 DCT	GLYDEA™ 35 WT	GLYDEA™ 60e DCT	GLYDEA™ 60e WT
Rango de voltaje	250 V 50 HZ	250 V 50 HZ	250 V 50 HZ	250 V 50 HZ
Velocidad lineal media de	20 cm/s	20 cm/s	12,5 / 15 / 17 / 20 cm/s	12,5 / 15 / 17 / 20 cm/s
Consumo eléctrico	60 W	60 W	120 W	120 W
Tipo de cable de alimentación	Cable de 3 hilos	Cable de 4 hilos	Cable de 3 hilos	Cable de 4 hilos
Conector de control	RJ12		RJ12	
Voltaje en la línea de control DCT (suministrado por el motor)	3,3 VDC	250 V CA	3,3 VDC	250 V CA
Nivel de ruido del riel motorizado ⁽¹⁾	50 dB(A)	50 dB(A)	44 dB(A) ⁽²⁾	44 dB(A) ⁽²⁾
Certificaciones	c TUV us, CCC, CE, C-Tick, SASO			
Longitud máxima de riel	10 m	10 m	10 m	10 m
Número máximo de uniones	2	2	2	2

⁽¹⁾ Nivel de presión de sonido de acuerdo con la norma de medición de Somfy.

⁽²⁾ A 15 cm/s.

2. Dimensiones del motor

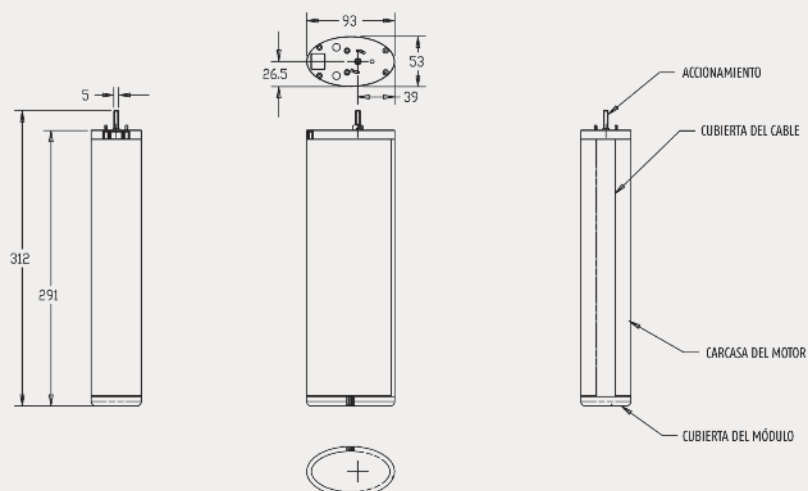

3. Tipos de montaje

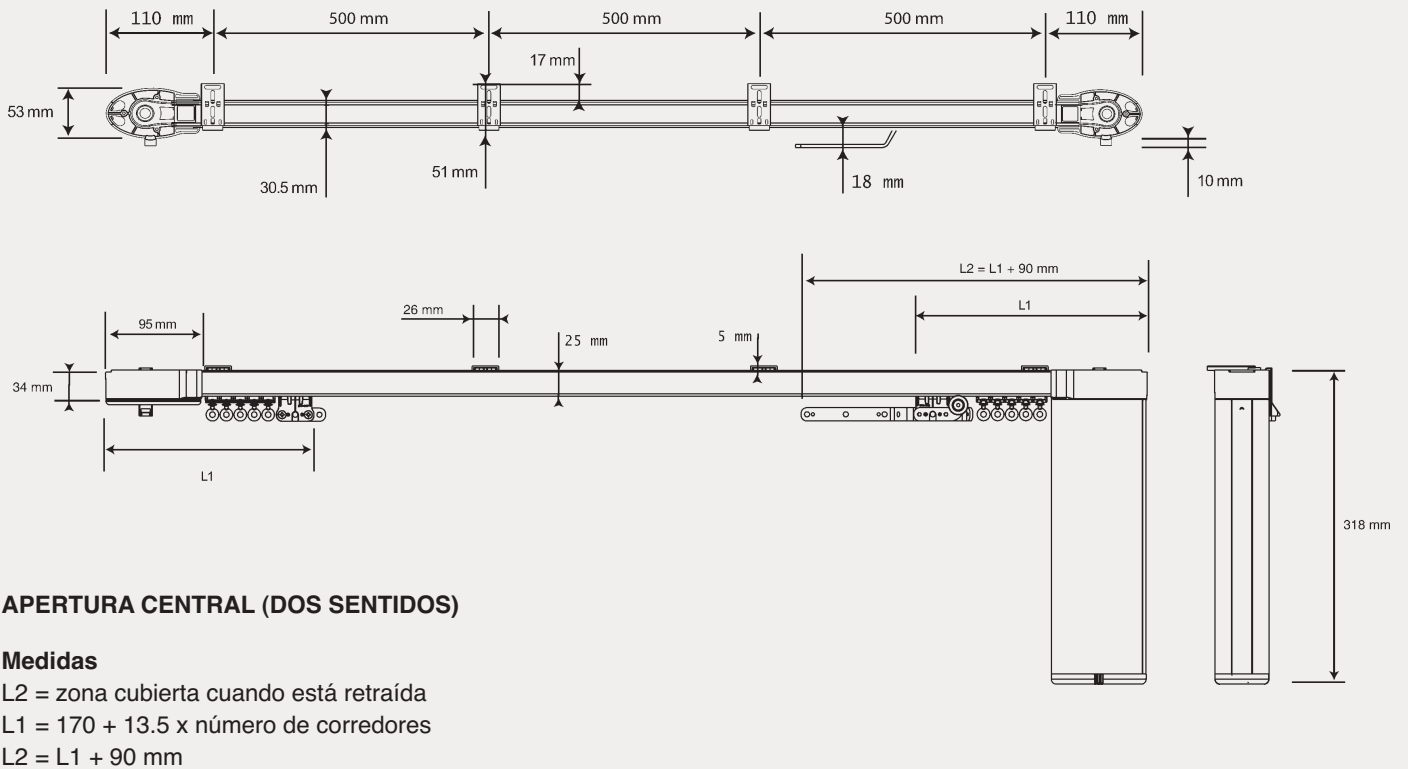
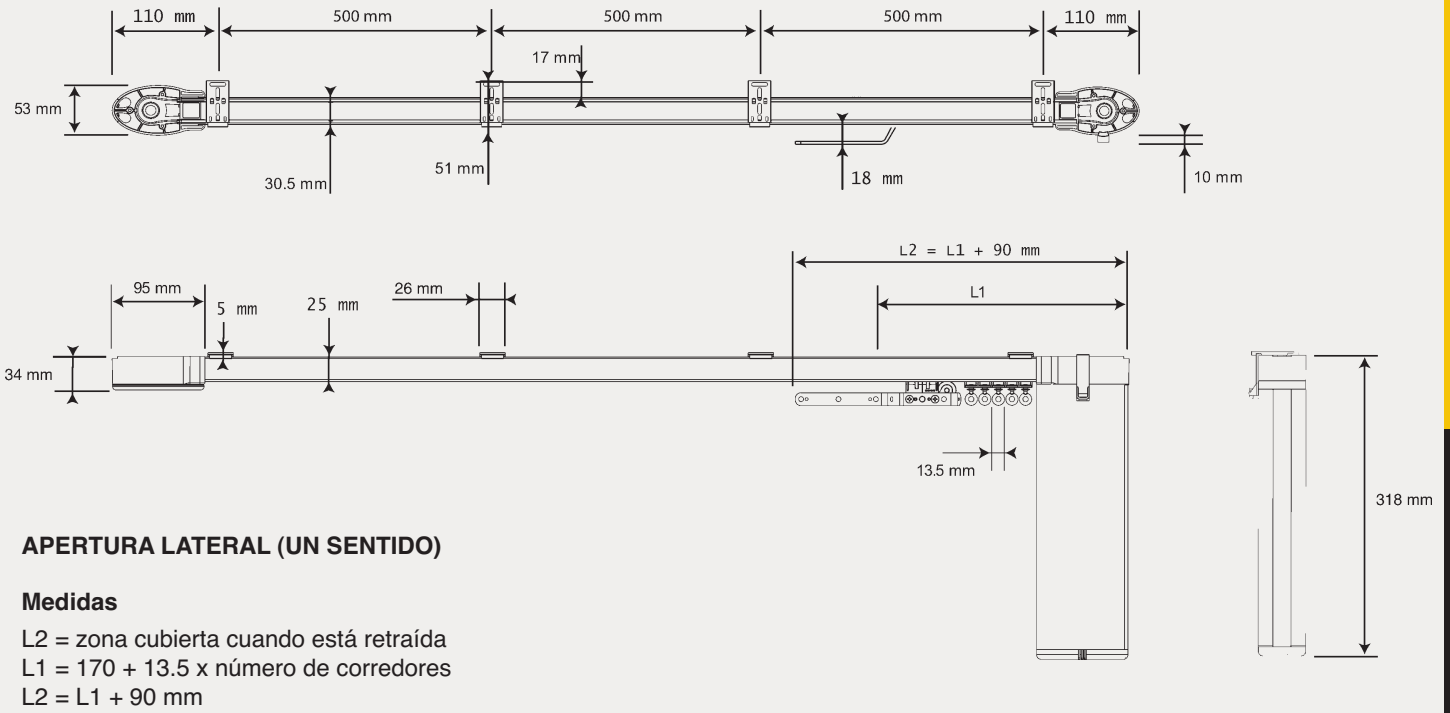

NOTA: Para montajes de cortina ondulada, consultar.

Tipos y dimensiones de soportes

4. Soportes

SOPORTE DE TECHO ONE TOUCH

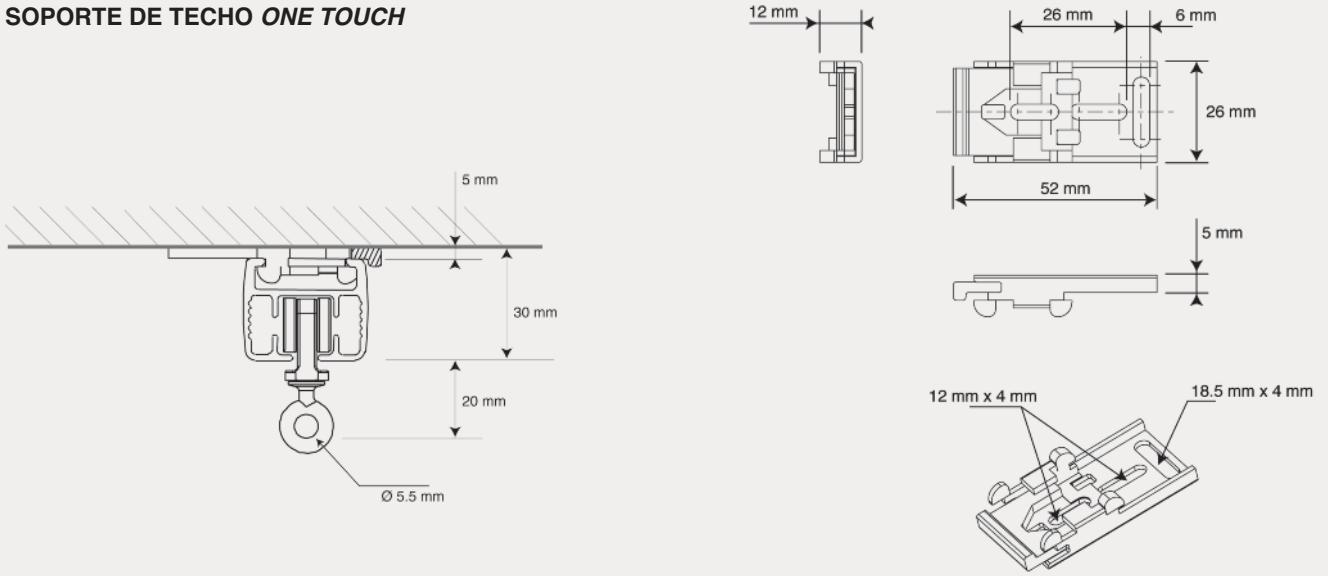

SOPORTE DE TECHO GIRATORIO

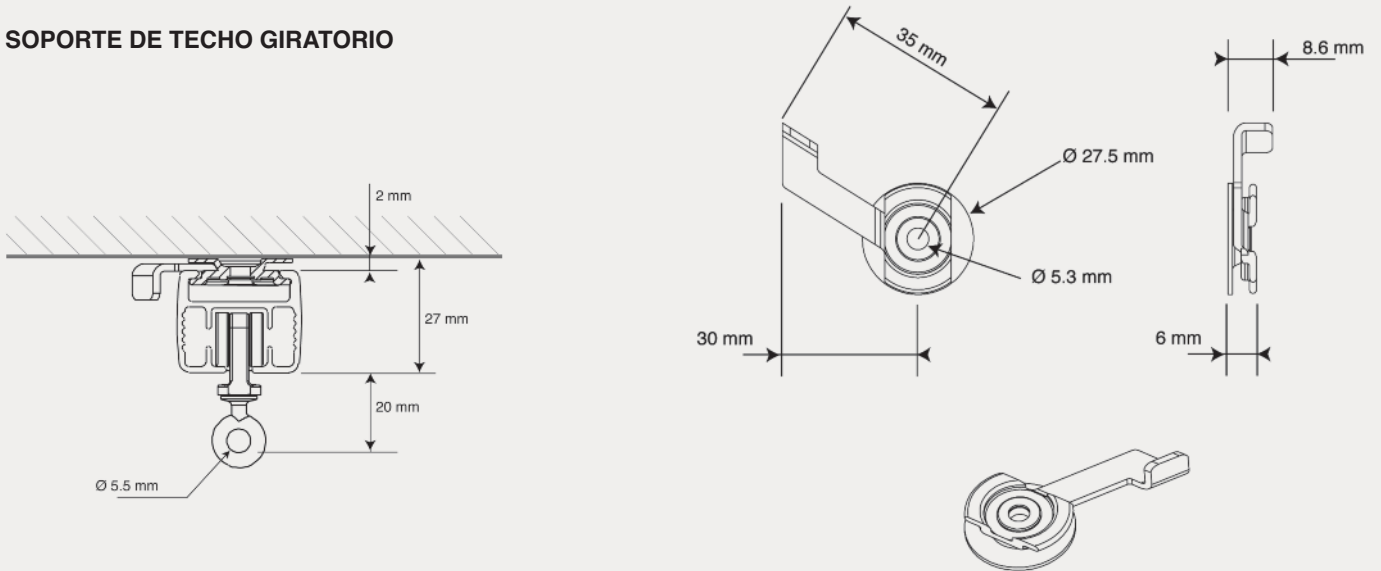

SOPORTE DE PARED AJUSTABLE

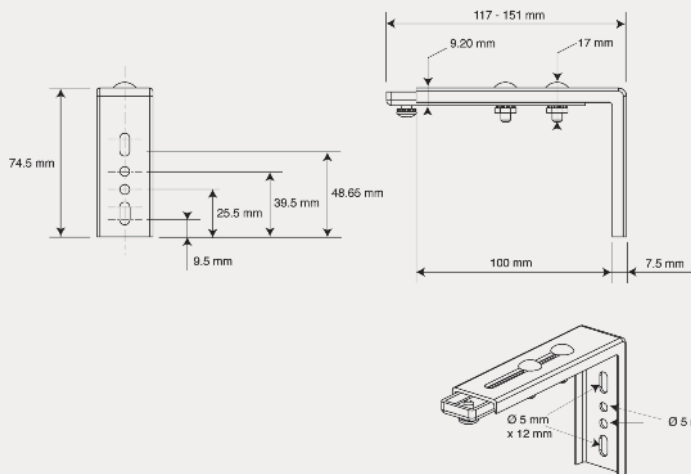

SOPORTE DOBLE DE PARED AJUSTABLE

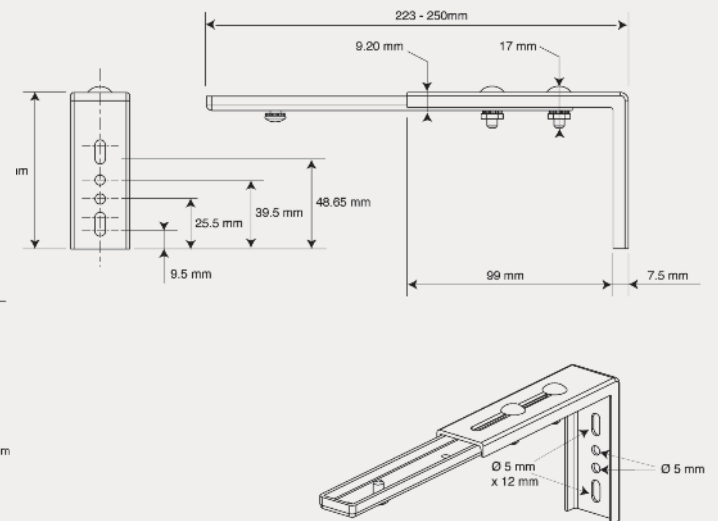

Configuración de los componentes necesarios y adecuados para el montaje del riel

Seguiremos los pasos siguientes para configurar el riel atendiendo a las características del montaje:

PASO 1: Selección del motor

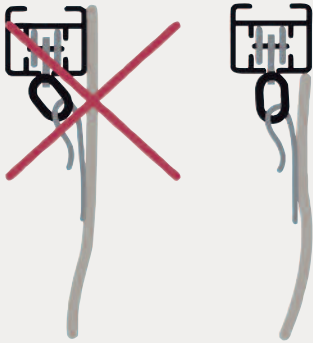

Colocación correcta para evitar rozamientos y daños en el tejido y en el riel motorizado.

La elección del motor requiere determinar la capacidad de carga necesaria. Para ello tendremos en cuenta los siguientes factores:

- El tipo de apertura y longitud del riel.
- Peso de la cortina: Kg/m² de tela x m² de cortina.
- Capacidad de movimiento transversal, referente a la existencia de rozamiento por contacto de la tela con el riel o con el dosel del riel. Es importante una correcta colocación (ver dibujo).

	MOTOR	REFERENCIA
	MOTOR 35 DCT: Contacto seco, unidad de cable de 1,5 m de 3 hilos (Para cortinas con peso hasta 35 kg.)	8064000
	MOTOR 35 WT: Control de conmutación CA, unidad de cable de 1,5 m de 4 hilos (Para cortinas con peso hasta 35 kg.)	8065000
	MOTOR 60 DCT: Contacto seco, unidad de cable de 1,5 m de 3 hilos (Para cortinas con peso hasta 60 kg.)	8066000
	MOTOR 60 WT: Control de conmutación CA, unidad de cable de 1,5 m de 4 hilos (Para cortinas con peso hasta 60 kg.)	8067000

PASO 2. Seleccionar los soportes

	SOPORTE DE TECHO GIRATORIO GLYDEA™ REFERENCIA: 8080400
	Para minimizar el paso de la luz (máx. 2mm). Acero cincado.

	SOPORTE AJUSTABLE DE PARED GLYDEA™ REFERENCIA: 8082060
	Utilizado con cualquier soporte de techo. Acero, color blanco

	SOPORTE DE TECHO ONE TOUCH GLYDEA™ REFERENCIA: 8081060
	Para una fácil instalación. Acero, color blanco

	SOPORTE DOBLE AJUSTABLE DE PARED GLYDEA™ REFERENCIA: 8083060
	Utilizado con cualquier soporte de techo. Acero, color blanco

PASO 3. Seleccionar los controles

RADIO CONTROL RTS

Control individual con emisor y/o pulsador de pared
(Motor DCT + receptor RTS 433)

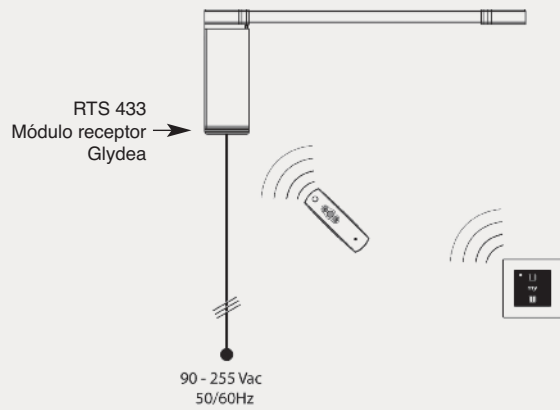

Control de grupo e individual con emisor de 4 canales
(Motores DCT + receptor RTS 433)

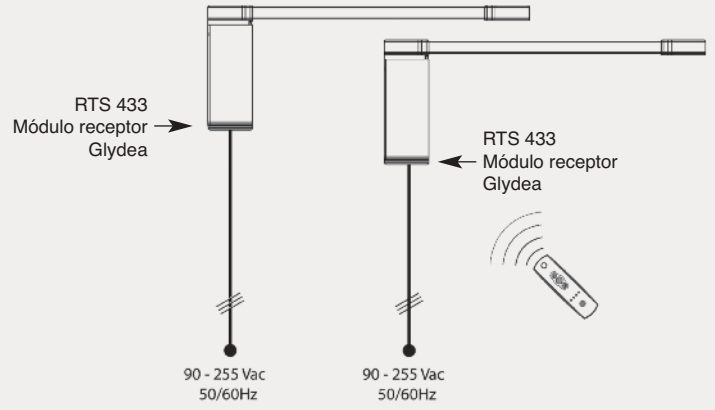

CONTROL POR CABLE

Control de grupo y/o individual DCT con pulsador control CA utilizando Módulo DCT Glydea™

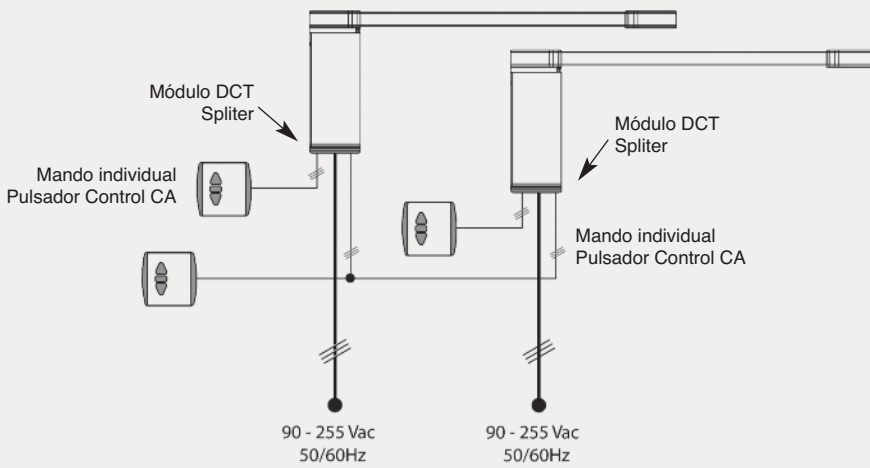

Mando individual con pulsador de CA

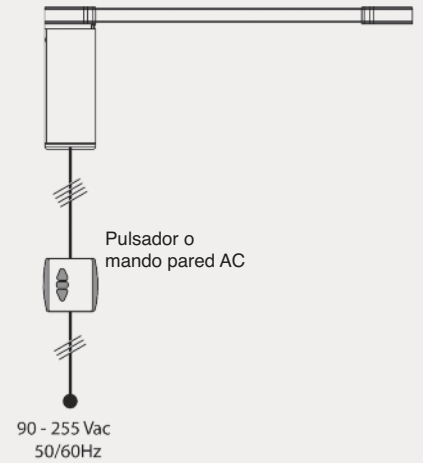

Mando individual o de grupo con pulsador de CA

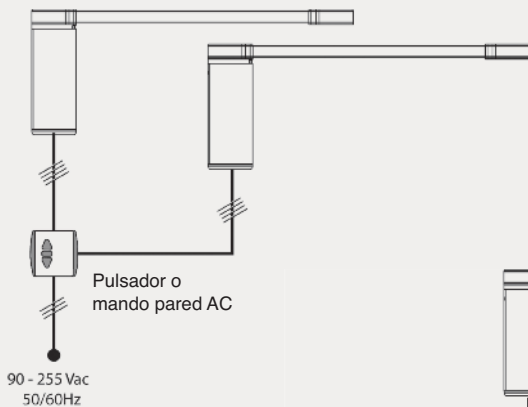

Control de grupo y/o individual WT con pulsador control CA

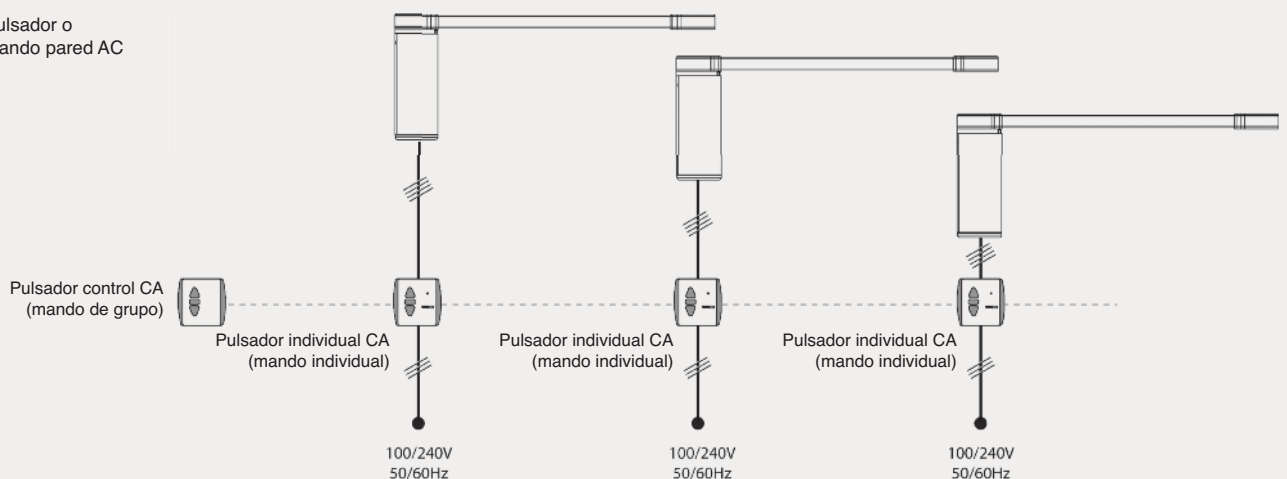

TARIFICACIÓN DEL MONTAJE A MEDIDA Y TARIFA DE COMPONENTES (PRECIO NETO)

1. Ver la longitud del riel, su tipo de apertura y multiplicar los metros lineales por los precios del apartado 1.
2. Elección del tipo de soporte. Atendiendo al tipo de montaje (a pared o techo), determinar el número necesario de soportes y multiplicar por su precio, teniendo en cuenta que el montaje a pared debe incluir junto al soporte de pared elegido uno de techo (ver nota final de apartado 2).
3. Elección de la motorización. La motorización puede ser por radio control o por cable:
 - 3.1. Radio control. En este caso necesitamos uno de los dos motores de la primera sección del apartado 3, dependiendo del peso total de la cortina. Si es inferior a 35 kg. será el motor 35 DCT; si es superior a 35 kg. y no excede los 60 kg. utilizaremos el motor 60 DCT. Sea cual sea el motor elegido, hay que añadir el módulo RTS y un mando. Para instalaciones de un solo riel, optaremos por el mando a distancia de un canal (rf. 8093000) o por el módulo RTS de pared (rf. 8092000) que aunque sea de posición fija, es de radio control y no necesita instalación de cableado. Para instalación de varios rieles, podemos optar por un único mando de distintas frecuencias (rf. 8094000) o por el mando individual en cada uno de ellos.
 - 3.2. Por cable. En este caso aplicamos para la elección del motor los mismos criterios que en los DCT. Para instalaciones de un solo riel utilizaremos el pulsador fijo individual y para montajes de varios conjuntos podremos optar por una instalación con manejo desde el pulsador individual de cada riel (rf. 8095000) o desde un pulsador que controle al resto (rf. 8096000). Esta instalación requiere cableado desde el motor a los pulsadores, pero no el módulo RTS.

1. Riel montado sin soportes y sin motor

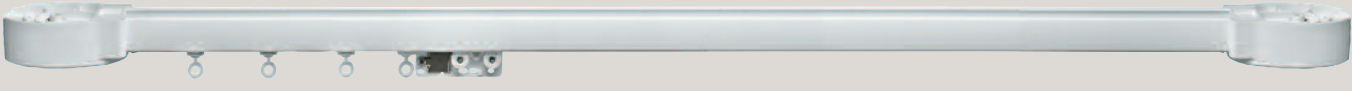

	
Riel montado con apertura lateral o central, sin soportes y sin motorizar	CONSULTAR

El precio anterior incluye los componentes del riel no configurables detallados a continuación:

	POLEA GLYDEA™ Conjunto de polea para ponerse en el lado opuesto al del motor Ref.: 8070060 8,86 €/un.		JUNTA DE UNION GLYDEA™ Para unir dos rieles Ref.: 8074060 3,10 €/un.		BRAZO RECTO GLIDEA GLYDEA™ Acero inoxidable Ref.: 8077060 3,89 €/un.
	POLEA PARA MOTOR GLYDEA™ Conjunto de polea para utilizar en el lado del motor Ref.: 8071060 8,96 €/un.		CORREA DE 100 m. PARA GLYDEA™ Correa de regulación con cable tensor con núcleo de acero 5, con tejido en la parte trasera y los dientes Ref.: 8072000 7,05 €/un.		BRAZO DE SOLAPACIÓN GLYDEA™ Acero inoxidable con rodillo Ref.: 8078400 12,62 €/un.
	TOPE DE POLEA GLYDEA™ Conjunto de tope de polea de repuesto como kit Ref.: 8087000 1,12 €/un.		TAPA DE POLEA GLYDEA™ Pieza de repuesto de la cubierta de polea Ref.: 8088060 0,83 €/un.		CORREDOR CON EJE ROTATIVO GLYDEA™ Carga máxima de 1,5 Kg Ref.: 8075060 0,65 €/un.
	RIEL DE CORTINA 5 m. GLYDEA™ Perfil de aluminio de riel Glydea de 5 m de longitud Ref.: 7478060 61,54 €/barra 14,77 €/m.		TRANSPORTADOR MAESTRO GLYDEA™ Aplicable a todos los motores Ref.: 8073060 15,88 €/un.		GANCHO PARA MOTOR GLYDEA™ Una unidad para rieles de un sentido, dos para rieles de dos sentidos Ref.: 8079060 0,62 €/un.

LOS PRECIOS DE LOS PRODUCTOS SOMFY SON NETOS

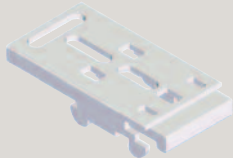
2. Elección de soportes para el montaje (se recomienda uno cada 50 cm.)

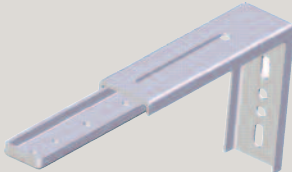
	SOPORTE DE TECHO GIRATORIO GLYDEA™			SOPORTE DE TECHO ONE TOUCH GLYDEA™	
	Soporte de techo para minimizar el paso de luz (máx. 2 mm)			Para una fácil instalación	
	Ref.: 8080400	0,92 €/un.		Ref.: 8081060	1,93 €/un.
	SOPORTE AJUSTABLE DE PARED GLYDEA™			SOP. DOBLE AJUSTABLE DE PARED GLYDEA™	
	Utilizado con cualquier soporte de techo			Utilizado con cualquier soporte de techo	
	Ref.: 8082060	3,99 €/un.		Ref.: 8083060	4,95 €/un.

NOTA: Los soportes ajustables de pared requieren un soporte de techo (se acoplan a cualquiera de los dos soportes ajustables)

3. Motor y componentes necesarios para la motorización

	MOTOR PARA MONTAJE POR RADIO CONTROL		REFERENCIA	PRECIO	MÓDULO RECEPTOR RTS 433 GLYDEA™	
	MOTOR 35 DCT: Contacto seco, unidad de cable de 1,5 m de 3 hilos (Para cortinas con peso hasta 35 kg.)		8064000	285,33 €/un.		Ref.: 8068000
	MOTOR 60 DCT: Contacto seco, unidad de cable de 1,5 m de 3 hilos (Para cortinas con peso hasta 60 kg.)		8066000	374,88 €/un.		65,38 €/un.









	MÓDULO RTS DE PARED TÁCTIL DE 1 CANAL	
	Módulo RTS de pared táctil de un canal (los marcos deben pedirse por separado) ★	
	Ref.: 8092000	50,20 €/un.

También disponible en negro

	MANDO A DISTANCIA DE 1 CANAL	
	Mando a distancia RTS de un canal	
	Ref.: 8093000	60,63 €/un.

	MANDO A DISTANCIA DE 4 CANALES	
	Mando a distancia RTS de 4 canales	
	Ref.: 8094000	87,59 €/un.

★ Los módulos RTS de pared tiene marcos en distintos colores que se sirven aparte:

							
Natural	Nogal	Teca	Roble	Negro	Cerezo	Plata	Plata mate
Ref.: 8012000	Ref.: 8012010	Ref.: 8012030	Ref.: 8012040	Ref.: 8012070	Ref.: 8012110	Ref.: 8012400	Ref.: 8012420
2,67 €/un.	27,83 €/un.	27,83 €/un.	27,83 €/un.	9,10 €/un.	27,83 €/un.	9,10 €/un.	9,10 €/un.

	MOTOR PARA MONTAJE CONTROL POR CABLE		REFERENCIA	PRECIO
	MOTOR 35 WT: Control de conmutación CA, unidad de cable de 1,5 m de 4 hilos (Para cortinas con peso hasta 35 kg.)		8065000	268,55 €/un.
	MOTOR 60 WT: Control de conmutación CA, unidad de cable de 1,5 m de 4 hilos (Para cortinas con peso hasta 60 kg.)		8067000	352,49 €/un.

	PULSADOR FIJO INDIVIDUAL	
	Interruptor mantenido mediante control individual	
	Ref.: 8090000	19,07 €/un.

	PULSADOR FIJO INDIVIDUAL CA	
	Control de CA individual con conexión de bus de control principal	
	Ref.: 8095000	108,26 €/un.

	PULSADOR FIJO INDIVIDUAL CONTROL CA	
	Interruptor de contacto seco para control principal de bus	
	Ref.: 8096000	43,26 €/un.

	TEMPORIZADOR GLYDEA™	
	Temporizador para control de línea de bus principal	
	Ref.: 8042000	120,49 €/un.

LOS PRECIOS DE LOS PRODUCTOS SOMFY SON NETOS

GAMA DE MOTORIZACIÓN DE CORTINAS "CHYC"



RIEL CHYC, incluye en su catálogo 2017, esta línea de rieles motorizados de la marca **CHYC**.





RIEL MOTORIZADO "CHYC" CON MANDO A DISTANCIA

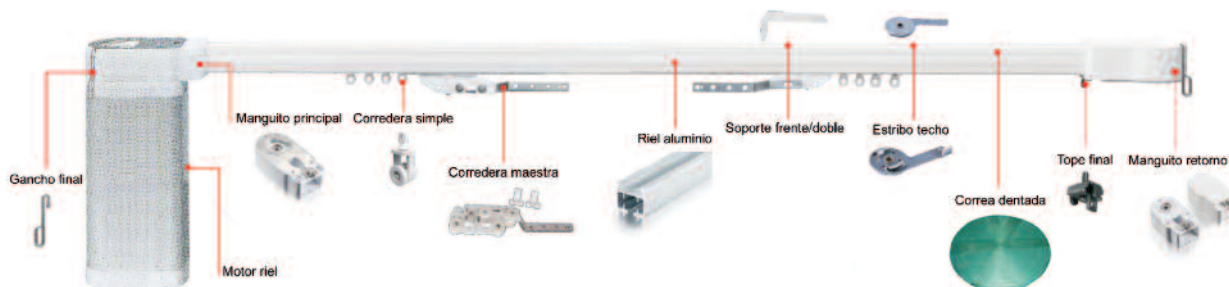

REFERENCIA	<---->	NÚMERO DE SOPORTES	P.V.P. SOPORTE TECHO		P.V.P. SOPORTE PARED	
			APER. LATERAL	APER. CENTRAL	APER. LATERAL	APER. CENTRAL
8200100	Riel motorizado "CHYC" hasta 100 cm.	2	502,13 €	515,71 €	512,02 €	525,60 €
8200120	Riel motorizado "CHYC" 100-120 cm.	2	511,30 €	524,88 €	521,19 €	534,77 €
8200140	Riel motorizado "CHYC" 121-140 cm.	3	520,46 €	534,04 €	535,31 €	548,89 €
8200160	Riel motorizado "CHYC" 141-160 cm.	3	529,63 €	543,21 €	544,48 €	558,05 €
8200180	Riel motorizado "CHYC" 161-180 cm.	3	538,80 €	552,38 €	553,64 €	567,22 €
8200200	Riel motorizado "CHYC" 181-200 cm.	4	547,97 €	561,55 €	567,76 €	581,34 €
8200220	Riel motorizado "CHYC" 201-220 cm.	4	557,14 €	570,72 €	576,93 €	590,51 €
8200240	Riel motorizado "CHYC" 221-240 cm.	4	566,31 €	579,89 €	586,10 €	599,68 €
8200260	Riel motorizado "CHYC" 241-260 cm.	5	575,48 €	589,06 €	600,21 €	613,79 €
8200280	Riel motorizado "CHYC" 261-280 cm.	5	584,64 €	598,22 €	609,38 €	622,96 €
8200300	Riel motorizado "CHYC" 281-300 cm.	5	593,81 €	607,39 €	618,55 €	632,13 €
8200320	Riel motorizado "CHYC" 301-320 cm.	6	602,98 €	616,56 €	632,67 €	646,25 €
8200340	Riel motorizado "CHYC" 321-340 cm.	6	612,15 €	625,73 €	641,83 €	655,41 €
8200360	Riel motorizado "CHYC" 341-360 cm.	6	621,32 €	634,90 €	651,00 €	664,58 €
8200380	Riel motorizado "CHYC" 361-380 cm.	7	630,49 €	644,07 €	665,12 €	678,70 €
8200400	Riel motorizado "CHYC" 381-400 cm.	7	639,66 €	653,24 €	674,29 €	687,87 €
8200420	Riel motorizado "CHYC" 401-420 cm.	7	648,82 €	662,40 €	683,46 €	697,04 €
8200440	Riel motorizado "CHYC" 421-440 cm.	8	657,99 €	671,57 €	697,57 €	711,15 €
8200460	Riel motorizado "CHYC" 441-460 cm.	8	667,16 €	680,74 €	706,74 €	720,32 €
8200480	Riel motorizado "CHYC" 461-480 cm.	8	676,33 €	689,91 €	715,91 €	729,49 €
8200500	Riel motorizado "CHYC" 481-500 cm.	9	685,50 €	699,08 €	730,03 €	743,61 €
8200520	Riel motorizado "CHYC" 501-520 cm.	9	694,67 €	708,25 €	739,19 €	752,77 €
8200540	Riel motorizado "CHYC" 521-540 cm.	9	703,84 €	717,42 €	748,36 €	761,94 €
8200560	Riel motorizado "CHYC" 541-560 cm.	10	713,00 €	726,58 €	762,48 €	776,06 €
8200580	Riel motorizado "CHYC" 561-580 cm.	10	722,17 €	735,75 €	771,65 €	785,23 €
8200600	Riel motorizado "CHYC" 581-600 cm.	10	731,34 €	744,92 €	780,82 €	794,40 €
8200620	Riel motorizado "CHYC" 601-620 cm.	11	740,51 €	754,09 €	794,93 €	808,51 €
8200640	Riel motorizado "CHYC" 621-640 cm.	11	749,68 €	763,26 €	804,10 €	817,68 €
8200660	Riel motorizado "CHYC" 641-660 cm.	11	758,85 €	772,43 €	813,27 €	826,85 €
8200680	Riel motorizado "CHYC" 661-680 cm.	12	768,02 €	781,60 €	827,39 €	840,97 €
8200700	Riel motorizado "CHYC" 681-700 cm.	12	777,18 €	790,76 €	836,55 €	850,13 €
8200720	Riel motorizado "CHYC" 701-720 cm.	12	786,35 €	799,93 €	845,72 €	859,30 €
8200740	Riel motorizado "CHYC" 721-740 cm.	13	795,52 €	809,10 €	859,84 €	873,42 €
8200760	Riel motorizado "CHYC" 741-760 cm.	13	804,69 €	818,27 €	869,01 €	882,59 €
8200780	Riel motorizado "CHYC" 761-780 cm.	13	813,86 €	827,44 €	878,18 €	891,76 €
8200800	Riel motorizado "CHYC" 781-800 cm.	14	823,03 €	836,61 €	892,29 €	905,87 €
8200820	Riel motorizado "CHYC" 801-820 cm.	14	832,20 €	845,78 €	901,46 €	915,04 €
8200840	Riel motorizado "CHYC" 821-840 cm.	14	841,36 €	854,94 €	910,63 €	924,21 €
8200860	Riel motorizado "CHYC" 841-860 cm.	15	850,53 €	864,11 €	924,75 €	938,33 €
8200880	Riel motorizado "CHYC" 861-880 cm.	15	859,70 €	873,28 €	933,91 €	947,49 €
8200900	Riel motorizado "CHYC" 881-900 cm.	15	868,87 €	882,45 €	943,08 €	956,66 €
8200920	Riel motorizado "CHYC" 901-920 cm.	16	878,04 €	891,62 €	957,20 €	970,78 €
8200940	Riel motorizado "CHYC" 921-940 cm.	16	887,21 €	900,79 €	966,37 €	979,95 €
8200960	Riel motorizado "CHYC" 941-960 cm.	16	896,38 €	909,96 €	975,54 €	989,12 €
8200980	Riel motorizado "CHYC" 961-980 cm.	17	905,54 €	919,12 €	989,65 €	1.003,23 €
8201000	Riel motorizado "CHYC" 981-1000 cm.	17	914,71 €	928,29 €	998,82 €	1.012,40 €
8201020	Riel motorizado "CHYC" 1001-1020 cm.	17	923,88 €	937,46 €	1.007,99 €	1.021,57 €
8201040	Riel motorizado "CHYC" 1021-1040 cm.	18	933,05 €	946,63 €	1.022,11 €	1.035,69 €
8201060	Riel motorizado "CHYC" 1041-1060 cm.	18	942,22 €	955,80 €	1.031,27 €	1.044,85 €
8201080	Riel motorizado "CHYC" 1061-1080 cm.	18	951,39 €	964,97 €	1.040,44 €	1.054,02 €
8201100	Riel motorizado "CHYC" 1081-1100 cm.	19	960,56 €	974,14 €	1.054,56 €	1.068,14 €
8201120	Riel motorizado "CHYC" 1101-1120 cm.	19	969,72 €	983,30 €	1.063,73 €	1.077,31 €
8201140	Riel motorizado "CHYC" 1121-1140 cm.	19	978,89 €	992,47 €	1.072,90 €	1.086,48 €
8201160	Riel motorizado "CHYC" 1141-1160 cm.	20	988,06 €	1.001,64 €	1.087,01 €	1.100,59 €
8201180	Riel motorizado "CHYC" 1161-1180 cm.	20	997,23 €	1.010,81 €	1.096,18 €	1.109,76 €
8201200	Riel motorizado "CHYC" 1181-1200 cm.	20	1.006,40 €	1.019,98 €	1.105,35 €	1.118,93 €

1. Esta tarifa incorpora **P.V.P.** de riel motorizado con mando a distancia individual, fijación con soporte a techo o a pared y apertura lateral o central para cada tipo de fijación. Si desea incluir variables como soporte doble u otro tipo de mando, **CONSULTAR.**
2. El riel se programará y se probará en nuestras instalaciones y será remitido al cliente preparado para su colocación.
3. El plazo de entrega es de 5 días hábiles desde la confirmación del pedido.



ACCESORIOS OPCIONALES

MOTOR RIEL MCHYC



EMISOR 1 CANAL MCHYC



EMISOR 2 CANALES MCHYC



EMISOR 6 CANALES MCHYC



EMISOR 16 CANALES MCHYC



REF.	8201000	8202000	8203000	8262000	8263000
	x 1	x 1	x 1	x 1	x 1
PRECIO NETO	117,60 €/U. (Neto)	25,23 €/U. (Neto)	27,06 €/U. (Neto)	21,86 €/U. (Neto)	33,60 €/U. (Neto)

EMPALME PERFIL MCHYC

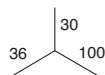

CORREDERA SIMPLE RIEL MCHYC



SOPORTE FRENTE RIEL MCHYC

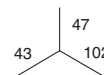
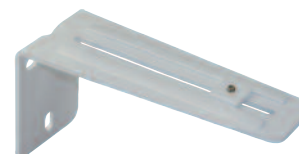

REF.	8207060	8208060	8209060
	x 200	x 2500	x 200
PRECIO NETO	6,33 €/U. (Neto)	0,28 €/U. (Neto)	3,08 €/U. (Neto)

SOPORTE DOBLE RIEL MCHYC

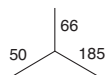
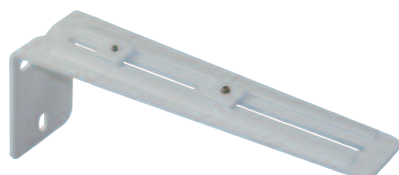

ESTRIBO TECHO RIEL MCHYC



GANCHO FINAL RIEL MCHYC

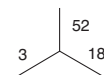

REF.	8210060	8211400	8215400
	x 200	x 100	x 500
PRECIO NETO	4,53 €/U. (Neto)	2,43 €/U. (Neto)	1,81 €/U. (Neto)

** Colores: 06= Blanco. 40= Plata.
Código de envasado: 0= Granel.

INSTRUCCIONES RIEL MOTORIZADO CHYC-AM95



MODOS DE CONTROL DEL MOTOR (UNA O DOS CORREDERAS)

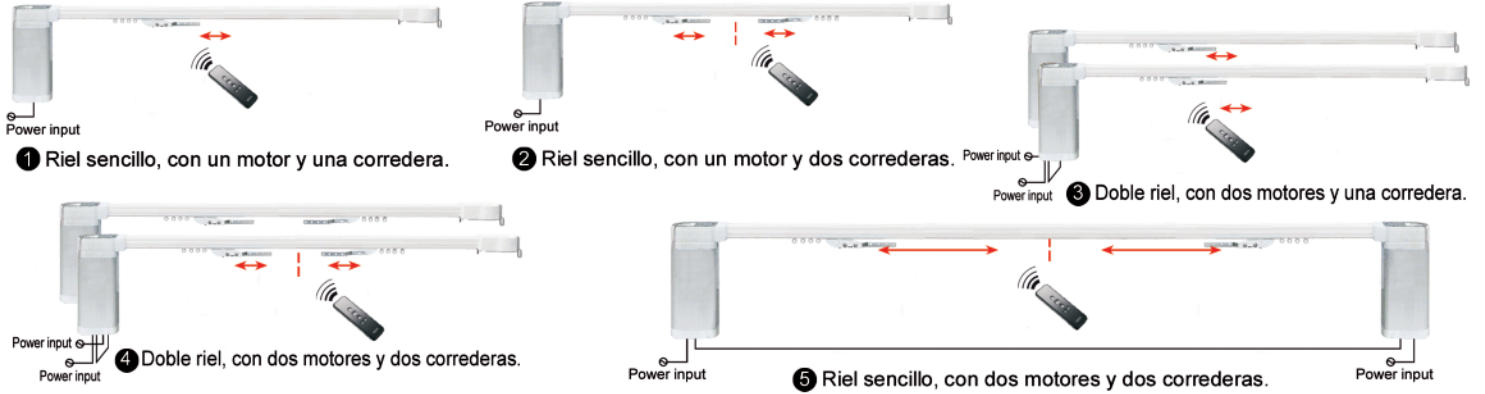

CARACTERÍSTICAS DEL MOTOR

- Diseño super silencioso:** Arranque y parada muy silenciosos. Movimiento elegante de la cortina.
- Parada por bloqueo:** La cortina se para automáticamente cuando la corredera nota resistencia al avance.
- Múltiples conexiones:** El interface standard soporta la conexión de varios motores que pueden ser accionados por interruptores externos o un sólo control central.
- Función "Light touch":** Al mover la cortina 5 cm., el motor se pone en marcha de forma automática.
- Varios modos de control:** Radiofrecuencia, cable, RS232/485, etc...
- Velocidad ajustable:** Posibilidad de ajustar tres velocidades diferentes.
- Operación manual:** Posibilidad de abrir y cerrar la cortina con el motor parado.
- Límites de recorrido autoajustables:** Memoriza las posiciones de final de recorrido de la cortina, para proteger los componentes y evitar daños en los mismos.

CARACTERÍSTICAS DEL RIEL

- Nivel de ruido menor de 30 dB en el motor principal.
- Antena oculta de gran sensibilidad.
- Uso de rodamientos de bolas para asegurar un movimiento equilibrado y silencioso.
- Manguitos con doble rodamiento de bolas para asegurar un sistema equilibrado y silencioso.
- 304 Estribos a techo con estructura oculta en acero inoxidable AISI304.
- El motor puede ser instalado indistintamente por debajo o por encima del manguito.

PARÁMETROS:

MODELO N°	PAR MOTOR	VELOCIDAD	TAMAÑO MOTOR	VOLTAJE	POTENCIA	PROTECCIÓN
AM95-1/100-ML-P	1N.m	16cm/s	215,5x94x56mm.	AC100-240V 50/60Hz	96W	IP20

ESQUEMA DE CARGA

UN SOLO MOTOR	1N.m			DOS MOTORES	1N.m
	LONGITUD DEL RIEL				LONGITUD DEL RIEL
PESO DE LA TELA MOTOR Y CORREDERA	4 m.	8 m.	12 m.	PESO DE LA TELA MOTOR Y CORREDERA	12 m.
Un solo motor con dos correderas	60 Kg.	55 Kg.	50 Kg.	Dos motores con dos correderas	90 Kg.
Un solo motor con una corredera	50 Kg.	45 Kg.	40 Kg.	Dos motores con una corredera	70 Kg.
Un solo motor con dos correderas	45 Kg.	40 Kg.	35 Kg.	Dos motores con dos correderas	60 Kg.
Un solo motor con una corredera	40 Kg.	35 Kg.	30 Kg.	Dos motores con una corredera	50 Kg.
Un solo motor con dos correderas	35 Kg.	30 Kg.	25 Kg.	Dos motores con dos correderas	40 Kg.
Un solo motor con una corredera	30 Kg.	25 Kg.	20 Kg.	Dos motores con una corredera	30 Kg.
Un solo motor con dos correderas	31 Kg.	21 Kg.		Dos motores con dos correderas	30 Kg.
Un solo motor con una corredera	21 Kg.	16 Kg.		Dos motores con una corredera	23 Kg.

OBSERVACIÓN:

La carga máxima de peso en los esquemas no incluye la fricción entre la tela y el riel de la cortina.

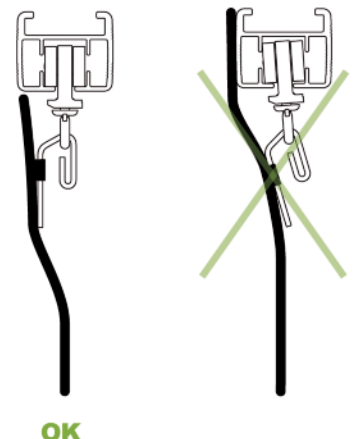

Peso de la tela= peso por m² (Kg/m²) x tamaño (m²) x rapport.

INSTRUCCIONES RIEL MOTORIZADO CHYC-AM95



INSTALACIÓN DEL MOTOR

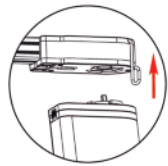

Insertar el motor en el manguito principal

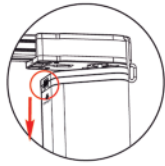

Mantener pulsado el botón de bloqueo, girar el motor y soltar el botón.

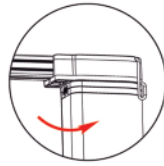

Instalación terminada.

DESINSTALACIÓN DEL MOTOR

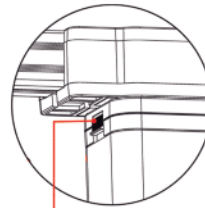

BOTÓN DE BLOQUEO

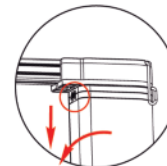

Mantener pulsado el botón de bloqueo, girar el motor para desconectarlo del manguito principal y soltar el botón. Sacar el motor.

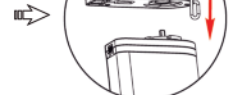

Precaución: Por favor, seguir los pasos de instalación. El techo debe de ser lo suficientemente fuerte para soportar el peso del riel, el motor y la tela.

INSTALACIÓN DEL SOPORTE FRENTE

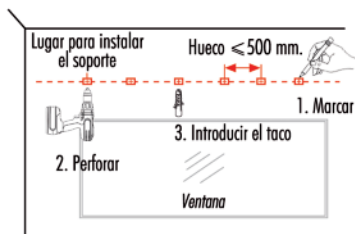

1. Marcar y hacer los agujeros

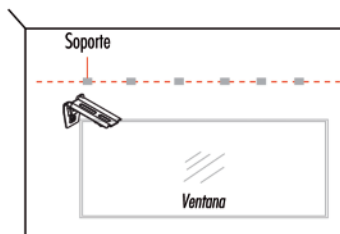

2. Instalar el soporte frente

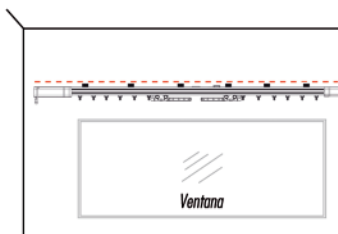

3. Instalar el riel

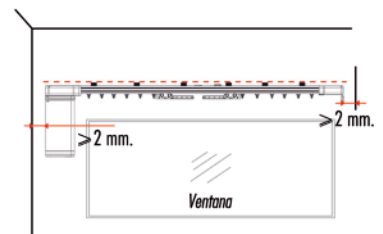

4. Instalar el motor

INSTALACIÓN DEL SOPORTE TECHO

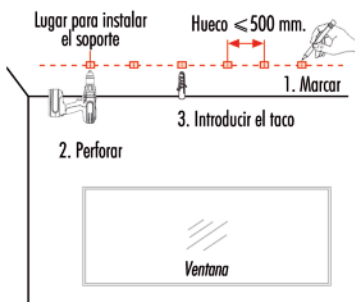

1. Marcar y hacer los agujeros

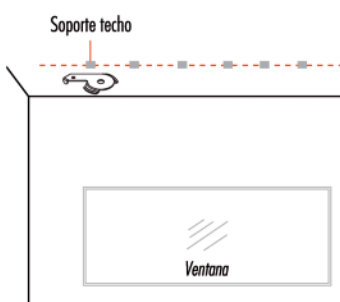

2. Instalar el soporte techo

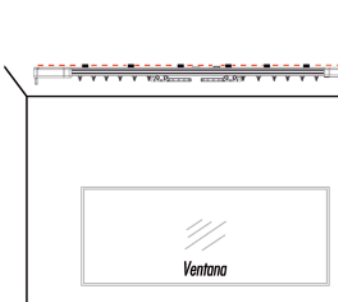

3. Instalar el riel

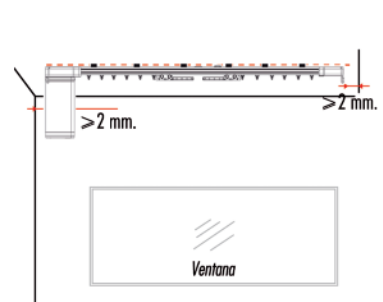

4. Instalar el motor

INSTALACIÓN CON MOLDURAS

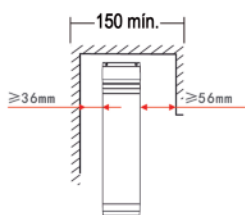

Instalación de un riel

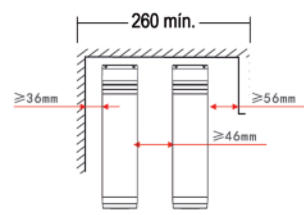

Instalación de dos rieles (2 cortinas)

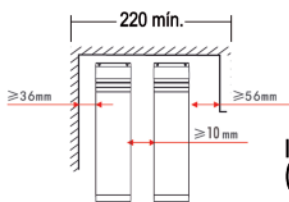

Instalación de dos rieles (Cortinas + visillo)

CABLEADO

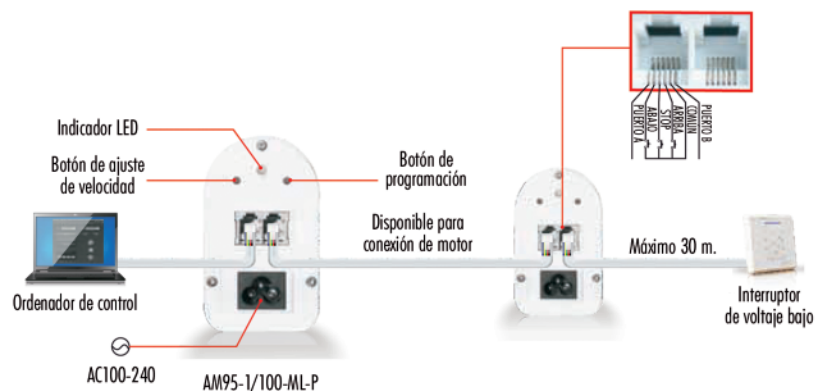

Precaución:

- El interruptor externo manual es de contacto seco.
- Los puertos serie A y B tienen la misma función.